

**PROJECT AGREEMENT
(Redacted Version)**

**TO DESIGN, BUILD AND FINANCE
REGIONAL EXPRESS RAIL
DAVENPORT DIAMOND**

CONFIDENTIAL

TABLE OF CONTENTS

1.	DEFINITIONS AND INTERPRETATION	2
1.1	Definitions and Interpretation	2
1.2	Conflict of Terms	4
1.3	Conflict of Documents	5
1.4	Legal Requirements	5
2.	COMMERCIAL CLOSE AND FINANCIAL CLOSE	5
2.1	Effective Date	5
2.2	Standby Letter of Credit	5
2.3	Financial Close	6
2.4	Disruption in Financial Markets	7
3.	GUARANTEED PRICE	8
3.1	Guaranteed Price and Adjustments	8
3.2	[Not Used].....	9
4.	PAYMENT	9
4.1	General.....	9
4.2	Acknowledgement by Project Co	9
4.3	Lump Sum Payments	9
4.4	Directions of Payments	9
4.5	Payment of Legislative Holdback.....	10
4.6	Payment of Finishing Holdback.....	11
4.7	Completion Holdback and Seasonal Works Holdback	12
4.8	Compensation on Termination.....	13
4.9	Payment Due under Insurance Policies.....	13
4.10	HST.....	13
4.11	Set-Off	13
4.12	Effect of Payment	14
4.13	No Other Entitlement.....	14
4.14	Taxes.....	14
4.15	Changes in Scope of Taxation	15
4.16	Changes in Recoverability of Tax Credits	15
4.17	Information and Assistance Provided by Project Co	15
4.18	Residency – Income Tax Act (Canada)	16
4.19	Taxes – General	16
4.20	Taxes – Indemnity	16
4.21	Cost Adjustment – Utilities.....	17
5.	SCOPE OF AGREEMENT	18
5.1	Scope of Agreement.....	18
6.	REPRESENTATIONS AND WARRANTIES.....	18
6.1	Project Co Representations and Warranties.....	18
6.2	Contracting Authority Representations and Warranties	21
7.	BACKGROUND INFORMATION	24
7.1	No Liability.....	24
7.2	No Warranty	24

7.3	No Claims	25
7.4	Technical Reports	25
8.	PROJECT DOCUMENTS.....	25
8.1	Project Documents.....	25
8.2	Ancillary Documents.....	26
8.3	Changes to Lending Agreements and Refinancing.....	26
8.4	Compliance with Lending Agreements	27
9.	CONTRACTING AUTHORITY RESPONSIBILITIES.....	27
9.1	General.....	27
10.	PROJECT CO RESPONSIBILITIES – GENERAL	28
10.1	Other Business	28
10.2	Complete and Operational New Metrolinx Infrastructure and New Third Party Infrastructure.....	28
10.3	General Responsibilities and Standards.....	28
11.	PROJECT CO RESPONSIBILITIES – DESIGN AND CONSTRUCTION.....	30
11.1	Development of Design	30
11.2	Start-Up Meeting	32
11.3	Design Workshops.....	33
11.4	Performance of Design Obligations.....	35
11.5	Works Submittals.....	35
11.6	Documents	35
11.7	General Construction Obligations.....	36
11.8	Permits, Licences, Approvals and Agreements	37
11.9	Protection of Works and Property.....	40
11.10	Liability Unaffected.....	42
11.11	Safety	42
11.12	Additional Works and Third Party Works	45
11.13	Protest and Trespass.....	48
11.14	Adjacent Developments	49
11.15	Defective Works	49
11.16	Warranty Obligations.....	50
11.17	Warranty Work and Prompt Repair of Warranty Work.....	52
11.18	Warranty Letter of Credit.....	53
11.19	Coordination and Minimization of Disruption and Interference.....	55
11.20	Substitutions.....	57
11.21	Change in Standards	57
11.22	Subcontractors and Suppliers.....	57
11.23	Apprenticeship Plan and Program	58
11.24	Intentionally Deleted.....	59
11.25	COR Certification.....	59
11.26	Demolition Requirements	62
11.27	Liquidated Damages and Construction Enforcement Regime	64
11.28	Works, Goods, Equipment, Consumables and Materials.....	64
11.29	GO Passenger Charter.....	64
11.30	Tracking System	64

12.	REPRESENTATIVES.....	66
12.1	The Contracting Authority Representative.....	66
12.2	The Project Co Representative.....	67
12.3	Communications to Representatives.....	67
12.4	Key Individuals.....	67
13.	WORKS SCHEDULE REQUIREMENTS AND WORKS REPORT.....	68
13.1	Completion of the Works.....	68
13.2	Works Schedule Requirements.....	69
13.3	Intentionally Deleted.....	69
13.4	Notification of Early Interim Completion.....	69
13.5	Notification of Early Substantial Completion.....	69
13.6	Works Report.....	70
14.	WORKS COMMITTEE.....	71
14.1	Establishment.....	71
14.2	Function and Role.....	71
14.3	Term of Works Committee.....	72
14.4	Replacement of Committee Members.....	72
14.5	Procedures and Practices.....	73
14.6	Proceeding at Risk.....	74
15.	QUALITY MANAGEMENT.....	75
15.1	Quality Management.....	75
16.	ACCESS TO THE METROLINX LANDS.....	77
16.1	Access to Metrolinx Lands.....	77
16.2	Non-Exclusive Rights to Metrolinx Lands and Development of Lands.....	78
16.3	Limited Access Areas.....	79
16.4	Naming and Signage.....	79
16.5	No Interest in Land, Facilities or Infrastructure.....	80
16.6	Non-Disturbance Agreement.....	80
16.7	Adjustments to Metrolinx Lands Available to Project Co.....	80
16.8	Changes to Lands.....	81
17.	ENCUMBRANCES.....	81
17.1	Project Co Shall Perform Obligations Under Encumbrances.....	81
17.2	No Encumbrances.....	81
17.3	Construction Act (Ontario).....	83
18.	SITE CONDITION.....	84
18.1	Acceptance of Site Condition.....	84
18.2	Contamination.....	85
18.3	Items of Geological, Historical or Archaeological Interest or Value.....	89
18.4	Unknown Utility Infrastructure.....	91
18.5	Species-at-Risk.....	91
19.	GOVERNMENTAL AND THIRD PARTY FINANCIAL OBLIGATIONS.....	92
19.1	Governmental, Railway and Utility Company Fees.....	92

20.	CONTRACTING AUTHORITY ACCESS AND MONITORING	93
20.1	Contracting Authority Access During the Works	93
20.2	Increased Monitoring	94
20.3	Right to Uncover	94
20.4	No Relief from Obligations	95
20.5	Access by Others	95
20.6	Public Use	97
20.7	Executive Project Meetings	97
21.	SUSTAINABILITY AND ENVIRONMENTAL REQUIREMENTS	99
21.1	Sustainability Requirements	99
21.2	Environmental Requirements	99
22.	INDEPENDENT CERTIFIER	99
22.1	Appointment	99
22.2	Role of Independent Certifier	99
22.3	Changes to Terms of Appointment	99
22.4	Right to Change Appointment	100
22.5	Cooperation	100
22.6	Payment of Independent Certifier	100
22.7	Replacement	100
23.	INTENTIONALLY DELETED	101
24.	INTERIM COMPLETION COMMISSIONING AND COMPLETION	101
24.1	Interim Completion Commissioning Activities	101
24.2	Interim Completion Commissioning Program	101
24.3	Commencement of Interim Completion Project Co Commissioning	102
24.4	Interim Completion Certificate	102
24.5	Operation and Maintenance Manuals – Interim Completion Works	104
24.6	Intentionally Deleted	105
24.7	Interim Completion Contracting Authority Commissioning	105
24.8	Interim Completion Countdown Notice and Completion Deliverables	105
24.9	Interim Completion Minor Deficiencies	106
24.10	Rectification of Interim Completion Minor Deficiencies	107
24.11	Failure to Rectify Interim Completion Minor Deficiencies	107
24.12	Effect of Certificate/Use	108
25.	COMMISSIONING AND COMPLETION	108
25.1	Commissioning Activities	108
25.2	Final Commissioning Program	108
25.3	Commencement of Project Co Commissioning	109
25.4	Substantial Completion Certificate	110
25.5	Operation and Maintenance Manuals	112
25.6	Maintenance Instructions	112
25.7	Contracting Authority Commissioning	113
25.8	Countdown Notice and Substantial Completion Deliverables	113
25.9	Minor Deficiencies	114
25.10	Completion and Rectification of Minor Deficiencies	115
25.11	Failure to Rectify Minor Deficiencies	116
25.12	Final Completion Countdown Notice	117

25.13	Final Completion Certificate.....	118
25.14	Effect of Certificates/Use.....	119
25.15	Inspection, Commissioning and Handover of [REDACTED].....	120
25A.	MILESTONE PAYMENTS	123
25A.1	Milestone Payment Completion Countdown Notice	123
25A.2	Certification of Milestone Payments	123
26.	HUMAN RESOURCES	124
26.1	Admittance of Personnel.....	124
26.2	Staff Competency	125
26.3	Notification of Convictions.....	125
26.4	Disciplinary Action.....	126
26.5	Human Resources Policies.....	126
26.6	Management Organizations	126
26.7	Governmental Authority	126
27.	CONTRACTING AUTHORITY’S REMEDIAL RIGHTS	127
27.1	Exercise of Remedial Rights.....	127
27.2	Emergency	128
27.3	Rectification.....	128
27.4	Costs and Expenses.....	129
27.5	Reimbursement Events	129
27.6	Reimbursement if Improper Exercise of Rights	129
28.	RECORDS, INFORMATION AND AUDIT	130
28.1	Records Provisions	130
28.2	Information and General Audit Rights	130
28.3	Lenders’ Consultant Reports.....	132
29.	COMMUNICATIONS	132
29.1	Communications	132
30.	CHANGES IN LAW	132
30.1	Performance after Change in Law	132
30.2	Works Change in Law	132
30.3	Relevant Change in Law	133
31.	VARIATIONS	134
31.1	Variation Procedure	134
31.2	Innovation and Value Engineering	135
32.	DELAY EVENTS.....	137
32.1	Definition.....	137
32.2	Consequences of a Delay Event.....	140
32.3	Mitigation.....	143
33.	COMPENSATION EVENTS.....	144
33.1	Definition.....	144
33.2	Consequences of a Compensation Event	144
33.3	Mitigation.....	145

33.4	Insured Exposure	145
33.5	Intentionally Deleted.....	146
33.6	Special Compensation Regarding Category 1 Utility Company.....	146
34.	RELIEF EVENTS.....	147
34.1	Definition.....	147
34.2	Consequences of a Relief Event	148
34.3	Mitigation and Process.....	148
34.4	Insured Exposure	149
35.	FORCE MAJEURE	149
35.1	Definition.....	149
35.2	Consequences of Force Majeure.....	150
35.3	Mitigation and Process.....	150
35.4	Insured Exposure	151
35.5	Modifications	151
36.	PROJECT CO DEFAULT.....	151
36.1	Project Co Events of Default	151
36.2	Notification of Occurrence	155
36.3	Right to Termination.....	155
36.4	Remedy Provisions	155
36.5	Contracting Authority Costs	156
36.6	No Other Rights to Terminate.....	157
37.	CONTRACTING AUTHORITY DEFAULT	157
37.1	Contracting Authority Events of Default.....	157
37.2	Project Co's Options.....	157
37.3	Project Co's Costs.....	158
37.4	No Other Rights to Terminate.....	158
38.	RELIEF EVENT AND NON DEFAULT TERMINATION.....	158
38.1	Termination for Relief Event.....	158
38.2	Termination for Force Majeure.....	158
38.3	Termination for Convenience	159
38.4	Automatic Expiry on Expiry Date	159
39.	EFFECT OF TERMINATION	159
39.1	Termination.....	159
39.2	Continued Effect – No Waiver	159
39.3	Continuing Performance	159
39.4	Effect of Notice of Termination.....	159
39.5	Ownership of Information.....	161
39.6	Provision in Subcontracts	161
39.7	Transitional Arrangements.....	161
39.8	Termination upon Aforesaid Transfer	162
39.9	Survival.....	162
40.	COMPENSATION ON TERMINATION.....	163
40.1	Compensation on Termination.....	163
40.2	Full and Final Settlement	163

41.	INTELLECTUAL PROPERTY	163
41.1	Ownership of Intellectual Property	163
41.2	Licenses to Intellectual Property	163
41.3	Representation and Warranty	164
41.4	Jointly Developed Materials	164
41.5	Maintenance of Data	165
41.6	Contracting Authority Trade-Marks	166
41.7	Confidential Information	166
41.8	Government Use of Documents	166
41.9	Restrictions	166
42.	CONFIDENTIALITY	167
42.1	Disclosure	167
42.2	Redaction	168
42.3	Disclosure to Government	168
42.4	Freedom of Information and Protection of Privacy Acts	168
42.5	Use and Disclosure of Confidential Information	169
42.6	Exceptions	170
42.7	Survival of Confidentiality	171
42.8	Confidentiality of Intellectual Property	171
43.	PERSONAL INFORMATION	171
43.1	General	171
43.2	Protection of Personal Information	172
43.3	Personal Information	172
44.	INSURANCE AND PERFORMANCE SECURITY	173
44.1	General Requirements	173
44.2	No Relief from Liabilities and Obligations	173
44.3	Performance Guarantee of Construction Guarantor	173
45.	TITLE	173
45.1	Title	173
46.	INDEMNITIES	174
46.1	Project Co Indemnities to Contracting Authority	174
46.2	Contracting Authority Indemnities to Project Co	177
46.3	Conduct of Claims	178
46.4	Mitigation – Indemnity Claims	180
47.	LIMITS ON LIABILITY	180
47.1	Indirect Losses	180
47.2	No Liability in Tort	181
47.3	Sole Remedy	181
47.4	Maximum Liability	183
48.	DISPUTE RESOLUTION PROCEDURE	183
49.	ASSIGNMENT, SUBCONTRACTING AND CHANGES IN CONTROL	183
49.1	Project Co Assignment	183
49.2	Contracting Authority Assignment	184

49.3	Subcontracting	184
49.4	Changes in Ownership and Control	185
49.5	Contracting Authority’s Due Diligence	186
50.	PROHIBITED ACTS.....	187
50.1	Definition.....	187
50.2	Remedies.....	188
50.3	Permitted Payments	189
50.4	Notification	189
50.5	Replacement of Project Co Party	189
51.	NOTICES.....	189
51.1	Notices to Parties	189
51.2	Notices to Representatives.....	190
51.3	Facsimile.....	190
51.4	Change of Address.....	190
51.5	Deemed Receipt of Notices	190
51.6	Service on Contracting Authority	191
52.	EMERGENCY MATTERS	191
52.1	Emergency	191
53.	CONTRACTING AUTHORITY’S DESIGNATE.....	192
53.1	Right to Designate	192
54.	GENERAL.....	192
54.1	Amendments	192
54.2	Waiver.....	192
54.3	Relationship Between the Parties.....	193
54.4	General Duty to Mitigate	193
54.5	Actual Knowledge	193
54.6	Entire Agreement.....	194
54.7	No Reliance.....	194
54.8	Severability	194
54.9	Enurement.....	194
54.10	Governing Law and Jurisdiction.....	194
54.11	Cumulative Remedies	195
54.12	Further Assurance	195
54.13	Costs	195
54.14	Language of Agreement.....	195
54.15	Proof of Authority.....	195
54.16	Counterparts.....	195
54.17	Province Persons and Contracting Authority Parties as Third Party Beneficiaries	196
54.18	Time is of the Essence	196
54.19	Copyright Notice.....	196

SCHEDULES

Schedule No.	Description
Schedule 1	Definitions and Interpretation

Schedule No.	Description
Schedule 2	Completion Documents
Schedule 3	Subcontractor's Direct Agreement
Schedule 4	Lenders' Direct Agreement
Schedule 5	Construction Contractor's Direct Agreement
Schedule 6	Independent Certifier Agreement
Schedule 7	Letters of Credit
Schedule 8	Project Co Parties
Schedule 9	Key Individuals
Schedule 10	Review Procedure
Schedule 11	Quality Management
Schedule 12	Works Schedule Requirements
Schedule 13	Project Co Proposal Extracts
Schedule 14	Outline Commissioning Program and Handover
Schedule 15	Output Specifications
Schedule 16	Encumbrances
Schedule 17	Environmental Obligations
Schedule 18	Communication and Public Engagement Protocol
Schedule 19	Intentionally Deleted
Schedule 20	Lands
Schedule 21	Liquidated Damages and Construction Enforcement Regime
Schedule 22	Variation Procedure
Schedule 23	Compensation on Termination
Schedule 24	Intellectual Property
Schedule 25	Insurance and Performance Security Requirements
Schedule 26	Record Provisions
Schedule 27	Dispute Resolution Procedure
Schedule 28	Refinancing
Schedule 29	Form of Performance Guarantee of Construction Guarantor
Schedule 30	Insurance Trust Agreement
Schedule 31	Project Co Information
Schedule 32	[REDACTED]
Schedule 33	Works Report Requirements
Schedule 34	Rail Corridor Access and Flagging
Schedule 35	Contractor Site Specific Safety Manual Requirements

THIS PROJECT AGREEMENT is entered into as of July 25, 2019

BETWEEN:

ONTARIO INFRASTRUCTURE AND LANDS CORPORATION, a Crown agent, continued under the *Ontario Infrastructure and Lands Corporation Act, 2011*, S.O. 2011

AND:

METROLINX, a non-share capital corporation continued under the *Metrolinx Act, 2006*, S.O. 2006, c. 16 and a Crown agency within the meaning of the *Crown Agency Act*, R.S.O. 1990, c. 48, as amended in accordance with Section 3 of the *Metrolinx Act, 2006* (Ontario)

(collectively, “**Contracting Authority**”)

AND:

GCRS DAVENPORT GENERAL PARTNERSHIP, [REDACTED]

(“**Project Co**”)

WHEREAS:

- A. Metrolinx’s Regional Express Rail, which was announced in 2014 by the Province, is intended to transform the Greater Toronto and Hamilton Area over the next decade by introducing new and additional service on five of the seven GO Transit rail corridors.
- B. Contracting Authority wishes to procure the design, construction and financing of the Rail Grade Separation along the Rail Corridor in order to accommodate the anticipated Regional Express Rail services.
- C. Contracting Authority commenced the procurement process for the Works, which Works include the design, construction, and financing of the New Metrolinx Infrastructure and the New Third Party Infrastructure (the “**Project**”), by issuing a request for qualifications on August 17, 2017.
- D. Project Co will carry out the Works.
- E. Contracting Authority and Project Co wish to enter into this project agreement (the “**Project Agreement**”) which sets out the terms and conditions upon which Project Co shall perform the Works.
- F. The Project will proceed as an alternative financing and procurement project approved by MOI.
- G. As a result, the Project shall follow five fundamental principles which guide the financing and procurement of public infrastructure projects in Ontario:
 1. The public interest is paramount.
 2. Value for money must be demonstrable.

3. Appropriate public control/ownership must be preserved.
 4. Accountability must be maintained.
 5. All processes must be fair, transparent and efficient.
- H. Consistent with the principle of appropriate public ownership/control, public ownership of assets will be preserved in the public sector.
- I. With a view to ensuring that both Parties are able to properly and effectively discharge their respective duties, functions and responsibilities under Applicable Law, it is the intent that Contracting Authority and Project Co work collaboratively, responsibly and cooperatively throughout the Project Term.
- J. Contracting Authority intends to be liable, on a joint and several basis, for all of the obligations of Contracting Authority pursuant to this Project Agreement, save and except as provided for in this Project Agreement.

NOW THEREFORE in consideration of the mutual covenants and agreements of the Parties hereinafter contained and for other good and valuable consideration, the receipt and sufficiency of which are hereby acknowledged, the Parties covenant and agree as follows:

1. DEFINITIONS AND INTERPRETATION

1.1 Definitions and Interpretation

- (a) This Project Agreement shall be interpreted in accordance with Schedule 1 – Definitions and Interpretation.
- (b) This Project Agreement is comprised of this executed agreement and the following documents, all of which are hereby incorporated by reference into and form part of this Project Agreement:

Schedule No.	Description
Schedule 1	Definitions and Interpretation
Schedule 2	Completion Documents
Schedule 3	Subcontractor's Direct Agreement
Schedule 4	Lenders' Direct Agreement
Schedule 5	Construction Contractor's Direct Agreement
Schedule 6	Independent Certifier Agreement
Schedule 7	Letters of Credit
Schedule 8	Project Co Parties
Schedule 9	Key Individuals
Schedule 10	Review Procedure
Schedule 11	Quality Management
Schedule 12	Works Schedule Requirements
Schedule 13	Project Co Proposal Extracts
Schedule 14	Outline Commissioning Program and Handover

Schedule No.	Description
Schedule 15	Output Specifications
Schedule 16	Encumbrances
Schedule 17	Environmental Obligations
Schedule 18	Communication and Public Engagement Protocol
Schedule 19	Intentionally Deleted
Schedule 20	Lands
Schedule 21	Liquidated Damages and Construction Enforcement Regime
Schedule 22	Variation Procedure
Schedule 23	Compensation on Termination
Schedule 24	Intellectual Property
Schedule 25	Insurance and Performance Security Requirements
Schedule 26	Record Provisions
Schedule 27	Dispute Resolution Procedure
Schedule 28	Refinancing
Schedule 29	Form of Performance Guarantee of Construction Guarantor
Schedule 30	Insurance Trust Agreement
Schedule 31	Project Co Information
Schedule 32	[REDACTED]
Schedule 33	Works Report Requirements
Schedule 34	Rail Corridor Access and Flagging
Schedule 35	Contractor Site Specific Safety Manual Requirements

- (c) The documents comprising this Project Agreement are complementary and what is called for by any one of them shall be interpreted as if called for by all, except in the event of ambiguities, conflicts or inconsistencies, in which case Section 1.2 shall apply.
- (d) Except for those parts of Project Co's proposal which are, in the sole discretion of Contracting Authority, incorporated by explicit reference into this Project Agreement by the Project Co Proposal Extracts, on Financial Close the Request for Proposals and Project Co's proposal shall be superseded entirely by this Project Agreement and rendered null and void, and shall not be relied upon or used by Project Co, Contracting Authority or anyone else (including anyone pursuant to Schedule 27 – Dispute Resolution Procedure or any arbitral body or any court) in any way to interpret or qualify the scope of the Works, any obligations or liabilities of Project Co, or anything else contained in this Project Agreement.
- (e) Unless it is specifically provided that a consent, approval or satisfaction is in the sole discretion of Contracting Authority, no consent, approval or satisfaction of Contracting Authority or the Contracting Authority Representative shall be unreasonably withheld or delayed.
- (f) Unless it is specifically provided that a consent, approval or satisfaction is in the sole discretion of Project Co, no consent, approval or satisfaction of Project Co or the Project Co Representative shall be unreasonably withheld or delayed.

- (g) The organization of the Output Specifications into divisions, sections and parts shall not control Project Co in dividing the Works among the Project Co Parties or in establishing the extent of the Works to be performed by a trade.

1.2 Conflict of Terms

- (a) In the event of ambiguities, conflicts or inconsistencies between or among any of the provisions of this Project Agreement, the provisions shall govern in the following order of precedence with each taking precedence over those listed subsequently:
- (i) the provisions of amendments in writing to this Project Agreement signed by the Parties and Variation Confirmations shall govern and take precedence only over those specific provisions of this Project Agreement expressly amended thereby;
 - (ii) any provision establishing a higher standard of safety, reliability, durability, performance or service shall take precedence over a provision establishing a lower standard of safety, reliability, durability, performance or service;
 - (iii) the body of this Project Agreement;
 - (iv) Schedule 1 – Definitions and Interpretation;
 - (v) Appendix A to Schedule 1 – Permits, Licences, Approvals and Agreements;
 - (vi) Schedule 20 – Lands;
 - (vii) Schedule 27 – Dispute Resolution Procedure;
 - (viii) Schedule 21 – Liquidated Damages and Construction Enforcement Regime;
 - (ix) Schedule 34 – Rail Corridor Access and Flagging;
 - (x) Schedule 15 – Output Specifications;
 - (xi) Schedule 17 – Environmental Obligations;
 - (xii) Schedule 25 – Insurance and Performance Security Requirements;
 - (xiii) Schedule 22 – Variation Procedure;
 - (xiv) Schedule 10 – Review Procedure;
 - (xv) Schedule 14 – Outline Commissioning Program and Handover;
 - (xvi) Schedule 11 – Quality Management;
 - (xvii) Schedule 28 – Refinancing;
 - (xviii) Schedule 23 – Compensation on Termination;

- (xix) Schedule 26 – Record Provisions;
 - (xx) the other Schedules in the order in which they are listed in Section 1.1(b); and
 - (xxi) Schedule 13 – Project Co Proposal Extracts.
- (b) Subject to Section 1.2(a), if the ambiguity, conflict or inconsistency is between a provision of general application and a provision that applies only to a specific part of the Works, the provision that applies to the specific part of the Works shall govern for that specific part of the Works.
- (c) If any ambiguity, conflict or inconsistency is not readily resolved by the foregoing provisions of this Section 1.2, then Project Co or Contracting Authority, upon discovery of same, shall immediately give Notice to the Contracting Authority Representative. The Contracting Authority Representative shall, within 10 Business Days after such Notice, make a determination of which provision governs and give Notice of such determination, in writing, to Project Co.
- (d) Contracting Authority and Project Co shall comply with the determination of the Contracting Authority Representative pursuant to this Section 1.2 unless Contracting Authority or Project Co dispute the decision of the Contracting Authority Representative in which event such Dispute may be referred for resolution in accordance with Schedule 27 – Dispute Resolution Procedure.

1.3 Conflict of Documents

- (a) In the event of any ambiguity, conflict or inconsistency between the provisions of this Project Agreement and the Lenders’ Direct Agreement, the provisions of the Lenders’ Direct Agreement shall prevail and govern to the extent of such ambiguity, conflict or inconsistency. Notwithstanding the foregoing, if there is any right or remedy in favour of Contracting Authority set out in the Lenders’ Direct Agreement or any part thereof which is not set out or provided for in the Project Agreement, such additional right or remedy shall not constitute an ambiguity, conflict or inconsistency.

1.4 Legal Requirements

- (a) Whenever standards of Applicable Law differ, the most stringent standards shall govern.

2. COMMERCIAL CLOSE AND FINANCIAL CLOSE

2.1 Effective Date

- (a) The provisions of Sections 1.1, 1.2, 1.3, 1.4, 2.1, 2.2, 2.3, 2.4, 3.1, 4.14 to 4.20, 5 to 15, 16.5, 17 to 22, 26 to 31, and 41 to 54 and Schedules 1 (including Appendix A to Schedule 1 – Permits, Licences, Approvals and Agreements), 2, 7-13, 16-18, 20-22, 24-27, 32 and 34 of this Project Agreement will come into effect on the date of this Project Agreement (“**Commercial Close**”). All other provisions and schedules will come into effect only on Financial Close.

2.2 Standby Letter of Credit

- (a) If Project Co has provided Contracting Authority with multiple standby letters of credit in accordance with Section 9.1(2) of the RFP, for purposes of this Section 2.2 each of the multiple

irrevocable standby letters of credit is referred to as a Standby Letter of Credit for purposes of this Project Agreement.

- (b) Unless a Standby Letter of Credit is drawn by Contracting Authority in accordance with the provisions of this Project Agreement, Contracting Authority shall release and deliver the Standby Letter(s) of Credit to Project Co on Financial Close.
- (c) Project Co shall ensure that the Standby Letter(s) of Credit (and any replacement therefor) is renewed prior to its expiry date if, as at such date, Financial Close will not, or may reasonably be expected not to, have occurred.
- (d) If there are multiple Standby Letters of Credit, Project Co acknowledges and agrees that:
 - (i) Contracting Authority may draw upon any Standby Letter of Credit provided by any Letter of Credit Provider in any specified ratable amount;
 - (ii) Contracting Authority may draw on any Standby Letter of Credit provided by any Letter of Credit Provider in a disproportionate amount to such Letter of Credit Provider's contribution to security;
 - (iii) Contracting Authority may draw upon any Standby Letter of Credit provided by any Letter of Credit Provider even in the event that such Letter of Credit Provider is no longer a Project Co Party; and
 - (iv) the provision of multiple Standby Letters of Credit shall not in any way prejudice or adversely affect the rights of Contracting Authority to draw on the Standby Letter(s) of Credit in accordance with this Project Agreement, including in a circumstance where the default giving rise to Contracting Authority's right to draw on the Standby Letter(s) of Credit is not the result of any act or omission of the Letter of Credit Provider(s) whose Standby Letter of Credit is drawn upon.

2.3 Financial Close

- (a) No later than 30 days prior to the Financial Close Target Date, Project Co will deliver to Contracting Authority drafts of all documents referred to in Section 1 of Schedule 2 – Completion Documents.
- (b) On or before the Financial Close Target Date:
 - (i) Project Co shall deliver to Contracting Authority the documents referred to in Section 1 of Schedule 2 – Completion Documents; and
 - (ii) Contracting Authority shall deliver to Project Co the documents referred to in Section 2 of Schedule 2 – Completion Documents.
- (c) If Project Co fails to deliver to Contracting Authority any of the documents referred to in Section 1 of Schedule 2 – Completion Documents by the Financial Close Target Date (other than as a direct result of a breach by Contracting Authority of its obligations under Section 2.3(b)(ii)) and Contracting Authority does not waive such requirement, Contracting Authority will be entitled to

draw on the Standby Letter of Credit immediately, and to retain the proceeds thereof as liquidated damages, and may terminate this Project Agreement in its entirety by written Notice having immediate effect. The Parties agree that such liquidated damages are not a penalty but represent a genuine and reasonable pre-estimate of the damages that Contracting Authority will suffer as a result of the happening of the specified event. Such payment shall constitute full and final settlement of any and all damages that may be claimed by Contracting Authority as a result of Project Co not achieving Financial Close. The Parties agree that such liquidated damages shall be payable whether or not Contracting Authority incurs or mitigates its damages, and that Contracting Authority shall not have any obligation to mitigate any such damages.

- (d) If Contracting Authority fails to deliver to Project Co any of the documents referred to in Section 2 of Schedule 2 – Completion Documents by the Financial Close Target Date (other than as a direct result of a breach by Project Co of its obligations under Section 2.3(b)(i)) and Project Co does not waive such requirement, Project Co will be entitled to the return of the Standby Letter of Credit and to terminate this Project Agreement in its entirety by written Notice having immediate effect.

2.4 Disruption in Financial Markets

- (a) If Financial Close cannot be achieved by the Financial Close Target Date by reason solely of a Severe Market Disruption, subject to Project Co's obligation to renew the Standby Letter of Credit pursuant to Section 2.2, the Financial Close Target Date will be extended until the date falling 10 Business Days (or such other period as the Parties agree, acting reasonably) after the date on which such Severe Market Disruption ceases.
- (b) If a Severe Market Disruption exists, then, at any time before such Severe Market Disruption ceases and prior to Financial Close, Contracting Authority may in its sole discretion either:
- (i) terminate this Project Agreement in its entirety by written Notice having immediate effect; or
 - (ii) direct Project Co to assign to a designee of Contracting Authority which has agreed to assume:
 - (A) the Project Agreement, and all of Project Co's right, title and interest in the Project Data, the Intellectual Property Rights and the Project Co Permits, Licences, Approvals and Agreements; and
 - (B) those contracts between Project Co and any Project Co Party which Contracting Authority elects to be assigned.
- (c) If Contracting Authority exercises its rights pursuant to Section 2.4(b), and, provided Project Co has, if directed, delivered the assignments provided for in Section 2.4(b)(ii)(A) and (B) above, Project Co will be entitled to the return of its Standby Letter of Credit and to payment of an amount equal to the Design and Bid Fee pursuant to Section 10.3.2 of the Request for Proposals plus **[REDACTED]**% of such fee. Contracting Authority's obligation to return the Standby Letter of Credit and to pay such fee shall be contingent on the receipt of a waiver, in form and substance satisfactory to Contracting Authority, that such fee represents full and final satisfaction of any obligation or liability of Contracting Authority and any other Government Entity to Project Co

and any Project Co Parties in connection with the Project Agreement and the Request for Proposals process.

3. GUARANTEED PRICE

3.1 Guaranteed Price and Adjustments

- (a) Project Co represents and warrants that the Guaranteed Price, exclusive of HST, is \$[REDACTED], and is equal to the sum of the Cost of the Works and the Cost of the Financing. The Cost of the Works and the Cost of the Financing are as set out in the Financial Model.
- (b) Project Co represents and warrants that the Project Debt Interest Cost is based upon the Interest Reference Rate. The Project Debt Interest Cost will be adjusted once on, or within the two Business Days immediately prior to, Financial Close on the basis of the actual increase or decrease in the Project Debt Interest Cost resulting directly from any change upward or downward in the Interest Reference Rate as compared to the Interest Reference Rate as at the RFP Submission Deadline.
- (c) The Parties:
 - (i) acknowledge that the Project Debt Interest Cost is a component of the Cost of the Financing and that the Project Debt Interest Cost is subject to adjustment under Section 3.1(b) as at the date set out in Section 3.1(b); and
 - (ii) acknowledge and agree that subject to adjustments made in accordance with the provisions of this Project Agreement, the final Guaranteed Price shall be determined on the basis of such final adjusted Cost of the Financing and the final adjusted Cost of the Works as of the date set out in Section 3.1(b).
- (d) Subject to the provisions of Section 3.1(c), the Parties agree that the Guaranteed Price will not be subject to adjustment despite changes in the Works, unless such changes in the Works arise pursuant to a Variation Confirmation. The Parties further agree that the Guaranteed Price will only be adjusted where the Project Agreement specifically and expressly refers to an adjustment to the Guaranteed Price, and no claim for an adjustment to the Guaranteed Price on any legal or equitable basis outside of the specific and express rights to an adjustment of the Guaranteed Price set out in the Project Agreement will be allowed. In order to be effective, any permitted adjustment to the Guaranteed Price must be provided for in a Variation Confirmation under Schedule 22 – Variation Procedure.
- (e) Project Co acknowledges and agrees that,
 - (i) Project Co has satisfied itself as to the correctness and sufficiency of the Guaranteed Price, and has based the Guaranteed Price on the data, interpretations, necessary information, examinations and satisfaction as to all relevant matters and any further data relevant to the design;
 - (ii) the Guaranteed Price covers all of Project Co's obligations under the Project Agreement, and all things necessary for the proper design, execution and completion of the Works, and the remedying of any defects; and

- (iii) the Guaranteed Price includes all premium time and overtime that may be required to perform the Works in accordance with this Project Agreement and Good Industry Practice.

3.2 [Not Used]

4. PAYMENT

4.1 General

- (a) Subject to the provisions of the Project Agreement (including, for clarity Section 3.1(d)) and in accordance with and subject to Applicable Law respecting holdbacks, Contracting Authority shall make the payments set out in this Section 4.
- (b) For the purpose of this Project Agreement, payments made by electronic transfer shall be deemed to have been made on the day and at the time the electronic transfer is initiated, as confirmed by the initiating bank by a confirmation setting out the transfer number and the other details of the transfer.

4.2 Acknowledgement by Project Co

- (a) Project Co acknowledges and agrees with Contracting Authority that Contracting Authority is not responsible for the payment of any base progress payments pursuant to the Design and Construction Contract nor any legislative holdbacks in respect thereof.

4.3 Lump Sum Payments

- (a) Subject to Sections 4.4(a) and 4.8, Contracting Authority covenants and agrees to pay to Project Co the First Milestone Payment and the applicable HST on the applicable Milestone Payment Date.
- (b) Subject to Sections 4.4(a) and 4.8, Contracting Authority covenants and agrees to pay to Project Co the Second Milestone Payment and the applicable HST on the applicable Milestone Payment Date.
- (c) Subject to Sections 4.4(b) and 4.8, Contracting Authority covenants and agrees to pay to Project Co the Substantial Completion Payment and the applicable HST, plus any Major Track Closure Adjustment on the Substantial Completion Payment Date.

4.4 Directions of Payments

- (a) Project Co hereby irrevocably directs Contracting Authority to make any Milestone Payment, together with applicable HST, to the Lenders' Agent or as the Lenders' Agent may direct in accordance with this Section 4.4(a). Contracting Authority shall pay the First Milestone Payment and the Second Milestone Payment, as applicable, as directed by Project Co in accordance with this Section 4.4(a) and shall not accept any redirection without the consent of the Lenders' Agent. Contracting Authority will pay the amounts that Project Co is entitled to hereunder once the conditions for payment set out in this Project Agreement, if any, have been satisfied. Project Co acknowledges and agrees that payment by Contracting Authority of the First Milestone Payment

and the Second Milestone Payment, as applicable, to the Lenders' Agent in accordance with this Section 4.4(a) constitutes payment by Contracting Authority to Project Co in satisfaction of Contracting Authority's obligation to pay the First Milestone Payment and the Second Milestone Payment, as applicable, to Project Co under this Project Agreement and in satisfaction of any trust obligation of Contracting Authority with respect to such payments under section 7 of the Construction Act pursuant to section 10 of the Construction Act.

- (b) Project Co hereby irrevocably directs Contracting Authority to make any Substantial Completion Payment, together with applicable HST, to the Lenders' Agent or as the Lenders' Agent may direct. Contracting Authority shall pay the Substantial Completion Payment as directed by Project Co in accordance with this Section 4.4(b) and shall not accept any redirection without the consent of the Lenders' Agent. Contracting Authority will pay the amounts that Project Co is entitled to hereunder once the conditions for payment set out in this Project Agreement, if any, have been satisfied. Project Co acknowledges and agrees that payment by Contracting Authority of the Substantial Completion Payment to the Lenders' Agent in accordance with this Section 4.4(b) constitutes payment by Contracting Authority to Project Co in satisfaction of Contracting Authority's obligation to pay the Substantial Completion Payment to Project Co under this Project Agreement and in satisfaction of any trust obligation of Contracting Authority with respect to such payments under section 7 of the Construction Act pursuant to section 10 of the Construction Act.

4.5 Payment of Legislative Holdback

- (a) Subject to Section 4.8, Contracting Authority covenants and agrees with Project Co to pay to Project Co the Legislative Holdback on the Legislative Holdback Payment Date or pay to such party as otherwise directed by Project Co and shall not accept any redirection without the consent of the person to whom payment is directed. Contracting Authority agrees to pay the Legislative Holdback as Project Co may direct in accordance with any such direction. Project Co acknowledges and agrees that payment by Contracting Authority of the Legislative Holdback in accordance with this Section 4.5 as Project Co may direct, constitutes payment by Contracting Authority to Project Co in satisfaction of Contracting Authority's obligation to pay the Legislative Holdback to Project Co under this Project Agreement and in satisfaction of any trust obligation of Contracting Authority with respect to such payments under section 7 of the Construction Act pursuant to section 10 of the Construction Act.
- (b) After the issuance of the Substantial Completion Certificate under Section 25.4, Project Co shall:
 - (i) submit an application for payment of the Legislative Holdback amount;
 - (ii) submit a written request for release of the Legislative Holdback, including a declaration that no written notice of lien arising in relation to the performance of the Works has been received by it that has not been withdrawn by the lien claimant;
 - (iii) submit a Statutory Declaration CCDC Form 9A (2001); and
 - (iv) submit an original WSIB Certificate of Clearance.
- (c) After the later of (i) the receipt of the documents set out in Section 4.5(b), and (ii) the expiration of a period of 45 days from the date of publication of the certificate of substantial performance

pursuant to the Construction Act, the Independent Certifier shall issue a certificate for payment of the Legislative Holdback.

- (d) Prior to the date of the release of the Legislative Holdback, Project Co shall have removed from the Lands, the New Metrolinx Infrastructure, the New Third Party Infrastructure and the Existing Infrastructure all supplies, waste materials, rubbish and temporary facilities and all personnel except as required to achieve Final Completion or to correct any remaining Minor Deficiencies.
- (e) Subject to the provisions of Section 17.3 and the removal of claims for lien preserved or perfected pursuant to the Construction Act arising in relation to the performance of the Works, the Legislative Holdback amount authorized by the certificate for payment of the Legislative Holdback amount is due and payable on the second Business Day following the receipt of the certificate for payment of the Legislative Holdback amount pursuant to Section 4.5(c).

4.6 Payment of Finishing Holdback

- (a) Subject to Section 4.8, Contracting Authority covenants and agrees with Project Co to pay to Project Co the Finishing Holdback on the Finishing Holdback Payment Date or pay to such party as otherwise directed by Project Co and shall not accept any redirection without the consent of the person to whom payment is directed. Contracting Authority agrees to pay the Finishing Holdback as Project Co may direct in accordance with any such direction. Project Co acknowledges and agrees that payment by Contracting Authority of the Finishing Holdback in accordance with this Section 4.6(a) as Project Co may direct, constitutes payment by Contracting Authority to Project Co in satisfaction of Contracting Authority's obligation to pay the Finishing Holdback to Project Co under this Project Agreement and in satisfaction of any trust obligation of Contracting Authority with respect to such payment under section 7 of the Construction Act pursuant to section 10 of the Construction Act.
- (b) Upon the date Project Co considers that the Finishing Holdback in respect of an applicable component of the Works may be released, Project Co shall:
 - (i) submit an application for the payment of the Finishing Holdback amount;
 - (ii) submit a written request for the Finishing Holdback, including a declaration that no written notices of lien arising from the performance of the Works have been received by it;
 - (iii) submit a Statutory Declaration CCDC Form 9A (2001); and
 - (iv) submit an original WSIB Certificate of Clearance.
- (c) After the later of,
 - (i) the receipt of the documents set out in Section 4.6(b); and
 - (ii) the date that all liens that may have been claimed against the Finishing Holdback in respect of the applicable component of the Works have expired as provided in Part V of the

Construction Act or have been satisfied, discharged or provided for under section 44 of the Construction Act,

the Independent Certifier shall issue a certificate for payment of the Finishing Holdback.

- (d) Subject to the provisions of Section 17.3 and the removal of claims for lien preserved or perfected pursuant to the Construction Act arising in relation to the performance of the Works, the Finishing Holdback amount authorized by the certificate for payment of the Finishing Holdback amount pursuant to Section 4.6(c) is due and payable by Contracting Authority on the second Business Day following the receipt of such certificate for payment.

4.7 Completion Holdback and Seasonal Works Holdback

- (a) Intentionally Deleted.
- (b) The Completion Holdback may be reduced from time to time as a result of such actions by Project Co, as confirmed by the Independent Certifier, in accordance with the terms and conditions of this Project Agreement. To the extent the Completion Holdback is reduced from time to time, Project Co hereby irrevocably directs Contracting Authority to pay the amount of any Completion Holdback reduction, together with applicable HST, to the Lenders' Agent or as the Lenders' Agent may direct, as security for the Financing. Contracting Authority agrees to pay the Completion Holdback reductions as directed by Project Co and shall not accept any redirection without the consent of the Lenders' Agent. Project Co acknowledges and agrees that payment by Contracting Authority of the Completion Holdback reductions in accordance with this Section 4.7(b) as Project Co may direct constitutes payment by Contracting Authority to Project Co in satisfaction of Contracting Authority's obligation to pay the Completion Holdback reductions to Project Co under this Project Agreement and in satisfaction of any trust obligation of Contracting Authority with respect to such payments under Section 7 of the Construction Act pursuant to Section 10 of the Construction Act.
- (c) The Seasonal Works Holdback may be reduced from time to time as a result of such actions by Project Co, as confirmed by the Independent Certifier, in accordance with the terms and conditions of this Project Agreement. To the extent the Seasonal Works Holdback is reduced from time to time, Project Co hereby irrevocably directs Contracting Authority to pay the amount of any Seasonal Works Holdback reduction, together with applicable HST, to the Lenders' Agent or as the Lenders' Agent may direct, as security for the Financing. Contracting Authority agrees to pay the Seasonal Works Holdback reductions as directed by Project Co and shall not accept any redirection without the consent of the Lenders' Agent. Project Co acknowledges and agrees that payment by Contracting Authority of the Seasonal Works Holdback reductions in accordance with this Section 4.7(c) as Project Co may direct constitutes payment by Contracting Authority to Project Co in satisfaction of Contracting Authority's obligation to pay the Seasonal Works Holdback reductions to Project Co under this Project Agreement and in satisfaction of any trust obligation of Contracting Authority with respect to such payments under Section 7 of the Construction Act pursuant to Section 10 of the Construction Act.

4.8 Compensation on Termination

- (a) If this Project Agreement is terminated pursuant to Sections 36.3(a), 37.2(a)(ii), 38.1, 38.2 or 38.3, then:
- (i) Schedule 23 – Compensation on Termination shall apply and Contracting Authority shall pay Project Co any applicable compensation on termination; and
 - (ii) the provisions of Sections 4.3 through 4.7, inclusive, shall no longer apply.
- (b) Project Co hereby irrevocably directs Contracting Authority to make any Compensation Payment to the Lenders' Agent, or as the Lenders' Agent may direct. Contracting Authority shall pay the Compensation Payment as directed by the Lenders' Agent and shall not accept any redirection without the consent of Lenders' Agent. Contracting Authority will pay the Compensation Payment in accordance with the provisions of Schedule 23 – Compensation on Termination. Project Co acknowledges and agrees that payment by Contracting Authority of the Compensation Payment to the Lenders' Agent in accordance with this Section 4.8 constitutes payment by Contracting Authority to Project Co in satisfaction of Contracting Authority's obligation to pay the Compensation Payment to Project Co under this Project Agreement and in satisfaction of any trust obligation of Contracting Authority with respect to such payments under section 7 of the Construction Act pursuant to section 10 of the Construction Act.

4.9 Payment Due under Insurance Policies

- (a) In the event of loss or damage occurring where payment becomes due under the property and boiler insurance policies, payments shall be made in accordance with the provisions of the Insurance Trust Agreement.

4.10 HST

- (a) Contracting Authority covenants and agrees to pay to Project Co the HST that may be exigible with respect to any payments made by Contracting Authority to Project Co hereunder.

4.11 Set-Off

- (a) The Parties agree that their rights of set-off at law or in equity are limited to the right of:
- (i) Contracting Authority, to set off against any amounts otherwise due to Project Co pursuant to the terms of this Project Agreement (other than any Milestone Payments), any amounts (including any amounts payable in accordance with Section 46, or any amounts payable as liquidated damages pursuant to Schedule 21 – Liquidated Damages and Construction Enforcement Regime) that,
 - (A) are due or owed to Contracting Authority from or by Project Co pursuant to the terms of this Project Agreement or by the Construction Guarantor pursuant to Schedule 29 – Form of Performance Guarantee of Construction Guarantor; or
 - (B) are being disputed in accordance with Schedule 27 – Dispute Resolution Procedure; and

- (ii) Project Co to set off against any amounts otherwise due to Contracting Authority pursuant to the terms of this Project Agreement, any amounts (including any amounts payable in accordance with Section 46) that,
 - (A) are due or owed to Project Co from or by Contracting Authority pursuant to the terms of this Project Agreement; or
 - (B) are being disputed in accordance with Schedule 27 – Dispute Resolution Procedure.
- (b) For clarity, Contracting Authority is entitled to exercise its rights in accordance with Section 4.11(a)(i) immediately upon an amount becoming due or owed to Contracting Authority,
 - (i) by Project Co pursuant to the terms of this Project Agreement; or
 - (ii) by the Construction Guarantor pursuant to Schedule 29 – Form of Performance Guarantee of Construction Guarantor.

4.12 Effect of Payment

- (a) Subject to Section 40.2, no payment hereunder shall be construed as an acceptance or approval of incomplete, defective or improper performance by Project Co of any of its obligations under this Project Agreement, nor shall it operate to relieve Project Co from the performance of any of its obligations under this Project Agreement which have not been performed.

4.13 No Other Entitlement

- (a) Project Co shall not be entitled to any payments, compensation, rights, remedies, benefits or entitlements under or in connection with this Project Agreement, except as specifically and expressly set out in this Project Agreement.

4.14 Taxes

- (a) All amounts specified in this Project Agreement, including, for clarity, any compensation payable on termination, are expressed exclusive of HST, but inclusive of all other Taxes payable pursuant to Applicable Law. For clarity, Contracting Authority shall not be required to pay any interest and/or penalties that are imposed on or assessed against Project Co or any Project Co Party for non-compliance with Applicable Law. If Project Co is required by Applicable Law to collect any such HST from Contracting Authority, Contracting Authority shall pay such HST to Project Co simultaneously with the amount to which such applicable HST relates or applies.
- (b) Contracting Authority shall pay when due and payable, all property taxes or payments in lieu of property taxes that are assessed in respect of ownership or use of the Metrolinx Lands, the New Metrolinx Infrastructure, the Existing Infrastructure and the New Third Party Infrastructure.
- (c) Contracting Authority shall pay all applicable HST properly payable in accordance with the *Excise Tax Act* (Canada) by Contracting Authority upon and in connection with payments by Contracting Authority to Project Co under this Project Agreement.

4.15 Changes in Scope of Taxation

- (a) If, as a result of a Change in Law, the application of Taxes under Part IX of the *Excise Tax Act* (Canada) or any provincial sales tax legislation changes with respect to the provision of any goods or services by Project Co in connection with the performance of the Works, Contracting Authority and Project Co agree to co-operate to determine how such change affects their respective obligations under this Project Agreement to the extent not already addressed in this Project Agreement.

4.16 Changes in Recoverability of Tax Credits

- (a) Contracting Authority will pay to Project Co from time to time, as the same is incurred by Project Co, amounts equal to any Irrecoverable Tax to the extent such Irrecoverable Tax results from a Change in Law. Project Co will pay to Contracting Authority from time to time, as the same is incurred by Project Co, amounts equal to any Recoverable Tax to the extent such Recoverable Tax results from a Change in Law.
- (b) For the purposes of this Section 4.16, the term “**Irrecoverable Tax**” means HST or an irrecoverable sales tax levied by the Province in lieu of all or a portion of HST incurred by Project Co in respect of the supply of any good or service to Contracting Authority which is consumed, used or supplied, or to be consumed, used or supplied, exclusively by Project Co in the course of carrying out the Works to the extent that Project Co is unable to recover or be credited with input tax credits, refunds, rebates or exemptions for such HST.
- (c) For the purposes of this Section 4.16, the term “**Recoverable Tax**” means HST incurred by Project Co in respect of the supply of any good or service to Contracting Authority which is consumed, used or supplied, or to be consumed, used or supplied, exclusively by Project Co in the course of carrying out the Works to the extent that Project Co is able to recover or be credited with input tax credits, refunds, rebates or exemptions for such HST.

4.17 Information and Assistance Provided by Project Co

- (a) Project Co shall, at Contracting Authority’s request and cost, assist Contracting Authority in applying for and obtaining all remissions and credits of Taxes to which Contracting Authority is entitled.
- (b) Contracting Authority may apply for a global or general exemption, waiver, remission, or refund of some or all Taxes which may otherwise be applicable in relation to this Project Agreement. Project Co shall, at Contracting Authority’s cost, assist Contracting Authority in making any applications for such global or general exemption, waiver, remission or refund and shall provide Contracting Authority with such documentation as Contracting Authority may reasonably require to support such application and, in any event, shall provide such consent as Contracting Authority may require. Any exemption, waiver, remission, refund or other recovery of Taxes obtained by Contracting Authority through such application shall accrue to the sole benefit of Contracting Authority.
- (c) Project Co will provide Contracting Authority with any information reasonably requested by Contracting Authority from time to time in relation to any Taxes chargeable in accordance with this Project Agreement and payable by Contracting Authority to Project Co from time to time.

4.18 Residency – Income Tax Act (Canada)

- (a) Project Co shall not undertake any action or transaction that, if undertaken, would cause or result in Project Co becoming a Non-Resident without Contracting Authority’s prior written consent, which consent may be withheld in Contracting Authority’s sole discretion.

4.19 Taxes – General

- (a) Project Co shall not, without the prior written consent of Contracting Authority (which consent may be withheld in its sole discretion), undertake any action or transaction that, if undertaken, would cause Contracting Authority to have (or result in Contracting Authority having) any obligation to deduct, withhold or remit any Taxes that are required by Applicable Law to be deducted, withheld or remitted from any amounts paid or credited to Project Co or any Project Co Party under this Project Agreement or under any other Ancillary Document.

4.20 Taxes – Indemnity

- (a) If (i) Project Co becomes a Non-Resident, or (ii) Contracting Authority is or becomes required by Applicable Law to deduct or withhold any amount in respect of Taxes on or in respect of any amounts paid or credited to Project Co or a Project Co Party by Contracting Authority under the Project Agreement or under any of the Project Documents, then Contracting Authority shall be entitled to make any applicable deductions or withholdings required by Applicable Law from any amount paid or credited or to be paid or credited to Project Co or a Project Co Party on or after the date on which (A) Project Co or the Project Co Party becomes a Non-Resident and at all times while it remains a Non-Resident; or (B) Contracting Authority is required by Applicable Law to deduct or withhold amounts in respect of any such amounts, in each case, in respect of all Taxes that are required by Applicable Law to be deducted or withheld from amounts paid or credited to a Non-Resident or otherwise as required by Applicable Law; and all amounts paid or credited by Contracting Authority under this Project Agreement or under any other Ancillary Document to Project Co or a Project Co Party shall be paid or credited net of such deductions or withholdings.
- (b) If (i) Project Co becomes a Non-Resident, or (ii) Contracting Authority is or becomes required by Applicable Law to deduct and withhold any amount in respect of Taxes on or in respect of any amounts paid or credited to Project Co or a Project Co Party by Contracting Authority under the Project Agreement or under any of the Project Documents, Project Co shall, in each case, indemnify and hold harmless Contracting Authority for (A) the full amount of all Taxes (“**Indemnifiable Taxes**”) that arise, are imposed on or are required to be paid by Contracting Authority in respect of any amounts paid or credited by Contracting Authority to Project Co or any Project Co Party under this Project Agreement or under any other Ancillary Document as a result of either of the foregoing items less any amount withheld or deducted by Contracting Authority in respect of such Taxes, and (B) any liability payable or incurred in connection with Indemnifiable Taxes (including penalties, interest and reasonable expenses associated with Tax compliance, reporting and contesting such liability for Indemnifiable Taxes, including reasonable professional expenses payable or incurred in connection therewith) arising from or with respect to Indemnifiable Taxes, whether or not they were correctly or legally asserted (“**Associated Liabilities**”). Payment under this indemnification shall be made within 30 days after the date Contracting Authority makes written demand for it. A certificate containing reasonable detail as to the amount of Indemnifiable Taxes and Associated Liabilities submitted to Project Co by Contracting Authority shall be conclusive evidence, absent manifest error, of the amount due from

Project Co to Contracting Authority. Contracting Authority shall be entitled to exercise its rights of set off under Section 4.11 against any amounts owing under this indemnification.

4.21 Cost Adjustment – Utilities

- (a) Prior to Substantial Completion, Project Co shall provide its estimate of the cost adjustment that is to be applied to the Substantial Completion Payment. The “**Cost Adjustment – Utilities**” means an amount calculated in accordance with the following:
- (i) If the Changed Cost for Utilities is less than the Original Eligible Utilities Costs (and the Changed Cost for Utilities is a positive number) the Substantial Completion Payment shall be increased by 50 per cent of the Changed Cost for Utilities;
 - (ii) If the Changed Cost for Utilities is a negative number, the Substantial Completion Payment will be decreased by 50 per cent of the Changed Cost for Utilities; and
 - (iii) If Changed Cost for Utilities is greater than the Original Eligible Utilities Costs, the Substantial Completion Payment shall be increased by,
 - (A) 50 per cent of the Changed Cost for Utilities up to the point at which the Changed Cost for Utilities equals the Original Eligible Utilities Cost; plus
 - (B) 100 per cent of that portion of the Changed Cost for Utilities that exceeds the value of Original Eligible Utilities Cost.
- (b) Project Co shall keep detailed records of all amounts invoiced to Project Co by the Category 1 Utility Companies of sufficient detail to enable Project Co to demonstrate that a Changed Cost for Utilities has arisen. Contracting Authority may, in its sole discretion, withhold any payment due to Project Co in accordance with Section 4.21(a) if Project Co fails to keep such records.
- (c) As part of Project Co’s Works Report, Project Co shall provide detailed monthly reports to the Contracting Authority Representative, each of which shall include the following information itemized for each Category 1 Utility Company:
- (i) itemized and aggregate Eligible Utilities Costs committed to date for each Category 1 Utility Company and the aggregate of such Eligible Utilities Costs for all Category 1 Utility Companies (including copies of all vendor invoices provided up to and including the date of the monthly report which have not previously been provided to Contracting Authority);
 - (ii) itemized and aggregate Eligible Utilities Costs spent to date for all Category 1 Utility Companies and the aggregate of such spent Eligible Utilities Costs for all Category 1 Utility Companies; and
 - (iii) the projected Eligible Utilities Costs for each Category 1 Utility Company and the aggregate of such projected Eligible Utilities Costs for all Category 1 Utility Companies.
- (d) If Contracting Authority requires additional information or detail for the purposes of calculating the Cost Adjustment - Utilities, Project Co shall promptly provide to Contracting Authority such

information or detail at Contracting Authority's request. Contracting Authority shall consider the monthly reports and the information provided by Project Co in accordance with Section 4.21(c) and this Section 4.21(d) for the purposes of Contracting Authority's calculation and determination of the Cost Adjustment - Utilities in accordance with Section 4.21(a).

- (e) Any Dispute between Contracting Authority and Project Co as to the Cost Adjustment - Utilities will be referred for determination to the Dispute Resolution Procedure.
- (f) Project Co shall provide Contracting Authority with copies of all correspondence and documentation received or sent by Project Co from or to Category 1 Utility Companies forthwith following the receipt or sending thereof.

5. SCOPE OF AGREEMENT

5.1 Scope of Agreement

- (a) Project Co shall undertake the Project and perform the Works in accordance with and subject to the provisions of this Project Agreement.
- (b) Project Co shall exercise its rights and perform its obligations at its own cost and risk without recourse to Contracting Authority, except as otherwise provided in this Project Agreement.

6. REPRESENTATIONS AND WARRANTIES

6.1 Project Co Representations and Warranties

- (a) Project Co represents and warrants to Contracting Authority that as of Commercial Close:
 - (i) Project Co [REDACTED] has all the requisite power and authority to own its properties and assets, to carry on its business as it is currently being conducted, and to enter into this Project Agreement and to perform its obligations hereunder.
 - (ii) GCP Davenport Inc. is a corporation incorporated and validly existing under the laws of the Province of Ontario, is in good standing with Ministry of Government and Consumer Services of Ontario with respect to the filing of annual reports and has all the requisite corporate power and authority to own its properties and assets, to carry on its business as it is currently being conducted and to enter into this Agreement and to perform its obligations hereunder in its capacity as a partner of Project Co;
 - (iii) Gracorp Davenport Inc. is a corporation incorporated and validly existing under the laws of the Province of Ontario, is in good standing with Ministry of Government and Consumer Services of Ontario with respect to the filing of annual reports and has all the requisite corporate power and authority to own its properties and assets, to carry on its business as it is currently being conducted and to enter into this Agreement and to perform its obligations hereunder in its capacity as a partner of Project Co;
 - (iv) Project Co and the Project Co Parties, collectively, have extensive experience and are knowledgeable in the design and construction of infrastructure and facilities similar to those included in the scope of the Project in scale, scope, type and complexity, and have

- the required ability, experience, skill and capacity to perform the Works in a timely and professional manner as set out in this Project Agreement;
- (v) Project Co has the requisite power, authority and capacity to execute and deliver and perform this Project Agreement, and to do all acts and things, and execute, deliver and perform all other agreements, instruments, undertakings and documents as are required by this Project Agreement to be done, executed, delivered or performed;
 - (vi) no steps or proceedings have been taken or are pending to supersede or amend the constating documents, articles or by-laws of Project Co in a manner that would impair or limit its ability to perform the obligations of Project Co under this Project Agreement;
 - (vii) this Project Agreement has been duly authorized, executed, and delivered by Project Co and constitutes a legal, valid, and binding obligation of Project Co, enforceable against Project Co in accordance with its terms, subject only to:
 - (A) limitations with respect to the enforcement of remedies by bankruptcy, insolvency, moratorium, winding-up, arrangement, reorganization, fraudulent preference and conveyance and other laws of general application affecting the enforcement of creditors' rights generally; and
 - (B) general equitable principles and the fact that the availability of equitable remedies is in the discretion of a court and that a court may stay proceedings or the execution of judgments;
 - (viii) the execution, delivery, and performance by Project Co of this Project Agreement does not and will not violate or conflict with, or constitute a default under:
 - (A) its constating, formation or organizational documents, including any by-laws;
 - (B) any Applicable Law; or
 - (C) any covenant, contract, agreement, or understanding to which it is a party or by which it or any of its properties or assets is bound or affected;
 - (ix) no Project Co Event of Default has occurred and is continuing;
 - (x) all of the information regarding Project Co set out in Schedule 31 – Project Co Information is true and correct in all material respects;
 - (xi) there are no actions, suits, proceedings, or investigations pending or threatened against Project Co or, to Project Co's knowledge, any Project Co Party at law or in equity before any Governmental Authority or arbitral body (whether or not covered by insurance) that individually or in the aggregate could result in any material adverse effect on the business, properties, or assets, or the condition, financial or otherwise, of Project Co or in any impairment of its ability to perform its obligations under this Project Agreement, and Project Co has no knowledge of any violation or default with respect to any order, writ, injunction, or decree of any Governmental Authority or arbitral body that could result in any such material adverse effect or impairment;

- (xii) Project Co has conducted its own investigations and has carefully reviewed the whole of this Project Agreement, and all other documents made available to Project Co by or on behalf of Contracting Authority, and, to Project Co's knowledge, nothing contained herein or therein inhibits or prevents Project Co from completing the Works or performing the Works in accordance with this Project Agreement in a good and safe manner so as to achieve and satisfy the requirements of this Project Agreement;
- (xiii) Project Co is able to meet its obligations as they generally become due;
- (xiv) Project Co is registered under Division V of Part IX of the *Excise Tax Act* (Canada) and its HST registration number is [REDACTED];
- (xv) the Scheduled Interim Completion Date and the Scheduled Substantial Completion Date are realistic dates and are achievable by Project Co performing the Works in accordance with this Project Agreement;
- (xvi) Project Co is not a Non-Resident;
- (xvii) Project Co has obtained all necessary Project Co Permits, Licences, Approvals and Agreements required to commence the Works;
- (xviii) the management or supervisory personnel Project Co has assigned to the Project are highly experienced;
- (xix) Project Co has a sufficient staff of qualified and competent personnel to replace its designated supervisors, subject to Contracting Authority's approval, in the event of death, incapacity or resignation;
- (xx) Project Co and certain of the Project Co Parties have conducted inspections of the Lands prior to Commercial Close and an investigation and examination of the Project Agreement, the Background Information and any other documents made available to Project Co by Contracting Authority so as to ascertain the nature or location of the Works and the Lands, the physical conditions of the Lands and the Existing Infrastructure, and protocols, rules and regulations if any, possible delays in commencing the Works, conditions relating to the transportation, handling and storage of materials and availability of labour and the character and availability of equipment, materials and facilities needed to perform the Works;
- (xxi) Project Co has secured the Financing and is in a position to complete the Financing on or before the Financial Close Target Date, subject to the satisfaction of reasonable conditions that are customary in closing financing for projects similar to the Project;
- (xxii) no Restricted Person has Direct or Indirect Power or Control over any member of the Project Co Group in relation to the decisions, management, actions or policies of Project Co or in relation to the operation, management and ownership of the Project;
- (xxiii) to the knowledge of Project Co, no Restricted Person has directly or indirectly, an Economic Interest in Project Co or the Project; and

(xxiv) either:

- (A) the COR-Certified Construction Project Co Party is in possession of its COR Certification in good standing as required under this Project Agreement and has the ability to maintain such COR Certification in good standing at all times during the performance of the Works in accordance with its terms, provisions and conditions; or
- (B) the COR-Qualified Construction Project Co Party:
 - (I) is in possession of its OHSAS 18001 Accreditation which remains in good standing and has the ability to maintain such OHSAS 18001 Accreditation in good standing at all times during the performance of the Works until such COR-Qualified Construction Project Co Party receives its COR Certification as required under this Project Agreement, and
 - (II) has made an application to the IHSA for its COR Certification as required under this Project Agreement.

6.2 Contracting Authority Representations and Warranties

- (a) IO represents and warrants to Project Co, on a several basis, that as of Commercial Close:
 - (i) IO is a non-share capital corporation amalgamated and continued under the *Ontario Infrastructure and Lands Corporation Act, 2011*, S.O. 2011, c. 9, Schedule 32, as amended, which provides all the requisite corporate power and authority for IO to own its properties and assets, to carry on its business as it is currently being conducted, and to enter into this Project Agreement as agent for the Province;
 - (ii) subject to Sections 6.2(a)(v)(C), (D), (E) and (F), as applicable, IO is entering into this Project Agreement as agent for the Province and has the requisite power, authority and capacity to execute and deliver this Project Agreement and to bind the Province to this Project Agreement, and Project Co is entitled to rely upon IO's authority to bind the Province in respect of all other agreements, instruments, undertakings and documents executed and delivered by IO as agent for the Province that are required by this Project Agreement to be executed and delivered by IO;
 - (iii) subject to Sections 6.2(a)(v)(C), (D), (E) and (F), IO has the requisite power, authority and capacity to perform its obligations under this Project Agreement and to do all acts and things, and execute, deliver and perform all other agreements, instruments, undertakings and documents as are required by this Project Agreement to be done, executed, delivered or performed;
 - (iv) subject to Sections 6.2(a)(v)(C), (D) and (E), IO has obtained all of the necessary approvals to enter into and perform its obligations under this Project Agreement;
 - (v) this Project Agreement has been duly authorized, executed, and delivered by IO and constitutes a legal, valid, and binding obligation of IO, enforceable against IO in accordance with its terms, subject only to:

- (A) limitations with respect to the enforcement of remedies by bankruptcy, insolvency, moratorium, winding-up, arrangement, reorganization, fraudulent preference and conveyance and other laws of general application affecting the enforcement of creditors' rights generally;
 - (B) general equitable principles and the fact that the availability of equitable remedies such as specific performance and injunction are not available against the Province and that a court may stay proceedings or the execution of judgments;
 - (C) statutory limitations of general application respecting the enforceability of claims against the Province or its property;
 - (D) section 11.3 of the *Financial Administration Act* (Ontario);
 - (E) any terms and conditions set out in the approval that has been provided in connection with this Project Agreement for the purposes of section 28 of the *Financial Administration Act* (Ontario); and
 - (F) the powers of the Minister of Finance to effect set offs against amounts owing by Ontario pursuant to section 43 of the *Financial Administration Act* (Ontario); and
- (vi) the execution, delivery, and performance by IO of this Project Agreement does not and will not violate or conflict with, or constitute a default under:
- (A) the *Ontario Infrastructure and Lands Corporation Act, 2011*, S.O. 2011, c. 9, Schedule 32, as amended, or any regulations made in respect thereof;
 - (B) the *Executive Council Act*, R.S.O. 1990, c. E.25;
 - (C) any Applicable Law; or
 - (D) any covenant, contract, agreement, or understanding relating to the Project or the Lands to which it is a party or by which it or any of its properties or assets is bound or affected.
- (b) Metrolinx represents and warrants to Project Co, on a several basis, that as of Commercial Close:
- (i) Metrolinx is a non-share capital corporation continued under the *Metrolinx Act, 2006*, S.O. 2006, c. 16 and has all of the requisite corporate power and authority to own its properties and assets, to carry on its business as it is currently being conducted, and to enter into this Project Agreement in its own name as a Crown agency of the Province in accordance with Section 3 of the *Metrolinx Act, 2006*, S.O. 2006, c. 16;
 - (ii) subject to Sections 6.2(b)(v)(C), (D) and (E), Metrolinx is entering into this Project Agreement in its own name as a Crown agency of the Province and has the requisite power, authority and capacity to execute and deliver this Project Agreement and to bind itself personally to this Project Agreement and to provide recourse to the Province in accordance with the provisions of the *Metrolinx Act, 2006*, S.O. 2006, c. 16, including section 19 thereof, and Project Co is entitled to rely upon Metrolinx's authority to bind

itself and the recourse to the Province on such basis in respect of all other agreements, instruments, undertakings and documents executed and delivered by Metrolinx that are required by this Project Agreement to be executed and delivered by Metrolinx;

- (iii) subject to Sections 6.2(b)(v)(C), (D) and (E), Metrolinx has the requisite power, authority and capacity to perform its obligations under this Project Agreement and to do all acts and things, and execute, deliver and perform all other agreements, instruments, undertakings and documents as are required by this Project Agreement to be done, executed, delivered or performed;
- (iv) Metrolinx has obtained all necessary approvals to enter into this Project Agreement as a Crown agency;
- (v) this Project Agreement has been duly authorized, executed, and delivered by Metrolinx and constitutes a legal, valid, and binding obligation of Metrolinx, enforceable against Metrolinx, subject to the provisions of the *Metrolinx Act, 2006*, S.O. 2006, c. 16, in accordance with its terms, subject only to:
 - (A) limitations with respect to the enforcement of remedies by bankruptcy, insolvency, moratorium, winding-up, arrangement, reorganization, fraudulent preference and conveyance and other laws of general application affecting the enforcement of creditors' rights generally;
 - (B) general equitable principles and the fact that the availability of equitable remedies such as specific performance and injunction may not be available against Metrolinx and the Province and that a court may stay proceedings or the execution of judgments;
 - (C) statutory limitations of general application respecting the enforceability of claims against Metrolinx or the Province or the property of Metrolinx or the Province;
 - (D) any terms and conditions set out in the approval that has been provided in connection with this Project Agreement for the purposes of section 28 of the *Financial Administration Act*, R.S.O. 1990, c. F.12; and
 - (E) with regard to the recourse against the Province, section 35 of the *Metrolinx Act, 2006*, S.O. 2006, c. 16 and the powers of the Minister of Finance to effect set offs against amounts owing by the Province pursuant to section 43 of the *Financial Administration Act*, R.S.O. 1990, c. F.12;
- (vi) the execution, delivery, and performance by Metrolinx of this Project Agreement does not and will not violate or conflict with, or constitute a default under:
 - (A) the *Metrolinx Act, 2006*, S.O. 2006, c. 16, or any regulations made in respect thereof;
 - (B) any Applicable Law; or

- (C) any covenant, contract, agreement, or understanding relating to the Project or the Lands to which it is a party or by which it or any of its properties or assets is bound or affected; and
- (vii) Metrolinx has, or will have, licence rights of use and access to, on and over the Metrolinx Lands sufficient to enable Contracting Authority to grant or to cause to be granted to Project Co the access rights contemplated in Section 16.1.
- (c) Contracting Authority represents and warrants to Project Co, on a joint and several basis, that as of Commercial Close, no Contracting Authority Event of Default has occurred and is continuing.

7. BACKGROUND INFORMATION

7.1 No Liability

- (a) Except as expressly provided in Sections 7.4, 18.2, 18.3 and 18.4, none of Contracting Authority, any Province Person, or any Government Entity shall be liable to Project Co or any Project Co Party for, and Project Co or any Project Co Party shall not seek to recover from Contracting Authority, any Province Person, or any Government Entity, any damages, losses, costs, liabilities or expenses which may arise (whether in contract, tort or otherwise) from the adoption, use or application of the Background Information by, or on behalf of, Project Co or any Project Co Party.

7.2 No Warranty

- (a) Except as expressly provided in Sections 7.4, 18.2, 18.3 and 18.4:
 - (i) neither Contracting Authority nor any Province Person or Government Entity gives any warranty or undertaking of whatever nature in respect of the Background Information and, specifically (but without limitation), neither Contracting Authority nor any Province Person or Government Entity warrants that the Background Information represents all of the information in its possession or power (either during the conduct of the procurement process for the Project or at the time of execution and delivery of this Project Agreement) relevant or material to or in connection with the Project or the obligations of Project Co under this Project Agreement or under any of the Project Documents; and
 - (ii) neither Contracting Authority nor any Province Person or Government Entity shall be liable to Project Co or any Project Co Party in respect of any failure, whether before, on or after the execution and delivery of this Project Agreement:
 - (A) to disclose or make available to Project Co or any Project Co Party any information, documents or data;
 - (B) to review or update the Background Information; or
 - (C) to inform Project Co or any Project Co Party of any inaccuracy, error, omission, defect or inadequacy in the Background Information.

7.3 No Claims

- (a) Project Co acknowledges and confirms that:
- (i) it has conducted its own analysis and review of the Background Information and has, before the execution and delivery of this Project Agreement, satisfied itself as to the accuracy, completeness and fitness for purpose of any such Background Information upon which it places reliance; and
 - (ii) except as expressly provided in Sections 7.4, 18.2, 18.3 and 18.4, it shall not be entitled to and shall not, and shall ensure that no Project Co Party shall, make any claim against Contracting Authority, or any Province Person or Government Entity (whether in contract, tort or otherwise), including any claim in damages, for extensions of time or for additional payments under this Project Agreement on the grounds:
 - (A) of any misunderstanding or misapprehension in respect of the Background Information; or
 - (B) that the Background Information was incorrect or insufficient,
- nor shall Project Co be relieved from any of its obligations under this Project Agreement on any such ground.

7.4 Technical Reports

- (a) Contracting Authority agrees that, if at the date of this Project Agreement, except as disclosed in any Background Information or as otherwise disclosed by Contracting Authority or any Contracting Authority Party or known by Project Co or any Project Co Party, any of the information in the Technical Reports is, to the actual knowledge of Contracting Authority, incorrect or there is relevant information in the possession or control of Contracting Authority that would make any of the information in the Technical Reports incorrect, then, to the extent that such incorrect information materially adversely interferes with Project Co's ability to perform the Works or materially adversely affects Project Co's cost of performing the Works, such incorrect information shall, subject to and in accordance with Schedule 22 – Variation Procedure, result in a Variation.
- (b) For the purposes of Section 7.4(a), “to the actual knowledge of Contracting Authority” means to the actual knowledge of the IO Director – Civil Infrastructure or the Metrolinx Manager, Corridor Infrastructure – Barrie.

8. PROJECT DOCUMENTS

8.1 Project Documents

- (a) Project Co shall perform its obligations under, and observe all of the provisions of, each of the Project Documents to which it is a party, and shall ensure that each Project Co Party shall perform its obligations under, and observe all of the provisions of, each of the Project Documents to which such Project Co Party is a party, so as to ensure that other parties to such Project Documents shall not be entitled to terminate same.

- (b) In the event that Project Co receives a Notice of default under any of the Project Documents, it shall promptly, and, in any event, no later than two Business Days after receipt thereof, deliver a copy of such Notice of default to Contracting Authority.
- (c) Upon the written request of Contracting Authority or the Contracting Authority Representative, Project Co will deliver or cause to be delivered to Contracting Authority or the Contracting Authority Representative a copy of any notices or consents delivered or received by Project Co under any of the Project Documents.

8.2 Ancillary Documents

- (a) Project Co shall not:
 - (i) terminate or agree to the termination of all or part of any Ancillary Document, except pursuant to Sections 27.3, 49.3 and 50.2 or otherwise to prevent or cure a Project Co Event of Default (provided that commercially reasonable alternative measures would not prevent or cure such Project Co Event of Default);
 - (ii) make or agree to any amendment, restatement or other modification to any Ancillary Document that materially adversely affects Project Co's ability to perform its obligations under this Project Agreement or that has the effect of increasing any liability of Contracting Authority, whether actual or potential;
 - (iii) breach its obligations (or waive, exercise or allow to lapse any rights it may have) or permit others to breach their obligations (or waive, exercise or allow to lapse any rights they may have) under any Ancillary Document, if any such breach (or waiver, exercise or lapse) would materially adversely affect Project Co's ability to perform its obligations under this Project Agreement or that have the effect of increasing any liability of Contracting Authority, whether actual or potential; or
 - (iv) enter into, or permit the entry into by any other person of, any agreement replacing all or part of any Ancillary Document, except in the circumstances referenced in Section 8.2(a)(i),

without the prior written consent of Contracting Authority, provided that, where consent is requested pursuant to Section 8.2(a)(i) or 8.2(a)(iv), such consent shall not be withheld, and shall be provided within a reasonable time, where the relevant matter referred to in Section 8.2(a)(i) or 8.2(a)(iv) will not materially adversely affect Project Co's ability to perform its obligations under this Project Agreement or have the effect of increasing any liability of Contracting Authority, whether actual or potential. In the event of termination or agreement to the termination of all or part of any Ancillary Document as described in Section 8.2(a)(i), or the entering into of any agreement replacing all or part of any Ancillary Document as described in Section 8.2(a)(iv), Project Co shall, to the extent applicable, comply with all provisions herein relating to changes in Subcontractors, including Section 49.3.

8.3 Changes to Lending Agreements and Refinancing

- (a) Subject to the terms of the Lenders' Direct Agreement, Project Co shall not terminate, amend or otherwise modify the Lending Agreements, or waive or exercise any of its rights under the

Lending Agreements, if at the time such action is contemplated and effected, it would materially adversely affect Project Co's ability to perform its obligations under this Project Agreement or the Project Documents or have the effect of increasing the liability of Contracting Authority whether actual or potential, unless such action is a Permitted Borrowing or a Refinancing effected in accordance with the provisions of Schedule 28 – Refinancing.

8.4 Compliance with Lending Agreements

- (a) Project Co shall keep the Lending Agreements in good standing to the extent necessary to perform its obligations under this Project Agreement and the Project Documents, and shall ensure that none of the terms and conditions of the Lending Agreements shall prevent Project Co from performing its obligations under this Project Agreement or the Project Documents.

9. CONTRACTING AUTHORITY RESPONSIBILITIES

9.1 General

- (a) Contracting Authority shall, at its own cost and risk:
 - (i) perform all of its obligations under, and observe all provisions of, this Project Agreement in compliance with Applicable Law;
 - (ii) obtain, maintain, and, as applicable, renew Contracting Authority Permits, Licences, Approvals and Agreements which may be required for the performance of the Works;
 - (iii) comply with all Permits, Licences, Approvals and Agreements in accordance with their terms; and
 - (iv) cooperate with Project Co in the fulfillment of the purposes and intent of this Project Agreement, provided, however, that Contracting Authority shall not be under any obligation to perform any of Project Co's obligations under this Project Agreement.
- (b) Contracting Authority shall, and shall cause all Contracting Authority Parties to, take reasonable steps to minimize undue interference with the provision of the Works by Project Co or any Project Co Party.
- (c) Nothing in this Project Agreement shall in any way fetter the right, authority and discretion of Contracting Authority or any Province Person or Government Entity in fulfilling its statutory or other functions under Applicable Law, and Project Co understands and agrees that nothing in this Project Agreement shall preclude IO's board of directors or Metrolinx's board of directors (or any respective designate appointed pursuant to Section 53.1 of this Project Agreement) from performing, discharging or exercising its duties, responsibilities, and powers under Applicable Law. Project Co further agrees that it shall comply, and shall cause all relevant Project Co Parties to comply, with all written directions issued by or on behalf of IO's board of directors and Metrolinx's board of directors (or any respective designate appointed pursuant to Section 53.1 of this Project Agreement) from time to time, subject to Section 31.1(b).
- (d) Except as set out in Section 6.2, IO and Metrolinx shall be liable, on a joint and several basis, for all of the obligations of Contracting Authority under this Project Agreement and for each covenant

of the other under this Project Agreement. For clarity, the joint and several liability of Metrolinx pursuant to this Project Agreement is solely in its capacity as Crown agency of the Province.

10. PROJECT CO RESPONSIBILITIES – GENERAL

10.1 Other Business

- (a) Project Co shall not engage in any activities which are not specifically related to, required by and conducted for the purpose of the Project without the prior written consent of Contracting Authority, in its sole discretion.

10.2 Complete and Operational New Metrolinx Infrastructure and New Third Party Infrastructure

- (a) Project Co shall design, engineer, construct and commission the New Metrolinx Infrastructure and the New Third Party Infrastructure so as to provide Contracting Authority with complete and operational New Metrolinx Infrastructure and New Third Party Infrastructure in accordance with the Output Specifications, and the Project Co Proposal Extracts, and that will allow Project Co to perform the Works, all in accordance with and subject to the terms of this Project Agreement.

10.3 General Responsibilities and Standards

- (a) Project Co shall, at its own cost and risk, perform and complete the Works:
- (i) in accordance with the Project Works Schedules and, in this regard, shall commence the Works no later than the day following Financial Close and, subject to adjustment as provided for in the Project Agreement,
 - (A) achieve Interim Completion by the Scheduled Interim Completion Date;
 - (B) achieve Substantial Completion by the Scheduled Substantial Completion Date;
and
 - (C) achieve Final Completion by the Scheduled Final Completion Date;
 - (ii) in compliance with Applicable Law;
 - (iii) so as to satisfy the Output Specifications;
 - (iv) in compliance with all Permits, Licences, Approvals and Agreements and so as to preserve the existence and continued effectiveness of any such Permits, Licences, Approvals and Agreements;
 - (v) in accordance with Good Industry Practice and to meet the standards followed by professionals, manufacturers, contractors and trades who are experienced in work on infrastructure that is comparable to the New Metrolinx Infrastructure and the New Third Party Infrastructure;
 - (vi) in a manner consistent with the Quality Plans and the Project Co Proposal Extracts;

- (vii) in a timely and professional manner;
 - (viii) with due regard to the health and safety of persons and property;
 - (ix) subject to the other provisions of this Project Agreement, in a manner which will not impair the ability of Contracting Authority, any Province Person or any Government Entity to comply with Applicable Law;
 - (x) subject to the other provisions of this Project Agreement, in a manner which will not impair the performance of the Governmental Activities;
 - (xi) coordinate with the Municipality all Construction Activities relating to Existing Third Party Infrastructure owned by the Municipality and the New Third Party Infrastructure, including the provision of the Project Works Schedule relating to such infrastructure, so as to minimize the impact of Construction Activities on the Municipality and services provided by the Municipality to the public; and
 - (xii) in accordance with all other terms of this Project Agreement.
- (b) Project Co shall cooperate with Contracting Authority in the fulfillment of the purposes and intent of this Project Agreement, provided however that Project Co shall not be under any obligation to perform any of Contracting Authority's obligations under this Project Agreement.
- (c) Intentionally deleted.
- (d) Project Co shall, at its own cost and risk, immediately notify Contracting Authority upon the receipt or notice of (and provide Contracting Authority with copies of any correspondence received in relation to), any incident report, investigation report or similar correspondence (in each case, whether in draft or final form) issued by the MOL or any other Governmental Authority in respect of the Works.
- (e) If Metrolinx executes an agreement with any third party owner of infrastructure which affects this Project (each, a "**Third Party Agreement**") and Metrolinx provides a copy of the Third Party Agreement or a template agreement upon which Metrolinx intends to base a Third Party Agreement (each, a "**Template Third Party Agreement**") to Project Co, then the following shall apply:
- (i) if, at any time prior to the RFP Submission Deadline, Metrolinx provides:
 - (A) a copy of an executed Third Party Agreement to Project Co; or
 - (B) a copy of a Template Third Party Agreement to Project Co, and Metrolinx subsequently enters into a Third Party Agreement on terms and conditions that are not materially inconsistent with the Template Third Party Agreement in a manner that would result in a material change to the Works (including, for clarity, if Metrolinx enters into the Third Party Agreement following the RFP Submission Deadline),
- then Project Co shall, at Project Co's own cost, ensure that Project Co and the Project Co

Parties do not, in any way whatsoever, contravene or cause Metrolinx to contravene the Applicable Third Party Agreement(s).

- (ii) Subject to Section 10.3(e)(iii), if, at any time following the RFP Submission Deadline, Metrolinx provides a copy of a Third Party Agreement to Project Co, then Project Co shall, at Project Co's own cost, ensure that Project Co and the Project Co Parties do not, in any way whatsoever, contravene or cause Metrolinx to contravene the Third Party Agreement
- (iii) Subject to Section 10.3(e)(i), to the extent that Project Co's performance of its obligations set out in Section 10.3(e)(ii) would result in a material change to the Works and would not otherwise be required of Project Co under the Project Agreement, then such change shall, subject and in accordance with Schedule 22 – Variation Procedure, result in a Variation.
- (f) If Project Co has entered into any agreement with a Utility Company with respect to the Works, Project Co shall provide a copy of such agreement to Contracting Authority no later than 15 days after executing such agreement.

11. PROJECT CO RESPONSIBILITIES – DESIGN AND CONSTRUCTION

11.1 Development of Design

- (a) Project Co shall, at its own cost, develop and complete the design of the New Metrolinx Infrastructure and the New Third Party Infrastructure and all Design Data in accordance with the requirements of this Project Agreement, including Schedule 10 – Review Procedure and this Section 11.1.
- (b) In order to develop the detailed design of the New Metrolinx Infrastructure and New Third Party Infrastructure, Project Co shall consult with the Stakeholders (which consultation requirements pursuant to the Environmental Assessments are further described in Schedule 17 – Environmental Obligations) and the Contracting Authority Representative and the Contracting Authority Design Team in an interactive process. If the result of any consultation with Stakeholders is a change to the scope, configuration or size of any New Metrolinx Infrastructure or New Third Party Infrastructure or a change in the Works, then such change shall, subject to and in accordance with Schedule 22 – Variation Procedure, result in a Variation.
- (c) The further development of the design of the New Metrolinx Infrastructure and New Third Party Infrastructure and the process by which it is progressed must fully comply with the requirements of this Project Agreement.
- (d) The Parties agree that Appendices A and B to Schedule 10 – Review Procedure are initial lists of Design Data and other items that will require design review, which Design Data and other items shall include design, procurement and construction documentation (to a scale required by the Contracting Authority Design Team) for each of the following:
 - (i) design development drawings, reports, schedules and specifications progressed from the date of this Project Agreement with extensive user group input, showing all architectural, engineering and landscape design information sufficient to allow for the development of

- working drawings, submitted at 30% completion (the “**Design Development Submittal**”);
- (ii) working drawing documentation, being construction drawings, reports, schedules and specifications progressed from the Design Development Submittal, showing all architectural, engineering and landscape design information in accordance with the requirements of this Project Agreement, submitted at,
 - (A) 60% completion;
 - (B) 90% completion; and
 - (C) 100% completion,(collectively, the “**Construction Document Submittals**”);
 - (iii) Permit, Licence, Approval and Agreement drawings (phased, if applicable); and
 - (iv) all other documentation required pursuant to Schedule 10 – Review Procedure.
- (e) Project Co shall submit to the Contracting Authority Representative for review in accordance with Schedule 10 – Review Procedure all Design Data and other items listed in Section 11.1(d).
- (f) The Design Data and other items listed in Section 11.1(d) must contain, at a minimum, the following additional information:
- (i) identification of the stage of design or construction to which the documentation relates;
 - (ii) all design or construction drawings and specifications necessary to enable the Contracting Authority Representative to make an informed decision as to whether Project Co is permitted to proceed pursuant to Schedule 10 – Review Procedure;
 - (iii) for each stage of the design or construction documentation, a schedule identifying all changes to the relevant documentation that has occurred from the previous stage of design or construction documentation; and
 - (iv) where changes have been submitted, an indication of how the changes meet the requirements of this Project Agreement.
- (g) All design review meetings held by Project Co which Contracting Authority wishes to attend shall be held in Toronto, Ontario unless Contracting Authority otherwise agrees in writing.
- (h) If Project Co commences or permits the commencement of the next level of design or construction of any part or parts of the New Metrolinx Infrastructure prior to being entitled to proceed in accordance with Schedule 10 – Review Procedure and it is subsequently determined in accordance with Schedule 10 – Review Procedure or Schedule 27 – Dispute Resolution Procedure that the design or construction does not comply with this Project Agreement, then Project Co shall forthwith, at its own cost and risk, undo, remove from the New Metrolinx Infrastructure and/or

Metrolinx Lands, replace and restore, as applicable, any parts of the design or construction that do not comply with this Project Agreement.

- (i) Neither Contracting Authority nor any Contracting Authority Party will have any liability:
 - (i) if a document submitted by Project Co and reviewed by Contracting Authority, the Contracting Authority Representative or the Contracting Authority Design Team results in non-compliance with this Project Agreement by Project Co or a breach by Project Co of Applicable Law; or
 - (ii) for any loss or claim arising due to some defect in any documents, drawings, specifications or certificates submitted by Project Co.
- (j) Project Co and Contracting Authority will cooperate with each other in the design review process. Notwithstanding such cooperation by Contracting Authority, such review shall not constitute acceptance of the Works, and Project Co shall remain solely responsible for compliance in full with all requirements of this Project Agreement.
- (k) Project Co shall allow the Contracting Authority Design Team, at any time, a reasonable opportunity to view any items of Design Data, which shall be made available to the Contracting Authority Representative as soon as practicable following receipt of a written request from the Contracting Authority Representative.
- (l) Project Co shall cause the Construction Contractor to establish and maintain a computerized design database which Project Co and Contracting Authority may access remotely by computer to view drawings comprised within the Design Data and to electronically store and print copies of such Design Data.

11.2 Start-Up Meeting

- (a) Within 10 Business Days after the date of this Project Agreement, Project Co and the Design Team shall attend a start-up meeting (the “**Start-Up Meeting**”) with Contracting Authority to set out the design development process in greater detail.
- (b) The agenda for the Start-Up Meeting shall include the following:
 - (i) Project Co’s plan to develop a successful partnership with Contracting Authority for the purpose of supporting Contracting Authority in achieving its vision, mission and core values;
 - (ii) Project Co’s plan to ensure that the Works are completed in accordance with the requirements set forth in this Project Agreement;
 - (iii) Project Co’s process to ensure optimum design quality;
 - (iv) Project Co’s approach to ensure that all Project Co Parties perform the Works, as applicable, as a fully integrated team;

- (v) Project Co's approach to a fully integrated interior design process that includes every element of interior finishes, furniture, fixtures, equipment, occupant signage and wayfinding;
- (vi) a proposed schedule of Works Submittals which is consistent with the Interim Baseline Works Schedule and which provides for a progressive and orderly flow of Works Submittals from Project Co to the Contracting Authority Representative to allow sufficient time for review of each Works Submittal by the Contracting Authority Design Team, taking into account both the resources available to the Contracting Authority Design Team to conduct such review and whether delay in the review of the subject matter of the Works Submittal will have a material impact on Project Co's ability to progress future anticipated Works Submittals and the Works in accordance with the Baseline Works Schedule;
- (vii) Project Co's plan to successfully integrate feedback from consultations with Stakeholders and the Contracting Authority Design Team;
- (viii) Project Co's approach to timing, construction, adjustment and user feedback on required mock-ups; and
- (ix) a communication process that includes an electronic data room and the use of a computerized document tracking system that has the capacity to report, on request, the status of all design and construction documentation.

11.3 Design Workshops

- (a) In order to obtain user input in the preparation of, and prior to submitting, the Design Development Submittals and the Construction Document Submittals, the Parties will hold user group design workshops (the "**Design Workshops**") upon the following terms:
 - (i) the Project Co Representative shall arrange the Design Workshops in consultation with the Contracting Authority Representative;
 - (ii) the Parties shall cooperate to develop a reasonable schedule for the Design Workshops and shall incorporate such schedule into the Baseline Works Schedule;
 - (iii) Project Co shall circulate to the Contracting Authority Representative an agenda for each of the Design Workshops no later than 10 Business Days prior to the relevant Design Workshop;
 - (iv) the Design Workshops shall be held in person in the City of Toronto, Ontario, except where otherwise agreed by the Parties, acting reasonably;
 - (v) in advance of a Design Workshop, Project Co may submit to the Contracting Authority Design Team for comment any interim drafts of any designs or plans required under this Project Agreement, which submissions shall be used to inform Contracting Authority on the development of New Metrolinx Infrastructure and New Third Party Infrastructure design and provide an opportunity for dialog on compliance with the requirements of the Project Agreement. If a Proposal Part corresponds to the interim submissions, then Project

- Co shall ensure that the interim submissions are substantially the same content and level of detail as the corresponding Proposal Part. For greater certainty,
- (A) interim submissions shall be informal and shall not be reviewed in accordance with Schedule 10 – Review Procedure; and
 - (B) the requirement for Project Co to submit interim submissions that are substantially the same content and level of detail as the corresponding Proposal Part, shall not,
 - (I) lessen, reduce or otherwise modify or amend Contracting Authority’s rights under the Project Agreement to review any Design Development Submittals in accordance with Schedule 10 – Review Procedure; or
 - (II) constitute acceptance by the Sponsors of the corresponding Proposal Part or any Design Development Submittal in accordance with Schedule 10 – Review Procedure.
- (vi) Project Co shall maintain minutes of the Design Workshops, including possible design solutions and changes in design, and, within two Business Days after each Design Workshop, Project Co shall provide to the Contracting Authority Representative a copy of the minutes, together with a copy of any notes, comments, sketches, drawings, tracings, lay-outs, plans or diagrams prepared at the Design Workshop;
 - (vii) Contracting Authority and Project Co agree that the subject matter of the Design Workshops shall not be regarded as Works Submittals to which Schedule 10 – Review Procedure applies, and that Contracting Authority shall not be bound by the input provided in connection with the Design Workshops;
 - (viii) Project Co shall submit to Contracting Authority the Design Development Submittals or the Construction Document Submittals, as applicable, for review pursuant to Schedule 10 – Review Procedure; and
 - (ix) the Parties agree that, with respect to the Design Development Submittals and the Construction Document Submittals, the period for review shall be as described in Schedule 10 – Review Procedure.
- (b) Following Project Co’s submission of the 30% Design Development Submittal, the Parties will hold a Design Workshop with respect to the matters related to the applicable Design Development Submittal, and any other Design Workshops required by Project Co or Contracting Authority, acting reasonably.
 - (c) Following Project Co’s submission of each of the 60% Construction Document Submittal, the 90% Construction Document Submittal, and the 100% Construction Document Submittals, the Parties will hold a Design Workshop with respect to the matters related to the applicable Construction Document Submittal, and any other Design Workshops required by Project Co or Contracting Authority, acting reasonably.

- (d) The purpose of the Design Workshops is to facilitate the incorporation of the Contracting Authority Design Team and user input, involvement and feedback into the Design Data prior to submission of such Design Data in accordance with Schedule 10 – Review Procedure.
- (e) The applicable third party owners of New Third Party Infrastructure may attend Design Workshops relating to New Third Party Infrastructure.

11.4 Performance of Design Obligations

- (a) In the design and engineering of the Project, Project Co, its consultants and the Project Co Parties shall, at a minimum, exercise the standard of care normally exercised by licensed or registered professional architectural and engineering personnel having specialized knowledge and experience in performing design activities of a similar nature, scope and complexity.
- (b) Project Co shall ensure that all parts of the Works shall, as required by Applicable Law, be performed or reviewed by licensed or registered professional engineers and architects registered to practice in the Province of Ontario. Such architects and engineers shall certify and, if required by Applicable Law, sign and seal, all designs, drawings and technical reports confirming that they comply with all prevailing design standards and design practices for such work in the Province of Ontario, all other applicable standards, Output Specifications and codes, and as otherwise required by Applicable Law.

11.5 Works Submittals

- (a) Any and all items, documents and anything else required or specified by this Project Agreement in respect of the Works to be submitted to, reviewed or otherwise processed by Contracting Authority prior to Substantial Completion, including any and all subsequent revisions, amendments and changes thereto, shall be subject to review by Contracting Authority pursuant to Schedule 10 – Review Procedure. The first document to be submitted by Project Co for review by Contracting Authority pursuant to Schedule 10 – Review Procedure shall be the draft document control and security protocol described in Section 42.5(f).

11.6 Documents

- (a) Project Co shall keep one copy of the current digital files of the Project Agreement, Project Documents, Project Works Schedules, Basis of Works Schedule Reports, Works Schedule Reports, submittals, reports, Variation Confirmations, Project Co Variation Notices, Variation Directives, partnering documents, records of meetings and all other documents necessary for the administration of the Project, all in good order and readily accessible and available to Contracting Authority, Lenders' Consultant and Contracting Authority Representative. Project Co shall keep a daily log readily available and accessible to Contracting Authority, Lenders' Consultant and Contracting Authority Representative at all times.
- (b) Project Co shall, where practical, keep one copy of current standards and manufacturers' literature specified in the Project Documents in good order and readily accessible and available to Contracting Authority Representative and Lenders' Consultant and their representatives for the duration of the Works.

11.7 General Construction Obligations

- (a) Without limiting Section 10.3:
- (i) Project Co is solely responsible for all construction means, methods and techniques used to undertake the Works and must provide everything (including labour, Plant, equipment and materials) necessary for the construction and commissioning of the New Metrolinx Infrastructure and the New Third Party Infrastructure, and all other performance of the Works.
 - (ii) Project Co shall in a timely and professional manner and in accordance with the requirements of this Project Agreement:
 - (A) construct the Works diligently, expeditiously and in a thorough and workman-like manner consistent with Schedule 11 – Quality Management;
 - (B) ensure that
 - (I) no works other than the Works under this Project Agreement are constructed on the Lands, the New Metrolinx Infrastructure, the New Third Party Infrastructure or the Existing Infrastructure by Project Co, any Project Co Party or any person for whom Project Co is responsible at law; and
 - (II) the New Metrolinx Infrastructure is constructed only on the Metrolinx Lands in accordance with Schedule 15 – Output Specifications;
 - (C) protect the Works from all of the elements, casualty and damage;
 - (D) in respect of Plant, equipment, Products and materials incorporated in the Works, use Plant, equipment, Products and materials that:
 - (I) are of a kind that are consistent with the Output Specifications;
 - (II) are new, of good quality and are used, handled, stored and installed in accordance with Applicable Law and Good Industry Practice, including, with respect to health and safety, so as not to be hazardous or dangerous; and
 - (III) where they differ from the Output Specifications, have been substituted with Contracting Authority’s prior written consent in accordance with Section 11.20.
 - (iii) Without limiting Project Co’s obligations pursuant to Section 11.11 or Project Co’s indemnity pursuant to Section 46.1, Project Co shall, at all times throughout the progress of the Works, be responsible for maintaining and securing the Metrolinx Lands to prevent access onto the Metrolinx Lands, the New Metrolinx Infrastructure, the New Third Party Infrastructure and the Existing Infrastructure of any persons not entitled to be there, and

the licence granted to Project Co pursuant to Section 16.1 shall include rights for Project Co to do so.

- (iv) Project Co shall not, and Project Co shall ensure that the Project Co Parties do not, in any way whatsoever, contravene or cause a contravention of any labour-related contractual obligation or agreement or any provision of any collective agreement to which the Municipality is a party that is applicable to the New Third Party Infrastructure owned by the Municipality and constructed pursuant to this Project Agreement, as such collective agreements or labour-related agreements may be amended from time to time.
- (b) Project Co shall provide a new construction site office for use by Contracting Authority, at the location(s) specified in Schedule 15 – Output Specifications, and in accordance with the requirements set out in Schedule 15 – Output Specifications, not less than 15 days prior to the commencement of Construction Activities.

11.8 Permits, Licences, Approvals and Agreements

- (a) Subject to Sections 11.8(e) and 11.8(g), Project Co shall, at its own cost and risk:
 - (i) obtain, maintain, and, as applicable, renew all Project Co Permits, Licences, Approvals and Agreements which may be required for the performance of the Works;
 - (ii) except for those obligations which are identified as Contracting Authority obligations in Appendix A to Schedule 1 – Permits, Licences, Approvals and Agreements, assume all of the obligations of Contracting Authority under the Contracting Authority Permits, Licences, Approvals and Agreements (and for greater certainty, the Development Approvals);
 - (iii) comply with all Permits, Licences, Approvals and Agreements in accordance with their terms; and
 - (iv) provide all security, including all letters of credit, that may be required in connection with any Project Co Permits, Licences, Approvals and Agreements, provided that, if Contracting Authority is able to obtain an exemption from such security on behalf of Project Co and with respect to the Project,
 - (A) Project Co shall provide to Contracting Authority an accurate accounting of the costs and expenses avoided by Project Co as a result of any such exemption; and
 - (B) Notwithstanding any other provision of this Project Agreement, Contracting Authority shall be permitted to deduct an amount equal to all costs and expenses that were avoided by Project Co as a result of any such exemption from any Milestone Payment or the Substantial Completion Payment.
- (b) Where any Permits, Licences, Approvals and Agreements have requirements that may impose any conditions, liabilities or obligations on Contracting Authority or any Province Person, Project Co shall not obtain, amend or renew such Permits, Licences, Approvals and Agreements without the prior written consent of Contracting Authority, provided that neither Contracting Authority nor any Province Person shall be responsible for obtaining or for the failure of Project Co to obtain

- any Permit, Licence, Approval and Agreement or for the failure of Project Co to renew any Contracting Authority Permit, Licence, Approval and Agreement. Contracting Authority shall comply, or shall require compliance, with any conditions, liabilities or obligations as are imposed on Contracting Authority or any Province Person by the requirements of any Permit, Licence, Approval and Agreement obtained with Contracting Authority's consent under this Section 11.8(b).
- (c) Contracting Authority shall provide Project Co with such information and administrative assistance as Project Co may reasonably require in relation to the Permits, Licences, Approvals and Agreements. In respect of Section 11.8(a)(ii), Contracting Authority shall,
- (i) provide Project Co with relevant information and copies of notices received under the applicable Contracting Authority Permits, Licences, Approvals and Agreements; and
 - (ii) execute any documents under the applicable the Contracting Authority Permits, Licences, Approvals and Agreements which Applicable Law dictates that only Contracting Authority can execute.
- (d) Project Co shall, at its own cost, provide or cause to be provided such information, documentation, and administrative assistance as Contracting Authority may request and as Project Co may reasonably be able to provide, and shall execute such applications or documents as are required to be in its name, to enable Contracting Authority to obtain, maintain or renew any Contracting Authority Permits, Licences, Approvals and Agreements or to demonstrate compliance with any Permits, Licences, Approvals and Agreements, provided that Project Co shall not be responsible for obtaining or for any delay in obtaining or for the failure of Contracting Authority to obtain any of the Contracting Authority Permits, Licences, Approvals and Agreements, unless such delay or failure is caused by any act or omission of Project Co, any Project Co Party or any other person for whom Project Co is responsible at law.
- (e) If, prior to the Scheduled Substantial Completion Date, the City of Toronto fails to issue to Project Co a final determination (a granting, conditional granting, or refusal) in respect of a Listed Project Co PLAA prior to the expiration of 130 per cent times the number of Business Days designated for a final determination by the City of Toronto in Appendix A-2 to Schedule 1 – Definitions and Interpretation for the applicable Listed Project Co PLAA (the “**City PLAA Deadline**”), then any delay in any Project Works Schedule or additional costs in respect of the Works caused by the failure to make a final determination by the City PLAA Deadline shall, subject to and in accordance with Section 32, be treated as a Delay Event and, subject to and in accordance with Section 33, be treated as a Compensation Event, provided that:
- (i) the applicable Permit, Licence, Approval or Agreement is a Listed Project Co PLAA;
 - (ii) Project Co has fulfilled all obligations pursuant to the Applicable Law, in accordance with any deadline imposed by this Project Agreement or the City of Toronto, including providing timely and thorough responses to questions or concerns posed by the City of Toronto in respect of the Listed Project Co PLAA;
 - (iii) Project Co submitted the applicable Listed Project Co PLAA in accordance with the timing for such submission in the Project Works Schedule; and

- (i) Project Co's application for the Listed Project Co PLAA and Project Co's responses to all questions or concerns posed by the City of Toronto were in accordance with Good Industry Practice.
- (f) For clarity, Section 11.8(e) does not entitle Project Co to a Delay Event or a Compensation Event,
 - (i) in the event that the City of Toronto's final determination on a Listed Project Co PLAA is made in a timely way, pursuant to the applicable City PLAA Deadline, but is not favourable to Project Co or Project Co disagrees with the substance of the final determination;
 - (ii) in the event that the City of Toronto fails to issue to Project Co a final determination in respect of a Permit, Licence, Approval or Agreement that is not explicitly listed as a Listed Project Co PLAA; or
 - (iii) with respect to Permits, Licences, Approvals or Agreements that are related to, but not explicitly included on, the Listed Project Co PLAAs.
- (g) If, prior to the Scheduled Substantial Completion Date, TTC fails to issue to Project Co a final determination (a granting, conditional granting, or refusal) in respect of a Listed Project Co PLAA prior to the expiration of 130 per cent times the number of Business Days designated for a final determination by TTC in Appendix A-2 to Schedule 1 – Definitions and Interpretation for the applicable Listed Project Co PLAA (the "**TTC PLAA Deadline**"), then any delay in the Project Works Schedule or additional costs in respect of the Works caused by the failure to make a final determination by the TTC PLAA Deadline shall, subject to and in accordance with Section 32, be treated as a Delay Event and, subject to and in accordance with Section 33, be treated as a Compensation Event, provided that:
 - (i) the applicable Permit, Licence, Approval or Agreement is a Listed Project Co PLAA;
 - (ii) Project Co has fulfilled all obligations pursuant to the Applicable Law, in accordance with any deadline imposed by this Project Agreement or TTC, including providing timely and thorough responses to questions or concerns posed by TTC in respect of the Listed Project Co PLAA;
 - (iii) Project Co submitted the applicable Listed Project Co PLAA in accordance with the timing for such submission in the Project Works Schedule; and
 - (iv) Project Co's application for the Listed Project Co PLAA and Project Co's responses to all questions or concerns posed by TTC were in accordance with Good Industry Practice.
- (h) For clarity, Section 11.8(g) does not entitle Project Co to a Delay Event or a Compensation Event,
 - (i) in the event that TTC's final determination on a Listed Project Co PLAA is made in a timely way, pursuant to the applicable TTC PLAA Deadline, but is not favourable to Project Co or Project Co disagrees with the substance of the final determination;

- (ii) in the event that TTC fails to issue to Project Co a final determination in respect of a Permit, Licence, Approval or Agreement that is not explicitly listed as a Listed Project Co PLAA; or
- (iii) with respect to Permits, Licences, Approvals or Agreements that are related to, but not explicitly included on, the Listed Project Co PLAA.

11.9 Protection of Works and Property

- (a) Project Co shall protect the Works, including the New Metrolinx Infrastructure and the New Third Party Infrastructure, and the property of Contracting Authority on the Lands, including the Existing Infrastructure, and the property adjacent to the Lands, from damage or destruction which may arise as a result of Project Co's operations under this Project Agreement, and Project Co shall be responsible for such damage or destruction, except for any damage or destruction which occurs as a result of acts or omissions by Contracting Authority or any Contracting Authority Party.
- (b) Unless this Project Agreement is terminated in accordance with its terms, if all or any part of,
 - (i) the Works, including the New Metrolinx Infrastructure and the New Third Party Infrastructure (prior to the Handover of the New Third Party Infrastructure) is damaged or destroyed after Substantial Completion as a result of an act or omission of Project Co or a Project Co Party; or
 - (ii) any existing property of Contracting Authority on the Lands, including any Existing Infrastructure, or any property adjacent to the Lands, is damaged or destroyed as a result of an act or omission of Project Co or any Project Co Party,

then Project Co shall, at its own cost and expense, Make Good the Works (including the New Metrolinx Infrastructure and the New Third Party Infrastructure), and the Existing Infrastructure, and repair and replace the property of Contracting Authority on the Lands, including the Existing Infrastructure, and any property adjacent to the Lands, or any part thereof, as applicable, (the "**Reinstatement Work**") promptly and in any event as soon as practicable in the circumstances. Except as otherwise expressly provided in this Project Agreement, damage to or destruction of all or any part of the Works (including the New Metrolinx Infrastructure or the New Third Party Infrastructure) shall not terminate this Project Agreement or relieve Project Co of any of its obligations hereunder or entitle Project Co to any compensation from Contracting Authority. For clarity, after Handover of New Third Party Infrastructure, damage or destruction to the New Third Party Infrastructure shall be dealt with pursuant to the Project Agreement as damage or destruction to the property of third parties.

- (c) Project Co shall not undertake to repair and/or replace any damage or destruction whatsoever to adjacent property without first consulting Contracting Authority and receiving written instructions as to the course of action to be followed.
- (d) Notwithstanding Sections 11.9(b) and 11.9(e), Reinstatement Work carried out by Project Co in respect of New Third Party Infrastructure that is not owned by the Municipality shall be planned and implemented by Project Co in consultation with the applicable third party.

- (e) If the Reinstatement Work is reasonably estimated to cost more than \$[REDACTED] (index linked) or in any other case where the Contracting Authority Representative, having regard to the nature of the damage or destruction, notifies Project Co that a Reinstatement Plan is required (excluding where the damage or destruction occurs before the Final Completion Date and the Contracting Authority Representative acting reasonably considers that the continued application of the Design and Construction Certification Procedure would be able to adequately address the Reinstatement Work without the need for a separate Reinstatement Plan), Project Co shall, as soon as practicable and in any event within 20 Business Days after the occurrence of the damage or destruction or receipt of notification from the Contracting Authority Representative, as the case may be, (or if, with the exercise of all due diligence more than 20 Business Days is reasonably required for such purposes, then within such longer period of time after the occurrence of such damage or destruction or receipt of notification from the Contracting Authority Representative, as the case may be, as may be reasonably required with the exercise of all due diligence, provided Project Co exercises and continues to exercise all such due diligence) submit to the Contracting Authority Representative pursuant to Schedule 10 – Review Procedure a plan (a “**Reinstatement Plan**”) prepared by Project Co for carrying out the Reinstatement Work setting out, in reasonable detail, *inter alia*:
- (i) a description of the Reinstatement Work required to restore, replace and reinstate the damage or destruction;
 - (ii) Project Co’s proposed schedule for the execution of the Reinstatement Work; and
 - (iii) the information required pursuant to Schedule 22 – Variation Procedure as if such plan were an Estimate,
- and the Reinstatement Work must not be commenced until the Contracting Authority Representative consents thereto in accordance with Schedule 10 – Review Procedure except to the extent necessary to address any Emergency or public safety needs. Notwithstanding Section 11.9(c), where there is danger to life or property which arises out of or in connection with the performance of the Works, either Party may, but Project Co shall, immediately take such emergency action as is necessary to remove the danger.
- (f) Project Co shall cause the Reinstatement Work to be carried out in accordance with the Output Specifications and all other applicable requirements under this Project Agreement and, where applicable, in accordance with the Reinstatement Plan consented to by the Contracting Authority Representative in accordance with Schedule 10 – Review Procedure. All designs, plans and specifications in respect of the Reinstatement Work shall be subject to the Design and Construction Certification Procedure. If requested by the Contracting Authority Representative, the persons (and if applicable, a suitable parent entity thereof acceptable to Contracting Authority) retained by Project Co to design and carry out any Reinstatement Work shall, as a condition to their retainer and prior to commencing any Reinstatement Work or design work in connection therewith, enter into a construction contract with Project Co and a direct agreement with Contracting Authority in substantially the same forms as the Design and Construction Contract and the Construction Contractor’s Direct Agreement.
- (g) In the event any Insurance Proceeds under Insurance Policies as referred to in Schedule 30 – Insurance Trust Agreement are available to carry out the Reinstatement Work, such Insurance

Proceeds shall be paid into the Insurance Trust Account and shall be dispensed in accordance with the provisions of the Insurance Trust Agreement to carry out the Reinstatement Work.

- (h) If any Project Co Party has caused damage or destruction to the work of another contractor related to the Project, Project Co agrees upon due notice to settle with the other contractor by negotiation or arbitration in accordance with Section 11.12(g) and Schedule 27 – Dispute Resolution Procedure. If the other contractor makes a claim against Contracting Authority on account of damage or destruction alleged to have been so sustained, the dispute shall be dealt with in substantially the same manner as contemplated in Section 11.12(g) and Schedule 27 – Dispute Resolution Procedure.

11.10 Liability Unaffected

- (a) Project Co shall not be relieved of any liability or obligation under this Project Agreement by the retainer or appointment of any Project Co Party, and Project Co shall cause each Project Co Party, to the extent such Project Co Party performs, or is specified hereunder to perform, the Works, to comply with the obligations of Project Co to Contracting Authority in the same manner and to the same extent as Project Co.
- (b) No inspection, review, comment, approval, verification, confirmation, certification, acknowledgement or audit pursuant to the provisions of this Project Agreement by Contracting Authority, the Contracting Authority Representative, Lenders' Consultant, the Municipality, or anyone on their behalf, nor any failure of any of them to do so, shall relieve Project Co from performing or fulfilling any of its obligations under this Project Agreement or be construed as an acceptance of the Works or any part thereof.

11.11 Safety

- (a) Project Co shall, until Final Completion, and following Final Completion, solely in relation to the Construction Activities,
 - (i) comply with the Contractor Site Specific Safety Manual;
 - (ii) keep the Site (including Existing Third Party Infrastructure on the Site), the Works, the New Metrolinx Infrastructure and the New Third Party Infrastructure in a safe and orderly state, as appropriate in accordance with Good Industry Practice, to avoid danger to persons on the Site (including Existing Third Party Infrastructure on the Site), the New Metrolinx Infrastructure and the New Third Party Infrastructure and in the immediate vicinity of the Site (including Existing Third Party Infrastructure on the Site), the New Metrolinx Infrastructure and the New Third Party Infrastructure;
 - (iii) take such measures as are reasonable in accordance with Good Industry Practice to prevent access to the Site (including Existing Third Party Infrastructure on the Site), the New Metrolinx Infrastructure and the New Third Party Infrastructure of any persons or creatures not entitled to be there;

- (iv) comply, and cause each Project Co Party to comply,
 - (A) with Applicable Law relating to health and safety, including the *Occupational Health and Safety Act* (Ontario) and all regulations thereto;
 - (B) with the Access Management Plan and all rules, requirements and restrictions relating to access, rail safety and operations and track protection, all as set out in Schedule 15 – Output Specifications and Schedule 34 – Rail Corridor Access and Flagging; and
 - (C) with any direction or instruction from Transport Canada arising from any contractual arrangement or board order involving Transport Canada and one or both of MTO or Metrolinx with respect to the Rail Corridor, and facilitate and provide cooperation with respect to any inspections by Transport Canada on the Lands;
 - (v) register the Project with the MOL by way of a Notice of Project, pursuant to the Applicable Law, with the purpose of designating Project Co as the “constructor” for all Works on the Site;
 - (vi) with respect to the Works, cause a COR-Certified Construction Project Co Party or, prior to receipt of COR Certification, a COR-Qualified Construction Project Co Party, to perform, all of the obligations of the “constructor”, and indemnify Contracting Authority, each Province Person and each Government Entity against any and all of the liabilities of the “constructor”, under the *Occupational Health and Safety Act* (Ontario) and all regulations thereto;
 - (vii) provide Contracting Authority with a certificate of good standing from WSIB or any successor thereto once every 90 days; and
 - (viii) facilitate and provide cooperation with respect to any inquiry or investigation of the MOL with respect to the Project.
- (b) Project Co shall cause the Construction Contractor to deliver at least one copy of the Contractor Site Specific Safety Manual to the Site no later than the first Business Day following Financial Close (or such other date as may be agreed by the Parties) and maintain the Contractor Site Specific Safety Manual (as it may be amended by the Construction Contractor from time to time) at the Site until Final Completion, and following Final Completion, during the performance of the Construction Activities.
- (c) New Third Party Infrastructure shall, for all purposes of this Project Agreement, become Existing Third Party Infrastructure upon the earlier of,
- (i) the date that there is a Handover of the New Third Party Infrastructure from Project Co to the applicable third party owner; and
 - (ii) Final Completion.

- (d) At any time that the Works are being carried out in or around the Existing Infrastructure, Project Co shall at all times:
- (i) ensure that it complies with all safety requirements set out in the Project Agreement, including those set out in Section 11.11(a) above; and
 - (ii) keep the Existing Infrastructure in a safe and orderly state, as appropriate and in accordance with Good Industry Practice, to avoid any danger to the System Users, employees, visitors and other persons attending the Existing Infrastructure.
- (e) If the MOL determines, pursuant to the *Occupational Health and Safety Act* (Ontario), that Project Co is not the “constructor” for the Site or any portion thereof, then the following shall apply:
- (i) Project Co shall comply with the instructions of the “constructor” relating to matters of health and safety on the Site, methods and manner of construction, and coordination and scheduling of the “constructor’s” works with the Works.
 - (ii) If Project Co’s activity or presence on the Site, or that of any Project Co Party, in whole or in part, caused MOL to determine that Project Co is not the “constructor” for the Site or any portion thereof, Project Co will immediately take any necessary remedial action, including vacating the Site, to ensure that the MOL determines that Project Co is the “constructor”.
 - (iii) If a third party is named “constructor” by MOL, Project Co shall not interfere with or delay the third party’s work, and shall not do anything whatsoever that causes the third party to be in contravention of its obligations under the *Occupational Health and Safety Act* (Ontario). Project Co shall immediately cease and desist any activity that results or has a likelihood of resulting in such interference with or delay of the work of the third party.
 - (iv) If the MOL determines that either IO or Metrolinx, or both of IO and Metrolinx or a third party contractor has been designated as the “constructor” under the *Occupational Health and Safety Act* (Ontario), and such determination by the MOL is due to an act or omission of Project Co, Project Co shall indemnify Contracting Authority, each Contracting Authority Party and each Government Entity against any and all of the liabilities arising from such determination by the MOL.
- (f) In the event that an act or omission of Project Co causes or contributes to an MOL determination that Project Co is not the “constructor” for the Site or any portion thereof, or if Project Co is denied access to the Site pursuant to Section 11.11(e)(ii), Project Co will not be eligible for a Delay Event or a Compensation Event.
- (g) Project Co shall comply with the requirements set out in Schedule 34 – Rail Corridor Access and Flagging in respect of the interaction between Project Co, CP and any other users of the Rail Corridor with respect to the activities to be performed in, on, under and/or adjacent to the Rail Corridor.

11.12 Additional Works and Third Party Works

- (a) Project Co shall, having regard to Project Co's obligations set out in Section 17, arrange and carry out all coordination of the Works with the Third Party Works directly with the applicable Third Party Contractor.
- (b) Contracting Authority may, in its sole discretion, carry out Additional Works.
- (c) Contracting Authority may assign the responsibility for directing methods and manner of construction (where applicable) of the Additional Works, the coordination and scheduling of the Additional Works and the safety training in respect of the Additional Works to Project Co. For clarity, Contracting Authority may, in its sole discretion, assign such responsibilities to Project Co.
- (d) In connection with the Additional Works, Contracting Authority shall,
 - (i) cause Additional Contractors to comply with the instructions of Project Co relating to matters of health and safety on the Site, methods and manner of construction (where applicable), and coordination and scheduling of the Additional Works with the Works;
 - (ii) enter into separate contracts with Additional Contractors,
 - (A) under conditions of contract which are compatible with the conditions of this Project Agreement;
 - (B) that require Additional Contractors to comply with Section 11.12(e) and all directions of Project Co in respect of any matter regarding health and safety on the Site, and methods and manner of construction (where applicable); and
 - (C) that require Additional Contractors to comply with Project Co's coordination and scheduling of the Additional Works; and
 - (iii) ensure that insurance coverage is provided by each Additional Contractor as would be required by a prudent owner similarly situated and coordinate such insurance with the insurance coverage of Project Co and in any event, such insurance shall provide for liability insurance of not less than \$[REDACTED].
- (e) In connection with the Additional Works, if Contracting Authority has assigned responsibilities to Project Co pursuant to this Section 11.12, Project Co shall,
 - (i) provide for the methods and manner of construction (where applicable) of the Additional Works and the coordination and scheduling of the Additional Works with the Works to be performed under this Project Agreement;
 - (ii) assume overall responsibility for compliance with all aspects of,
 - (A) Applicable Law relating to health and safety at the Site, including all the responsibilities of the "constructor" under the *Occupational Health and Safety Act* (Ontario); and

- (B) the Access Management Plan and all rules, requirements and restrictions relating to access, rail safety and operations and track protection, all as set out in Schedule 15 – Output Specifications and Schedule 34 – Rail Corridor Access and Flagging,
- prior to Substantial Completion and, exercised in a manner consistent with the *Occupational Health and Safety Act* (Ontario), at any time that Project Co is acting as a “constructor” on the Site following Substantial Completion;
- (iii) provide Additional Contractors reasonable opportunity to introduce and store their products and use their construction machinery and equipment to execute the Additional Works, as applicable;
- (iv) participate with Contracting Authority and Additional Contractors in reviewing the construction schedules of Additional Contractors, when directed to do so by Contracting Authority; and
- (v) if part of the Works is affected by or depends upon, for its proper execution, the Additional Works, promptly report to Contracting Authority in writing and prior to proceeding with that part of the Works any readily apparent deficiencies in the Additional Works. Failure by Project Co to so report shall invalidate any claims against Contracting Authority by reason of such readily apparent deficiencies.
- (f) In the case of Additional Works carried out prior to Substantial Completion, if:
- (i) any Additional Contractors cause any damage to the Works;
- (ii) Project Co incurs any additional costs or there is any delay in the Works as a result of any Additional Contractors not complying with the coordination, scheduling and safety instructions of Project Co; or
- (iii) subject to the performance by Project Co of its obligations under this Section 11.12, if Project Co incurs any additional costs or there is any delay in the Works as a result of any such Additional Works (other than Additional Work that is required to meet the Output Specifications and provided such Additional Work is performed by such Additional Contractors in accordance with Good Industry Practice and in accordance with the terms of their respective contracts or engagements with Contracting Authority),
- then any such delay in the Works or additional costs in respect of the Works shall, subject to and in accordance with Section 32 be treated as a Delay Event and, subject to and in accordance with Section 33, be treated as a Compensation Event.
- (g) Claims, disputes, and other matters in question between Project Co and Additional Contractors shall be dealt with in substantially the same manner as contemplated in Schedule 27 – Dispute Resolution Procedure provided that the Additional Contractors and Contracting Authority have made commercially reasonable efforts to ensure that provisions similar to Schedule 27 – Dispute Resolution Procedure have been included in the contracts between Contracting Authority and the Additional Contractors. Project Co shall be deemed to have consented to arbitration of any dispute

- with any Additional Contractor whose contract with Contracting Authority contains a similar agreement to arbitrate.
- (h) In connection with the Additional Works, Project Co may request a Variation as follows:
- (i) Project Co shall have a period of 10 Business Days following Notice from Contracting Authority of Contracting Authority's intention to carry out such Additional Works, including a reasonable description of such Additional Works, to request a Variation if such Additional Works are,
 - (A) reasonably expected to make void a warranty made in favour of Project Co from a Project Co Party or equipment supplier and given in accordance with Good Industry Practice; or
 - (B) reasonably expected to have a material negative consequence on Project Co's ability to perform any of the Works;
 - (ii) If Project Co has made a request for a Variation in accordance with Section 11.12(h)(i), Contracting Authority shall, within 10 Business Days after such request, either issue a Variation Enquiry or give Notice to Project Co that it does not agree that a Variation is required;
 - (iii) Either Party may refer the question of whether a Variation is required as the result of a warranty risk or risk in the performance of the Works for resolution in accordance with Schedule 27 – Dispute Resolution Procedure; and
 - (iv) If Contracting Authority has, under Section 11.12(h)(ii), given Notice to Project Co that it does not agree that a Variation is required, Contracting Authority shall, within 10 Business Days after a subsequent agreement or of a determination that a Variation is required, issue a Variation Enquiry and the relevant provisions of Schedule 22 – Variation Procedure shall apply except that:
 - (A) Contracting Authority shall not be entitled to withdraw any such Variation Enquiry unless Contracting Authority determines not to proceed with the Additional Works or to proceed only in a manner that the Additional Works will not result in a warranty becoming void or will not result in any material negative consequence on Project Co's ability to perform any of the Works and Project Co has agreed with such conclusion, or the Parties otherwise agree; and
 - (B) the Parties shall, without prejudice to their respective general obligations to comply with the terms of this Project Agreement, use commercially reasonable efforts to mitigate the adverse effects with respect to any void or voidable warranty and take commercially reasonable steps to minimize any increase in costs arising from any void warranty.
 - (i) Placing, installing, applying or connecting the Additional Works performed by Additional Contractors on and to the Works performed by Project Co shall not relieve Project Co from its obligations under the Project Agreement with respect to the Works, except to the extent expressly described in any Variation Confirmation.

11.13 Protest and Trespass

- (a) Except as otherwise provided in this Project Agreement, Contracting Authority shall not be responsible for the presence of any persons participating in civil disobedience, demonstration or protest action (“**Protesters**”) or any other persons otherwise not entitled to be on or around the Lands (“**Trespassers**”). For greater certainty, the presence of, or interference by, any Protesters or Trespassers on or around the Metrolinx Lands shall not be a breach of the obligation of Contracting Authority to grant licence rights of use and access to Project Co on and over the Metrolinx Lands pursuant to Section 16 nor a breach of any other obligation, representation or warranty under this Project Agreement.
- (b) The management of any Protesters or Trespassers shall be the responsibility of Project Co in respect of the Site (including Existing Third Party Infrastructure on the Site), Metrolinx Lands, New Third Party Infrastructure and New Metrolinx Infrastructure, to the extent such management is not otherwise the responsibility of the Police Service.
- (c) If Protesters or Trespassers occupy the Site, lands, facilities or infrastructure referred to in Section 11.13(b), or access to such Site, lands, facilities, or infrastructure is prevented or interfered with by Protesters or Trespassers, Project Co shall use all appropriate measures reasonable in the circumstances to manage such Protesters or Trespassers and promptly notify the Contracting Authority Representative of such occurrence and of the action which Project Co proposes to take in respect thereof. Project Co may exercise any legal remedy available to it to remove Protesters or Trespassers from the Site, lands, facilities or infrastructure referred to in Section 11.13(b), provided that if Project Co does elect to exercise any such legal remedy, Project Co shall give the Contracting Authority Representative at least 24 hours’ Notice prior to commencing any such legal proceeding (except in a case of Emergency, danger to persons or material destruction or material damage to property where, in such circumstances, such Notice may be given to Contracting Authority less than 24 hours prior to the commencement of such legal proceeding) and shall continually update the Contracting Authority Representative as to the status of any such legal proceeding in reasonable detail and at reasonable intervals, and provided further that:
- (i) Project Co shall not give directly or indirectly to any Protester or Trespasser any inducement, monetary or otherwise, with a view to avoiding, limiting or influencing the manner of protest activities by that Protester or Trespasser or by other Protesters or Trespassers; and
- (ii) Project Co shall not by virtue of this Section 11.13(c) be prevented from entering into *bona fide* settlements of claims brought against it by Protesters or Trespassers which provide for reasonable payments in satisfaction of such claims or agreeing to any reasonable cost orders in any proceedings.
- (d) Project Co may request the assistance of Contracting Authority (at the cost of Project Co) to remove Protesters or Trespassers from the Site, lands, facilities or infrastructure, set out in Section 11.13(b) if Project Co demonstrates to Contracting Authority’s reasonable satisfaction that:
- (i) Project Co is pursuing legal remedies available to it to remove the Protesters or Trespassers (provided that for this purpose Project Co may, but shall not be obligated to, prosecute injunctive or other judicial remedies beyond the court of first instance); and

- (ii) the continued presence of the Protesters or Trespassers is having a material adverse effect on the conduct of the Works that Project Co is unable to mitigate.

Following such request, Contracting Authority shall notify Project Co whether Contracting Authority can lawfully provide any assistance in relation to the removal of the Protesters or Trespassers that is not independently available to Project Co and, to the extent that such assistance can be lawfully provided, Contracting Authority shall provide such assistance (at the cost of Project Co) to the extent it is, in the discretion of Contracting Authority, reasonable and appropriate in the circumstances to do so.

11.14 Adjacent Developments

- (a) Project Co shall,
 - (i) coordinate and cooperate with, and provide commercially reasonable assistance to Contracting Authority with respect to proposed Adjacent Developments referred by Contracting Authority to Project Co; and
 - (ii) carry out all other obligations with respect to Adjacent Developments as set out in Schedule 15 – Output Specifications.
- (b) Project Co shall avoid or mitigate any adverse impact of an Adjacent Development on the Works and the New Metrolinx Infrastructure.
- (c) Project Co shall permit the developer of the Adjacent Development to post or affix signage on the Metrolinx Lands, as and if required by any Municipality and in locations required by such Municipality, in connection with such Adjacent Development application.
- (d) Project Co shall provide to the developer of the Adjacent Development all Project documentation in respect of the design and construction of elements of the New Metrolinx Infrastructure that may be impacted by the proposed Adjacent Development, subject to the developer of the Adjacent Development executing a confidentiality agreement and a waiver of liability, each in a form and substance satisfactory to Contracting Authority and Project Co, each acting reasonably.

11.15 Defective Works

- (a) Prior to Substantial Completion:
 - (i) Project Co shall promptly Make Good any deficiency, defect or error in the Works or failure of the Works to conform to the Project Agreement, or any deficiency, defect or error in relation to any Product (collectively, a “**Construction Defect**”) whether or not such Construction Defect has been incorporated into the New Metrolinx Infrastructure or the New Third Party Infrastructure and whether or not the Construction Defect is the result of poor workmanship, use of defective Products or equipment or damage through carelessness or other act or omission of Project Co. The correction of Construction Defects shall be at Project Co’s sole cost and expense. Project Co shall Make Good, in a manner acceptable to the Independent Certifier, all Construction Defects, whether or not they are specifically identified by the Independent Certifier, and Project Co shall prioritize the correction of any Construction Defects so as not to interfere with or derogate from the

Project Works Schedules, provided that Project Co shall prioritize the correction of any Construction Defects that in the sole discretion of Contracting Authority is determined to adversely affect the day to day operation of Contracting Authority.

- (ii) Project Co shall Make Good promptly other contractors' work destroyed or damaged by such rectifications at Project Co's expense.
- (iii) If in the opinion of the Independent Certifier it is not expedient for Project Co to correct any Construction Defects, Contracting Authority may deduct from the amount of the Guaranteed Price the difference in value between the Works as performed and that called for by the Project Agreement. If Contracting Authority and Project Co do not agree on the difference in value, they shall refer the matter to the Independent Certifier for a determination and the determination will be issued as a Variation.

11.16 Warranty Obligations

- (a) Project Co represents, warrants and covenants that:
 - (i) the Works, including the New Metrolinx Infrastructure, the New Third Party Infrastructure, and all Products, parts and workmanship, including those replaced during the Warranty Period, shall,
 - (A) conform to the requirements and specifications set out in this Project Agreement, Good Industry Practice, Applicable Law and all professional engineering principles generally accepted as standards of the industry in the Province of Ontario;
 - (B) be free of defects, including design defects, errors and omissions; and
 - (C) be new, of good quality material, of merchantable quality and fit for their intended purpose as described in the Project Agreement; and
 - (ii) materials and equipment shall be of good quality and in compliance with this Project Agreement.
- (b) During each Warranty Period, Project Co shall promptly, at its sole cost and expense,
 - (i) subject to Section 11.16(b)(ii), correct and Make Good all Construction Defects arising in respect of the Works. For greater certainty, Project Co is required to correct and Make Good Construction Defects related to any Product and any equipment during the applicable Warranty Period despite Project Co having obtained on Contracting Authority's behalf industry-standard or other equipment warranties in accordance with Section 11.16(e); and
 - (ii) correct and Make Good any Construction Defects that could not reasonably have been ascertained by a competent person in accordance with Good Industry Practice during a visual inspection of the Works ("**Construction Latent Defect**"), provided Contracting Authority gives Project Co-written Notice of the Construction Latent Defect within the

time frame applicable to such Construction Latent Defect pursuant to the *Limitations Act*, 2002 (Ontario).

- (c) The warranties set out in this Section 11.16 shall each cover labour and material, including, the costs of removal and replacement of covering materials. None of the warranties shall limit extended warranties on any Product or any item of equipment called for elsewhere in Schedule 15 – Output Specifications or otherwise provided by any manufacturer of such Product or item of equipment. Project Co shall ensure that all extended warranties specified in the Project Agreement are provided and shall, in the case of the New Third Party Infrastructure, assign to the third party owner of the New Third Party Infrastructure all such extended warranties as the third party owner may direct.
- (d) Intentionally Deleted.
- (e) Project Co shall obtain warranties from the manufacturers of each of the Products and items of equipment for the duration(s) and in accordance with the applicable requirements specified in Schedule 15 – Output Specifications in the name of and to the benefit of Project Co, Contracting Authority in the case of New Metrolinx Infrastructure, and the applicable third party owner in the case of New Third Party Infrastructure. Where, in respect of a Product warranty or equipment warranty, the Output Specifications do not specify a specific duration and/or other requirements, Project Co shall obtain industry-standard warranties from the applicable manufacturers in the name of and to the benefit of Project Co and Contracting Authority which shall extend no less than the applicable Warranty Period. Each Product warranty and equipment warranty shall be issued by the applicable manufacturer and delivered to Project Co no later than 30 days prior to the Interim Completion Date, with respect to the Interim Completion Works, and the Substantial Completion Date, with respect to the Remainder Works. Project Co shall ensure that each Product warranty and equipment warranty, including any Product warranty or equipment warranty extended under this Section 11.16(e), is fully assigned to Contracting Authority or the third party owner of New Third Party Infrastructure, as applicable, at no cost or expense to Contracting Authority or the third party owner, at the end of the Warranty Period, as such Warranty Period may be extended in accordance with Section 11.17(a).
- (f) Contracting Authority may, in its sole discretion, assign the Project Co warranties set out in this Section 11.16 to the applicable third party owner of the New Third Party Infrastructure, and shall provide Notice to Project Co of any such assignment of Project Co warranties. On the commencement of the first Warranty Period for each of the New Metrolinx Infrastructure and the New Third Party Infrastructure, Project Co shall provide at least two copies of each of the compilations of warranty certificates, one compilation for each of the New Metrolinx Infrastructure and one compilation for each category of New Third Party Infrastructure, as categorized by ownership of the New Third Party Infrastructure. Project Co shall update all copies of each of the compilations from time to time as each Warranty Period commences. Each of the compilations shall indicate the start and completion date of each Project Co warranty.
- (g) Subject to Section 11.12, Project Co acknowledges that,
 - (i) with respect to the New Metrolinx Infrastructure, Contracting Authority may, in its sole discretion; and

- (ii) with respect to the New Third Party Infrastructure, the applicable third party owner may, in its sole discretion,

maintain, repair and/or alter any part or parts of the Works during the applicable Warranty Period and Project Co agrees that such work shall not impact any of the warranties provided by Project Co hereunder, provided that such work is carried out in accordance with Good Industry Practice and that such work does not materially alter the affected part or parts of the Works.

11.17 Warranty Work and Prompt Repair of Warranty Work

- (a) Project Co shall carry out all work, including correcting Construction Defects and Construction Latent Defects, to satisfy the warranties provided pursuant to this Section 11.17, and in accordance with the applicable Warranty Period, and Project Co shall also Make Good any damage to other works caused by the repairing of such defects, deficiencies, or failures to comply (the “**Warranty Work**”). All Warranty Work shall be carried out and completed at Project Co’s sole cost and expense and Warranty Work shall not be the basis of a claim for a Delay Event, a Compensation Event, a Variation, additional compensation or damages. The applicable Warranty Period shall be extended for a further two years from the date of the last Warranty Work completed and accepted by Contracting Authority in respect of the New Metrolinx Infrastructure and by the applicable third party owner in respect of the New Third Party Infrastructure. For clarity, any extension of a Warranty Period for the purposes of a correction shall only apply to the relevant Warranty Work and not the Works as a whole.
- (b) Project Co acknowledges and agrees that, the timely performance of Warranty Work is critical to the ability of Contracting Authority to maintain effective operations of the New Metrolinx Infrastructure, and to the ability of the third party owner to maintain effective operations of the New Third Party Infrastructure. Project Co shall use commercially reasonable efforts to respond to any requirement by Contracting Authority or the third party owner to perform Warranty Work within the time periods required by Contracting Authority or the third party owner to perform the Warranty Work for the New Metrolinx Infrastructure or the New Third Party Infrastructure. Project Co shall commence and complete Warranty Work as expeditiously as possible and at times convenient to Contracting Authority, which may require work outside normal working hours at Project Co’s expense. Any extraordinary measures required to complete such Warranty Work, as directed by Contracting Authority or the applicable third party to accommodate the operation of the New Metrolinx Infrastructure, the New Third Party Infrastructure or other aspects of the Project as constructed, shall be at Project Co’s sole cost and expense. In relation to critical areas required for effective operations, Project Co shall commence, carry out and complete Warranty Work on an urgent basis with all due haste, taking into account the circumstances and any timelines for commencement and completion as may be communicated by Contracting Authority, with respect to the New Metrolinx Infrastructure, or the third party owner, with respect to the New Third Party Infrastructure, to Project Co.
- (c) Project Co acknowledges and agrees that if,
 - (i) Contracting Authority with respect to the New Metrolinx Infrastructure; or
 - (ii) the third party owner of the New Third Party Infrastructure,

is unable to contact Project Co and/or obtain the Warranty Work promptly, or, in the case of urgent Warranty Work within the time period set out in Section 11.17(b), Contracting Authority and the applicable third party owner, as applicable, may take such emergency steps as are reasonable and appropriate to correct any defects, deficiencies or failures to comply with the Project Agreement, at Project Co's sole cost and expense. Except in the case of damage caused by Contracting Authority's or the third party owner's own forces, such emergency steps taken by Contracting Authority's or the third party owner's own forces, as applicable, shall not invalidate any Project Co warranties in respect of the Works.

- (d) If Project Co fails to carry out the Warranty Work in accordance with Section 11.16, and in the time specified in Section 11.17(b) or subsequently agreed upon, without prejudice to any other right or remedy Contracting Authority may have, Contracting Authority and the third party owner, as applicable, may correct the Works at the sole risk, cost and expense of Project Co and may draw down on the Warranty Letter of Credit to fund or as reimbursement for such costs and expenses.
- (e) Project Co acknowledges and agrees that all rules, requirements and restrictions relating to access, rail safety and operations and track protection, all as set out in Schedule 15 – Output Specifications and Schedule 34 – Rail Corridor Access and Flagging, apply to Project Co's performance of its obligations in accordance with Sections 11.16 and 11.17.
- (f) After the Handover of the New Third Party Infrastructure, Project Co shall be solely responsible for obtaining access from the applicable third party for the purpose of carrying out Warranty Work. Project Co acknowledges that such access to the New Third Party Infrastructure may be subject to such limitations as may be imposed by the applicable third party owner, and that Project Co may be required to obtain a Permit, Licence, Approval or Agreement to access the New Third Party Infrastructure for the purpose of carrying out Warranty Work. If, after making commercially reasonable efforts and otherwise complying with its obligations pursuant to this Project Agreement, Project Co is unable to obtain access to the New Third Party Infrastructure, Project Co shall refer the matter to Contracting Authority.
- (g) The warranties set out in Sections 11.16 and 11.17 shall not deprive Contracting Authority or any third party owner of New Third Party Infrastructure of any action, right or remedy otherwise available to Contracting Authority or the third party owner at law or in equity, and the periods referred to in this Section 11.17, shall not be construed as a limitation on the time in which Contracting Authority or the third party owner may pursue such other action, right or remedy.
- (h) Neither test results, nor selection or approval by Contracting Authority or the Contracting Authority Representative of testing entities, nor any other thing in the Project Agreement shall have the effect of limiting or shortening or otherwise affecting in any way whatsoever the duration, effectiveness or content of any guarantee or warranty set forth in any other document or material forming part of the Project Agreement.

11.18 Warranty Letter of Credit

- (a) On or before the Substantial Completion Date, Project Co shall deliver, or cause to be delivered, to Contracting Authority an unconditional and irrevocable letter of credit from any one or more of the Schedule I Canadian chartered banks or any other financial institutions approved by Contracting Authority in Contracting Authority's sole and absolute discretion, in each case, whose

current long-term issuer rating is at least “A” by Standard & Poor’s and “A2” by Moody’s Investor Services or an equivalent rating by another party acceptable to Contracting Authority, in its sole and absolute discretion, in favour and for the direct and exclusive benefit of Contracting Authority, in the form set out in Schedule 7B – Warranty Letter of Credit (the “**Warranty Letter of Credit**”). The Warranty Letter of Credit shall be in the amount equal to \$5,000,000 (the “**Required Amount**”).

- (b) Notwithstanding Section 4.3(c), if the Warranty Letter of Credit has not been delivered to Contracting Authority by the Substantial Completion Payment Date, Contracting Authority may withhold from the Substantial Completion Payment a holdback amount of \$5,000,000 (the “**Warranty Cash Amount**”). In such an event, the Warranty Cash Amount may be withheld by Contracting Authority until the date that is two Business Days following the date that the Warranty Letter of Credit has been delivered to Contracting Authority and, upon such second Business Day, the Warranty Cash Amount, less the amount of any claims previously satisfied by a draw in accordance with Section 11.19(c), shall be paid by Contracting Authority to Project Co. Until receipt of the Warranty Letter of Credit, Contracting Authority may use the Warranty Cash Amount in the place of, in the same manner as and for the same purpose as the Warranty Letter of Credit. The withholding of the Warranty Cash Amount in accordance with this Section 11.19(b) until Project Co’s delivery of the Warranty Letter of Credit to Contracting Authority shall be Contracting Authority’s sole remedy for failure on the part of Project Co to deliver the Warranty Letter of Credit by the Substantial Completion Payment Date and, for greater certainty, Contracting Authority shall not be entitled to withhold payment of the balance of the Substantial Completion Payment as a result of any such failure on the part of Project Co to deliver the Warranty Letter of Credit.
- (c) Contracting Authority shall be entitled to draw on the Warranty Letter of Credit or the Warranty Cash Amount, as applicable:
 - (i) in an amount equal to the costs estimated by the Independent Certifier for Contracting Authority to rectify defects, deficiencies or non-compliant items in the Works, together with all other damages suffered by Contracting Authority, including any costs incurred by Contracting Authority in accordance with Sections 11.16 and 11.17 as a result of Project Co’s failure to comply with its obligations under Sections 11.16 and 11.17; and/or
 - (ii) to satisfy any amounts that are due and have remained outstanding for 30 days by Project Co pursuant to the terms of this Project Agreement or by the Construction Guarantor pursuant to Schedule 29 – Form of Performance Guarantee of Construction Guarantor
- (d) Contracting Authority may make multiple calls on the Warranty Letter of Credit.
- (e) In the event that Contracting Authority draws on the Warranty Letter of Credit or the Warranty Cash Amount, Project Co shall forthwith, and in any event within 5 Business Days following such draw, provide Contracting Authority with a replacement or additional letter of credit such that the Warranty Letter of Credit(s) is at all times during the Warranty Periods in the Required Amount.
- (f) Unless the Warranty Letter of Credit is fully drawn by Contracting Authority in accordance with the provisions of this Project Agreement, Contracting Authority shall release and deliver the Warranty Letter of Credit to Project Co on the day following the date that is two years following the Substantial Completion Date.

- (g) In the event the Warranty Letter of Credit has an expiry date that is prior to the end of the Warranty Period and Project Co does not renew (or does not cause the renewal of) the Warranty Letter of Credit and does not provide (or cause the provision of) proof of such renewal to Contracting Authority before the date that is 20 calendar days before the Warranty Letter of Credit's expiry date, then at any time during such 20 calendar day period and upon providing prior written Notice to Project Co, Contracting Authority may draw upon the full amount of the Warranty Letter of Credit and deposit the cash proceeds thereof in a segregated bank account selected by Project Co (provided that such bank account must be at a bank that meets the thresholds described in Section 11.18(a) and if Project Co does not promptly select such bank account then such bank account may be selected by Contracting Authority in its sole and absolute discretion) and such cash proceeds shall thereupon stand in place of the Warranty Letter of Credit until Project Co delivers (or causes the delivery of) a replacement Warranty Letter of Credit to Contracting Authority. All interest earned on such cash proceeds shall be for the benefit of Project Co. Contracting Authority shall be entitled to withdraw such cash proceeds in the same manner that it is permitted to draw upon the Warranty Letter of Credit under Section 11.18(c). Upon the delivery of a replacement Warranty Letter of Credit by Project Co to Contracting Authority, all remaining cash proceeds and all accrued interest thereon from such segregated bank account shall be returned to Project Co or as Project Co may direct within five Business Days after the delivery of such replacement Warranty Letter of Credit by Project Co to Contracting Authority.

11.19 Coordination and Minimization of Disruption and Interference

- (a) Project Co shall perform the Works so as to coordinate with,
- (i) the operations of, and the performance of any services by, Contracting Authority, any Province Person, any Governmental Authority, any Other Contractor, any Railway Company, any Utility Company, the Municipality, and any Municipal Transit System, including the performance of the Governmental Activities and the Other Works; and
 - (ii) the construction of the interface, connection or inter-connection between the New Metrolinx Infrastructure, the New Third Party Infrastructure, and any existing transit systems, rail systems, including Municipal Transit Systems, rail networks, bus routes, and any other Ontario road or roadway.
- (b) Project Co acknowledges and agrees that,
- (i) Project Co has familiarized itself with all operations and activities associated with the Lands, the Existing Infrastructure, the existing transit systems and the rail systems, and will perform the Works in accordance with, and subject to,
 - (A) this Project Agreement, including all rules, requirements and restrictions relating to access, rail safety and operations and track protection, all as set out in Schedule 15 – Output Specifications and Schedule 34 – Rail Corridor Access and Flagging;
 - (B) the Access Management Plan; and

- (C) the requirements of Contracting Authority and other third parties,
in order to maintain normal operations and activities associated with the Lands, the Existing Infrastructure, the existing transit systems and the rail systems;
 - (ii) the carrying on of Contracting Authority Activities during construction is a priority for Contracting Authority, and Project Co has reviewed the Project Documents with respect to this;
 - (iii) Project Co shall use all methods required to comply with the instructions set out in this Project Agreement during the performance of the Works, Project Co shall fully cooperate with Contracting Authority in complying with such instructions during the performance of the Works, and any costs incurred by Project Co in complying with said instructions shall be part of the Guaranteed Price; and
 - (iv) the Project Agreement includes specifications which include instructions respecting Contracting Authority's use of the Existing Infrastructure, Project Co has read and understood such instructions and shall comply with the procedures set out therein, and Project Co shall be responsible for any costs and expenses resulting in its failure to comply with these procedures.
- (c) Except as explicitly permitted by Contracting Authority or this Project Agreement, and subject to Project Co's compliance with all applicable Permits, Licences, Approvals and Agreements,
- (i) Project Co shall minimize disturbance to and interference with,
 - (A) the existing transit systems, the Existing Infrastructure and the rail systems in accordance with this Project Agreement, including with respect to noise, dust control, access to the Lands and the particular requirements in respect of those portions of the Works which are to be carried out within the Existing Infrastructure and in respect of those portions of the Works where connections are being made to the Existing Infrastructure;
 - (B) the construction, operations or maintenance activities of Contracting Authority, any Province Person, any Governmental Authority, any Other Contractor, any Railway Company, any Utility Company, the Municipality, any Municipal Transit System, and with respect to any road or roadway, including the performance of the Governmental Activities and the Other Works;
 - (C) the convenience of the public in respect of, and the access of the public to and use of, any public or private roads or highways or other transportation infrastructure including the Existing Infrastructure (other than the New Metrolinx Infrastructure and the New Third Party Infrastructure), whether under the control or in the possession of Contracting Authority or any other person, and Project Co shall minimize any lane closures or diversions, track closures or diversions, and traffic diversions or restrictions.
- (d) To the extent that the Project necessitates interference, in any way, with the operation of the existing transit systems or Existing Infrastructure, including the imposition of any closures or

detours on the existing transit systems or Existing Infrastructure, Project Co shall use commercially reasonable efforts to cooperate with Contracting Authority, Province Persons, Governmental Authorities, Other Contractors, Railway Companies, Utility Companies, the Municipality, Municipal Transit Systems, and other relevant third parties to ensure the continued operation of the existing transit systems, Existing Infrastructure and the rail systems.

- (e) Project Co shall develop and implement protocols in furtherance of its obligations as set out in this Section 11.19 in accordance with the Access Management Plan and the Output Specifications.

11.20 Substitutions

- (a) Whenever equipment, components, materials, supplies, tools, and other items are specified or otherwise described in this Project Agreement by using the name or catalogue or model number of a particular manufacturer, fabricator, vendor or distributor, or any other material name or description, the naming or identification of the item is intended to establish the type and the minimum function and quality required, and equipment, components, materials, supplies, tools, and other items of other manufacturers, fabricators, vendors or distributors shall not be substituted without the prior written consent of Contracting Authority, in its sole discretion.

11.21 Change in Standards

- (a) Where this Project Agreement requires Project Co to comply with a technical standard in respect of the design and construction of the New Metrolinx Infrastructure and the New Third Party Infrastructure, and that standard has changed between the date of this Project Agreement and the date that such compliance is required, then Project Co shall give Notice to Contracting Authority of such change. If, after such Notice, Contracting Authority requires compliance with the changed standard (rather than the standard applicable as of the date of this Project Agreement), then, to the extent such change impacts the Works and would not have otherwise been taken into account by compliance with Good Industry Practice, such changed standard shall, subject to and in accordance with Schedule 22 – Variation Procedure, result in a Variation. If Contracting Authority does not require compliance with the changed standard, then Project Co shall continue to comply with the standard applicable as of the date of this Project Agreement, without a Variation therefor. This Section 11.21 shall not apply where a change in a technical standard is also a Change in Law.

11.22 Subcontractors and Suppliers

- (a) Project Co shall preserve and protect the rights of the Parties under this Project Agreement with respect to the works to be performed under Subcontract, and shall:
 - (i) enter into Subcontracts or written agreements with Project Co Parties to require them to perform their work as provided in the Project Agreement;
 - (ii) incorporate the relevant terms and conditions of the Project Agreement into all contracts or written agreements with Project Co Parties; and
 - (iii) be as fully responsible to Contracting Authority for acts and omissions of the Project Co Parties as for acts and omissions of persons directly employed by Project Co.

- (b) Attached in Part 1 of Schedule 8 – Project Co Parties is a list of all Project Co Parties that Project Co has engaged or caused to be engaged for the performance of the Work as of the date of execution of this Project Agreement. Project Co agrees to update such list from time to time as additional Project Co Parties are engaged. Any of these named Project Co Parties listed by Project Co may be changed by Project Co upon prior Notice to (but without the approval of) the Contracting Authority Representative, provided however, that if the Contracting Authority Representative reasonably objects to any change to a Prequalified Subcontractor that is a Project Co Party, then Project Co shall select an alternative replacement Prequalified Subcontractor to which the Contracting Authority Representative does not reasonably object.
- (c) Project Co hereby agrees to contractually obligate the Construction Contractor to enter into the Construction Contractor’s Direct Agreement and, subject to Section 11.22(d), to cause the Construction Contractor to cause each of the other Project Co Parties, including Suppliers leasing any construction machinery and equipment, to enter into the Subcontractor’s Direct Agreement, to evidence, among other things, that Contracting Authority shall have the right to cure any default by the Construction Contractor under the Subcontract.
- (d) With the exception of the Subcontracts specifically listed in items 1 through 5 in Part 2 of Schedule 8 – Project Co Parties, none of Project Co, the Construction Contractor or the applicable Project Co Party are obliged to enter into a Subcontractor’s Direct Agreement in respect of Subcontracts having a total estimated cost of \$[REDACTED] or less.
- (e) Subject to Section 11.22(d), Project Co agrees to deliver to Contracting Authority the Subcontractor’s Direct Agreements by the applicable due dates set out in Part 2 of Schedule 8 – Project Co Parties. If, following the date that 100% Construction Document Submittals are submitted to Contracting Authority in accordance with Schedule 10 – Review Procedure, Project Co is required to enter into any additional Subcontractor’s Direct Agreement pursuant to this Section 11.22, Project Co shall deliver such Subcontractor’s Direct Agreements to Contracting Authority within 30 days after execution.

11.23 Apprenticeship Plan and Program

- (a) No later than 90 days after Financial Close, Project Co shall provide a plan setting out Project Co’s Project-specific approach to promoting apprenticeship training opportunities in connection with the completion of the Works on the Project (the “**Apprenticeship Plan**”) for review and approval by Contracting Authority. The Apprenticeship Plan shall include,
 - (i) specific objectives and methods for training and apprenticeship opportunities for the Project on a trade-by-trade basis;
 - (ii) apprenticeship opportunities for each trade required on the Project;
 - (iii) the number of apprentices to be employed for the Works, shall be in accordance with journeyman to apprentice ratios established in section 60 of the *Ontario College of Trades and Apprenticeships Act, 2009, S.O. 2009, c. 22*, as amended from time to time;
 - (iv) a confirmation that apprenticeships will be registered with the Ministry of Training, Colleges and Universities and the Ontario College of Trades, as applicable;

- (v) a program to ensure the required supply of apprentices to meet Project Co's Apprenticeship Plan targets and requirements;
 - (vi) a program to support apprentices on the Project, to complete their apprenticeships prior to Substantial Completion and, for those whose apprenticeships are not complete by the Substantial Completion Date a program to support apprentices, on a commercially reasonable basis, to complete their apprenticeships after the Substantial Completion Date; and
 - (vii) a focused apprenticeship program for at-risk youth, historically disadvantaged groups including low-income, racialized and immigrant populations, women, aboriginal persons, newcomers to Ontario, veterans, persons with disabilities, and residents of the community(ies) in which the Project is located.
- (b) Project Co shall implement the approved Apprenticeship Plan.
- (c) Project Co shall provide an annual report to Contracting Authority on the implementation of the Apprenticeship Plan which report shall include,
- (i) statistics on the number of apprentices involved in the Project relative to the number of journeymen, for each month of the Project; and
 - (ii) detailed information setting out Project Co's progress toward achieving the objectives set out in the Apprenticeship Plan, including an identification of barriers that prevented Project Co from achieving its objectives.
- (d) Contracting Authority may require Project Co to amend its Apprenticeship Plan if, in its opinion, acting reasonably, Project Co is failing to maximize apprenticeship opportunities on the Project pursuant to the then current Apprenticeship Plan.
- (e) Contracting Authority may, in its sole discretion, release Project Co's Apprenticeship Plan to the public. Project Co's Apprenticeship Plan shall not be Confidential Information.

11.24 Intentionally Deleted

11.25 COR Certification

- (a) Project Co shall, at its own cost and risk, at all times during the performance of the Works cause a COR-Qualified Construction Project Co Party or COR-Certified Construction Project Co Party, as the case may be, to:
- (i) to the extent a COR-Qualified Construction Project Co Party has not obtained COR Certification prior to Financial Close,
 - (A) use best efforts to obtain its COR Certification no later than 18 months following Financial Close. In the event that Contracting Authority is satisfied, in its sole discretion, that the COR-Qualified Construction Project Co Party has used best efforts to obtain its COR Certification in accordance with this Section 11.25 and the COR-Qualified Construction Project Co Party has not obtained COR

- Certification by the end of such 18-month period, then Contracting Authority shall establish a time period during which the COR-Qualified Construction Project Co Party shall obtain its COR Certification which time period shall not be less than 30 days, and
- (B) maintain in good standing and, as applicable, renew its OHSAS 18001 Accreditation until such time as the COR-Qualified Construction Project Co Party has obtained its COR Certification, and
 - (ii) once the COR-Qualified Construction Project Co Party is certified (hereafter referred to as a **“COR-Certified Construction Project Co Party”**), maintain in good standing, and, as applicable, renew its COR Certification; and
 - (iii) comply with all requirements of its OHSAS 18001 Accreditation (if a COR-Qualified Construction Project Co Party) or COR Certification (if a COR-Certified Construction Project Co Party), in accordance with its terms.
- (b) Without limiting any other provision of this Project Agreement, if at any time during the performance of the Works:
- (i) a COR-Qualified Construction Project Co Party fails to obtain its COR Certification in accordance with this Project Agreement and Contracting Authority determines that the failure to obtain the COR Certification is as a result of such COR-Qualified Construction Project Co Party not using best efforts to obtain such certification and Contracting Authority delivers a Notice to Project Co indicating that a COR-Qualified Construction Project Co Party has failed to obtain its COR Certification in accordance with this Project Agreement;
 - (ii) a COR-Qualified Construction Project Co Party fails to maintain its OHSAS 18001 Accreditation in good standing in accordance with its terms or in accordance with this Project Agreement; or
 - (iii) a COR-Certified Construction Project Co Party fails to maintain its COR Certification in good standing in accordance with its terms or in accordance with this Project Agreement,
(each a **“H&S Certification Default Event”**);
 - (iv) Contracting Authority delivers a Notice to Project Co indicating that Contracting Authority is of the opinion that a COR-Qualified Construction Project Co Party will fail to maintain its OHSAS 18001 Accreditation in good standing in accordance with its terms or in accordance with this Project Agreement; or
 - (v) Contracting Authority delivers a Notice to Project Co indicating that Contracting Authority is of the opinion that a COR-Certified Construction Project Co Party will fail to maintain its COR Certification in good standing in accordance with its terms or in accordance with this Project Agreement,

Project Co shall:

- (vi) immediately upon the occurrence of a H&S Certification Default Event, notify Contracting Authority that a H&S Certification Default Event has occurred, and:
 - (A) produce and deliver to Contracting Authority a report identifying the reasons for the failure to obtain or maintain in good standing the COR Certification or OHSAS 18001 Accreditation, as the case may be;
 - (B) produce and deliver to Contracting Authority a plan showing the steps that are to be taken to have the COR Certification or OHSAS 18001 Accreditation, as the case may be, obtained or reinstated in good standing within a period of not more than 30 days (the “**H&S Certification Reinstatement Plan**”), which H&S Certification Reinstatement Plan shall be subject to review and approval by Contracting Authority and, to the extent Contracting Authority requires any amendments or revisions to be made to the H&S Certification Reinstatement Plan, Project Co shall take, and shall cause the COR-Qualified Construction Project Co Party or the COR-Certified Construction Project Co Party, as the case may be, to take, all reasonable steps as may be necessary to make all such required amendments and revisions and deliver to Contracting Authority an amended H&S Certification Reinstatement Plan not more than five Business Days from the date on which such request is made by Contracting Authority;
 - (C) no later than five Business Days after the H&S Certification Default Event occurs, arrange to have conducted a complete H&S Construction Inspection in accordance with Section 15.1(b); and
 - (D) arrange to have conducted an H&S Construction Re-Inspection in accordance with Section 15.1(e), if required; or
- (vii) within five Business Days after receipt of the Notice from Contracting Authority under Section 11.25(b)(iv) or Section 11.25(b)(v):
 - (A) produce and deliver to the Contracting Authority Representative a report identifying the manner in which the COR Certification or OHSAS 18001 Accreditation, as the case may be, shall be maintained in good standing or obtained, as applicable;
 - (B) produce and deliver to the Contracting Authority Representative a plan showing the steps that are to be taken to ensure that the COR Certification or OHSAS 18001 Accreditation, as the case may be, will be maintained in good standing without interruption (the “**H&S Certification Maintenance Plan**”), which H&S Certification Maintenance Plan shall be subject to review and approval by Contracting Authority and, to the extent Contracting Authority requires any amendments or revisions to be made to the H&S Certification Maintenance Plan, Project Co shall take all reasonable steps as may be necessary to make all such required amendments and revisions and deliver to Contracting Authority an amended and H&S Certification Maintenance Plan not more than five Business Days from the date on which such request is made by Contracting Authority;

- (C) arrange to have conducted a complete H&S Construction Inspection in accordance with Section 15.1(b), and
- (D) arrange to have conducted an H&S Construction Re-Inspection in accordance with Section 15.1(e), if required.

11.26 Demolition Requirements

- (a) Without limiting Project Co's obligation to perform the Works at all times in accordance with Applicable Law, in respect of any Demolition, Project Co shall, and shall cause each applicable Project Co Party that is performing any part of the Demolition to, at such person's own cost and risk and at all times during the performance of the Works:
 - (i) conduct all work in connection with any Demolition at all times in compliance with section 3 of the Performance Standards Regulation and the Building Code;
 - (ii) ensure that all Project Co Parties having responsibility for the supervision of any such Demolition are qualified as either a professional engineer, limited license holder or provisional license holder (as such terms are used in the Performance Standards Regulation) (such person is hereinafter referred to as a "**Demolition Supervisor**");
 - (iii) observe and perform the Demolition in a manner that is consistent with the recommendations set forth in the Demolition Guidelines in all material respects; and
 - (iv) in respect of any Complex Structure Demolition to be conducted by Project Co or any applicable Project Co Party:
 - (A) prepare detailed specifications relating to such Complex Structure Demolition which specifications will include a detailed risk assessment and risk mitigation plan assessing all apparent or inferable risks that might be associated with the Demolition, colour-coded Load-Path Diagrams (which will include a description of the Demolition Requirements set forth herein) to supplement the Site work plans and blueprints relating to the Demolition and all other technical requirements relating to the Complex Structure Demolition (the "**Demolition Specifications**");
 - (B) at all times when a Complex Structure Demolition is being performed that the Demolition Specifications, Demolition work plans and Load-Path Diagram, be present and available at the Site at which such Complex Structure Demolition is being performed; and
 - (C) ensure at all times when a Complex Structure Demolition is being performed that a Demolition Supervisor will be on the Site at which such Complex Structure Demolition is being performed and actively supervising all activities in respect of the Complex Structure Demolition,
- (collectively the "**Demolition Requirements**").

- (b) If at any time while any Demolition is being performed pursuant to this Project Agreement, Project Co or any Project Co Party that is performing any part of any Demolition receives Notice from Contracting Authority or any Province Person or Governmental Authority that the Demolition is being conducted in a manner that is either not in compliance with the Demolition Requirements or not otherwise in accordance with this Project Agreement (such event referred to as a “**Demolition Default Event**”), Project Co shall and shall cause any applicable Project Co Party to:
- (i) be required immediately upon the occurrence of a Demolition Default Event, notify Contracting Authority that a Demolition Default Event has occurred, unless Contracting Authority was the person that provided Notice of the Demolition Default Event;
 - (ii) cease all work in respect of such Demolition; and
 - (iii) within five Business Days after receipt of a Notice of a Demolition Default Event produce and deliver to the Contracting Authority Representative:
 - (A) a report identifying the reasons for the occurrence of the Demolition Default Event; and
 - (B) a Demolition Plan showing the steps that are to be taken to rectify the Demolition Default Event within a period of not more than 30 days from the occurrence of the Demolition Default Event, which Demolition Plan shall be subject to review and approval by Contracting Authority and, to the extent Contracting Authority requires any amendments or revisions to be made to such Demolition Plan, Project Co and the applicable Project Co Parties shall take all reasonable steps as may be necessary to make all such required amendments and revisions and deliver to Contracting Authority an amended and revised Demolition Plan not more than five Business Days from the date on which such request is made by Contracting Authority.
- (c) No Demolition shall be recommenced at the Site that was the subject of the Demolition Default Event until:
- (i) Contracting Authority is satisfied that Project Co or the applicable Project Co Party has taken all necessary steps to remediate such Demolition Default Event in accordance with Demolition Plan; and
 - (ii) Contracting Authority has received a report, in form and substance satisfactory to Contracting Authority, prepared by a professional engineer that the Demolition Default Event has been remediated and the Site has been properly prepared for the Demolition to proceed in accordance with the Demolition Plan.
- (d) For clarity, Project Co shall not be eligible for a Delay Event or a Compensation Event in connection with a Demolition Default Event or the recommencement of a Demolition pursuant to Section 11.26(c).

11.27 Liquidated Damages and Construction Enforcement Regime

- (a) Project Co shall comply with Schedule 21 – Liquidated Damages and Construction Enforcement Regime, and shall be liable to Contracting Authority for all liquidated damages and Construction Period Deductions in accordance with the terms of Schedule 21 – Liquidated Damages and Construction Enforcement Regime and this Project Agreement.

11.28 Works, Goods, Equipment, Consumables and Materials

- (a) Project Co shall cause the Works, including the goods, equipment, consumables and materials used or supplied by it or any contractor or Subcontractor in connection with the Works to be:
 - (i) of good quality, fit for their intended purpose and maintained in a safe, serviceable and clean condition in accordance with the Output Specifications and Good Industry Practice;
 - (ii) of the type specified in the Output Specifications, if applicable; and
 - (iii) in compliance with all Applicable Law,

and shall, as soon as practicable after receiving a request from the Contracting Authority Representative, supply to the Contracting Authority Representative evidence to demonstrate its compliance with this Section 11.28(a).

- (b) Project Co shall cause sufficient stocks of goods, equipment, consumables and materials to be held in compliance with its obligations under this Project Agreement.

11.29 GO Passenger Charter

- (a) Project Co shall, and shall ensure that all Project Co Parties, carry out the Works in a manner that is in compliance with the GO Passenger Charter.
- (b) Project Co shall not, and Project Co shall ensure that the Project Co Parties do not, in any way whatsoever, contravene or cause Metrolinx to contravene the GO Passenger Charter.

11.30 Tracking System

- (a) Project Co shall, at its own cost and risk, provide to Contracting Authority a system to track (I) the status of each Listed Project Co PLAA through every stage of preparation, submission and approval, and (II) the progress made by the Category 1 Utility Companies in performing each part of the Category 1 Utility Work in accordance with the requirements and assumptions set out in the applicable Final Utility Baseline Document (including, for clarity, the durations set out in the Final Utility Baseline Document for the Category 1 Utility Work). For purposes of the tracking system relating to Category 1 Utility Work, each part of Category 1 Utility Work includes each individual scope of work identified under the heading “Category 1 Utility Baseline Document” in the Final Utility Baseline Document. More specifically, such system shall:
 - (i) be updated by Project Co each Business Day and be available to Contracting Authority (and with respect to the status of each Listed Project Co PLAA, the Municipality and TTC, as applicable) in real time each Business Day through a web-based interface which would

- include functionality to provide automated email alerts to a customizable frequency and set of email addresses;
- (ii) be operational no later than the date upon which the first Listed Project Co PLAA application is submitted or Category 1 Utility Work is commenced;
 - (iii) include a feature that highlights to Contracting Authority, the Municipality and the TTC, as applicable, each outstanding applicable Listed Project Co PLAA when it reaches the following milestone triggers:
 - (A) 75% of the number of Business Days designated for a final determination by the Municipality and/or TTC, as applicable, in Appendix C to Schedule 1 – Definitions and Interpretation for the applicable Listed Project Co PLAA;
 - (B) 100% of the number of Business Days designated for a final determination by the Municipality and/or TTC, as applicable, in Appendix C to Schedule 1 – Definitions and Interpretation for the applicable Listed Project Co PLAA; and
 - (C) five Business Days prior to the expiration of each applicable Listed Project Co PLAA Deadline; and
 - (iv) include a feature that highlights to Contracting Authority and the applicable Category 1 Utility Company each outstanding applicable part of Category 1 Utility Work when it reaches the following milestone triggers:
 - (A) 75% of the number of Business Days designated for completion by the Category 1 Utility Company in the applicable Final Utility Baseline Document for the applicable part of Category 1 Utility Work; and
 - (B) 100% of the number of Business Days designated for completion by the Category 1 Utility Company in the applicable Final Utility Baseline Document for the applicable part of Category 1 Utility Work.
- (b) Project Co shall submit documentation on the proposed design, functionality, and usage of the system to the Contracting Authority Representative in accordance with Schedule 10 – Review Procedure no later than 60 days after Financial Close.
 - (c) In addition, Project Co shall provide written notice to Contracting Authority Representative with respect to any outstanding Listed Project Co PLAA and with respect to any outstanding portion of Category 1 Utility Work when it reaches the milestone triggers outlined in Section 11.30(a)(iii) and Section 11.30(a)(iv) above.
 - (d) With respect to any failure to issue to Project Co a final determination in respect of a Listed Project Co PLAA prior to the expiration of the relevant Listed Project Co PLAA Deadline, Project Co shall not be entitled to the Delay Event or Compensation Event pursuant to Section 32.1(a)(xviii) unless the tracking system as described in Section 11.30(a) is fully functional and available to Contracting Authority and the Municipality and contains accurate information as to the status of the applicable Listed Project Co PLAA.

- (e) With respect to any failure to issue to Project Co a final determination in respect of a Listed Project Co PLAA prior to the expiration of the relevant Listed Project Co PLAA Deadline, Project Co shall not be entitled to the Delay Event or Compensation Event pursuant to Section 32.1(a)(xix) unless the tracking system as described in Section 11.30(a) is fully functional and available to Contracting Authority and TTC and contains accurate information as to the status of the applicable Listed Project Co PLAA.
- (f) With respect to any failure by a Category 1 Utility Company to perform any part of the Category 1 Utility Works, Project Co shall not be entitled to the Delay Event or Compensation Event pursuant to Section 32.1(a)(xiv) unless the tracking system as described in Section 11.30(a) is fully functional and available to Contracting Authority and contains accurate information as to the progress made by the Category 1 Utility Companies in performing each portion of the Category 1 Utility Work.

12. REPRESENTATIVES

12.1 The Contracting Authority Representative

- (a) Subject to the limitations set out in Section 12.1(d), the Contracting Authority Representative shall exercise the functions and powers identified in this Project Agreement as functions or powers to be performed by the Contracting Authority Representative and such other functions and powers of Contracting Authority under this Project Agreement as Contracting Authority may notify Project Co from time to time.
- (b) Contracting Authority may, from time to time by written Notice to Project Co, change the Contracting Authority Representative. Such change shall have effect on the later of the date of delivery of such Notice and the date specified in such Notice.
- (c) During any period when no Contracting Authority Representative has been appointed, or when the Contracting Authority Representative is unable, through illness, incapacity or any other reason whatsoever, to perform the Contracting Authority Representative's functions under this Project Agreement, Contracting Authority shall perform or may, by written Notice to Project Co, promptly appoint an alternative Contracting Authority Representative to perform the functions which would otherwise be performed by the Contracting Authority Representative. Upon receipt of such written Notice, Project Co and the Project Co Representative shall be entitled to treat any act of such alternative Contracting Authority Representative which is permitted by this Project Agreement as being authorized by Contracting Authority, and Project Co and the Project Co Representative shall not be required to determine whether authority has in fact been given.
- (d) The Contracting Authority Representative shall not, except as otherwise provided in this Project Agreement, be entitled to modify or waive any provision of this Project Agreement or to authorize a Variation.
- (e) Subject to the limitations set out in Sections 12.1(a) and 12.1(d), unless otherwise notified in writing, Project Co and the Project Co Representative shall be entitled to treat any act of the Contracting Authority Representative which is explicitly authorized by this Project Agreement as being authorized by Contracting Authority, and Project Co and the Project Co Representative shall not be required to determine whether authority has in fact been given.

12.2 The Project Co Representative

- (a) Subject to the limitations set out in Section 12.2(d), the Project Co Representative shall have full authority to act on behalf of Project Co for all purposes of this Project Agreement.
- (b) Project Co may change the Project Co Representative with the prior written consent of Contracting Authority.
- (c) During any period when the Project Co Representative is unable, through illness, incapacity or any other reason whatsoever, to perform the Project Co Representative's functions under this Project Agreement, Project Co shall perform or may, by written Notice to Contracting Authority, promptly appoint an alternative Project Co Representative to perform the functions which would otherwise be performed by the Project Co Representative, provided that, Project Co must seek Contracting Authority's consent in accordance with Section 12.2(b) if such alternative Project Co Representative is in place for more than 180 days. Upon receipt of such written Notice, Contracting Authority and the Contracting Authority Representative shall be entitled to treat any act of such alternative Project Co Representative which is permitted by this Project Agreement as being authorized by Project Co, and Contracting Authority and the Contracting Authority Representative shall not be required to determine whether authority has in fact been given.
- (d) The Project Co Representative shall not, except as otherwise provided in this Project Agreement, be entitled to modify or waive any provision of this Project Agreement.
- (e) Subject to the limitations set out in Section 12.2(d), unless otherwise notified in writing, Contracting Authority and the Contracting Authority Representative shall be entitled to treat any act of the Project Co Representative which is explicitly authorized by this Project Agreement as being authorized by Project Co, and Contracting Authority and the Contracting Authority Representative shall not be required to determine whether authority has in fact been given.

12.3 Communications to Representatives

- (a) At the time that a Party appoints or changes the appointment of the Contracting Authority Representative or the Project Co Representative, as applicable, that Party shall also provide the other Party with contact information for delivery of communications to such representative. Communications to such representative shall not constitute Notices to the Party appointing such representative.

12.4 Key Individuals

- (a) The individuals who are critical to the performance of the Works are identified in Schedule 9 – Key Individuals. Project Co shall use commercially reasonable efforts to ensure that such persons remain involved in the Works in the capacity set out in Schedule 9 – Key Individuals (unless such Key Individuals are not available for reasons beyond the control of Project Co or a Project Co Party). Project Co or a Project Co Party shall not, for the duration of the Works, require or request any such person to be involved in any other project, if, in the reasonable opinion of Contracting Authority such involvement would have a material adverse effect on the Works. If Project Co fails to comply with this Section 12.4(a), Project Co shall pay to Contracting Authority liquidated damages as set out in Section 4.1(a) of Schedule 21 – Liquidated Damages and Construction Enforcement Regime. The Parties agree that the liquidated damages set out in Section 4.1(a) of

Schedule 21 – Liquidated Damages and Construction Enforcement Regime are not a penalty but represent a genuine and reasonable pre-estimate of the damages that Contracting Authority will suffer as a result of Project Co’s failure to provide the applicable Key Individual. For clarity, Project Co and the Project Co Parties’ reasonable commercial efforts, in accordance with this Section 12.4(a), shall include the denial of promotions or relocations of a Key Individual as permitted by the Applicable Law. For the purposes of this Section 12.4(a), only the following reasons will be considered beyond the control of Project Co or a Project Co Party: (i) death; (ii) short-term disability; (iii) long-term disability; (iv) maternity leave, parental leave or any other job protected leave under Applicable Law; (v) termination of employment for cause; (vi) retirement; or (vii) any other reason in the opinion of Contracting Authority, acting reasonably (Project Co shall provide to Contracting Authority any further documentation as may be reasonably requested by Contracting Authority to assess any reason beyond the control of Project Co).

- (b) Subject to Project Co’s obligations to ensure that Key Individuals remain involved in the Works as set out in Section 12.4(a), if it becomes necessary for Project Co to replace any individual identified in Schedule 9 – Key Individuals, Project Co shall nominate a competent suitably qualified and experienced permanent replacement or replacements as soon as practicable and provide Contracting Authority with relevant information on the proposed replacement and shall consult with Contracting Authority before finalizing the appointment of such replacement. Project Co shall not replace any of the individuals identified in Schedule 9 – Key Individuals without the prior written consent of Contracting Authority, which consent shall not be withheld or delayed where Project Co is compliant with Sections 12.4(a) and 12.4(c) and the proposed replacement is suitably qualified and experienced. In the event Project Co fails to nominate a competent suitably qualified and experienced permanent replacement or replacements for a period of greater than 120 days from the date it became necessary for Project Co to replace any individual identified in Schedule 9 – Key Individuals, Project Co shall pay to Contracting Authority liquidated damages as set out in Section 4.1(b) of Schedule 21 – Liquidated Damages and Construction Enforcement Regime. The Parties agree that the liquidated damages set out in Section 4.1(b) of Schedule 21 – Liquidated Damages and Construction Enforcement Regime are not a penalty but represent a genuine and reasonable pre-estimate of the damages that Contracting Authority will suffer as a result of Project Co’s failure to provide the applicable Key Individual.
- (c) If Contracting Authority determines, acting reasonably, that it is in the best interests of Contracting Authority that any individual identified in Schedule 9 – Key Individuals be replaced, Contracting Authority shall notify Project Co (including a detailed explanation of the reasons for such determination), and, within 30 days after receipt by Project Co of such Notice, Project Co shall provide Contracting Authority with relevant information on the proposed replacement and shall consult with Contracting Authority before finalizing the appointment of such replacement.

13. WORKS SCHEDULE REQUIREMENTS AND WORKS REPORT

13.1 Completion of the Works

- (a) Project Co shall complete the Works in accordance with this Project Agreement and achieve:
 - (i) Interim Completion by the Scheduled Interim Completion Date;
 - (ii) Substantial Completion by the Scheduled Substantial Completion Date; and

- (iii) Final Completion by the Scheduled Final Completion Date.

13.2 Works Schedule Requirements

- (a) Project Co and Contracting Authority shall comply with the provisions of Schedule 12 – Works Schedule Requirements.

13.3 Intentionally Deleted

13.4 Notification of Early Interim Completion

- (a) Unless Project Co obtains the prior written consent of Contracting Authority, in Contracting Authority's sole discretion, Project Co shall not be entitled to the Interim Completion Certificate prior to, and the Interim Completion Date shall not be earlier than, the Scheduled Interim Completion Date.
- (b) If Project Co advises Contracting Authority that Project Co expects to be able to achieve Interim Completion prior to the Scheduled Interim Completion Date, the Contracting Authority Representative shall be entitled to require Project Co to produce and submit to the Contracting Authority Representative a revised Progress Works Schedule (or Recovery Works Schedule, as applicable) showing the manner and the periods in which the Interim Completion Works shall be performed and what the revised date for Interim Completion would be so as to enable Contracting Authority to consider at its sole discretion:
 - (i) whether to agree to an earlier Scheduled Interim Completion Date; and
 - (ii) what modifications, if any, shall be required to this Project Agreement in order to accommodate such earlier Scheduled Interim Completion Date.

All costs associated with any such modifications to this Project Agreement shall be borne by Project Co.

13.5 Notification of Early Substantial Completion

- (a) Unless Project Co obtains the prior written consent of Contracting Authority, in Contracting Authority's sole discretion, Project Co shall not be entitled to the Substantial Completion Certificate prior to, and the Substantial Completion Date and Substantial Completion Payment Date shall not be earlier than, the Scheduled Substantial Completion Date.
- (b) If Project Co advises Contracting Authority that Project Co expects to be able to achieve Substantial Completion prior to the Scheduled Substantial Completion Date, the Contracting Authority Representative shall be entitled to require Project Co to produce and submit to the Contracting Authority Representative a revised Progress Works Schedule (or Recovery Works Schedule, as applicable) showing the manner and the periods in which the Works shall be performed and what the revised date for Substantial Completion would be so as to enable Contracting Authority to consider at its sole discretion:
 - (i) whether to agree to an earlier Scheduled Substantial Completion Date; and

- (ii) what modifications, if any, shall be required to this Project Agreement in order to accommodate such earlier Scheduled Substantial Completion Date.

All costs associated with any such modifications to this Project Agreement shall be borne by Project Co.

13.6 Works Report

- (a) Project Co shall continuously monitor the progress of the Works in relation to the Baseline Works Schedule and, within 15 Business Days after the end of each calendar month from Financial Close until the Final Completion Date, Project Co shall provide to the Independent Certifier and submit to the Contracting Authority Representative in accordance with Schedule 10 – Review Procedure a works report (each, a “**Works Report**”), which will include:

- (i) an executive summary describing the general status of the Works and progress made over the relevant month;
- (ii) a table setting out and responding to items of Project Agreement non-compliance and deficiencies in ongoing Works as identified by Contracting Authority and Project Co;
- (iii) a Progress Works Schedule, Basis of Works Schedule Report and Works Schedule Report all in accordance with Schedule 12 – Works Schedule Requirements;
- (iv) a narrative description of any Disputes related to the Works, including any action that has taken place over the relevant month to resolve such Disputes;
- (v) a narrative description of the status of any Proceeding at Risk Matter that has not been resolved pursuant to Section 14.6(f), in accordance with Schedule 27 – Dispute Resolution Procedure or otherwise;
- (vi) an update on those matters set out in Schedule 33 – Works Report Requirements;
- (vii) the information described in Section 4.21(c);
- (viii) a detailed, narrative description of all issues relating to Warranty Work and warranties set out in Sections 11.16 and 11.17; and
- (ix) any other information specifically requested by Contracting Authority on the progress of the Works,

all in form and substance satisfactory to Contracting Authority, acting reasonably. For greater certainty, for all updates and revisions to any of the Project Works Schedules, Project Co must provide a revised critical path reflecting the updated or revised Project Works Schedule.

- (b) Project Co shall use, and shall ensure that the Construction Contractor uses, the contract management software system specified by Contracting Authority.

14. WORKS COMMITTEE

14.1 Establishment

- (a) The Parties shall, within 30 days after Financial Close, establish a committee (the “**Works Committee**”) consisting of:
 - (i) four representatives appointed by Contracting Authority from time to time, one of whom shall be the Contracting Authority Representative; and
 - (ii) three representatives appointed by Project Co, one of whom shall be the Project Co Representative, and one of whom shall be a representative of the Construction Contractor.
- (b) The Independent Certifier and the Design Compliance Consultant shall be entitled, but not required, to attend meetings as non-voting members of the Works Committee. Members of the Works Committee may invite, on prior Notice to all members, such advisors and consultants as they require from time to time to attend meetings and to provide briefings to the Works Committee members.
- (c) The Contracting Authority Representative shall be the chairperson of the Works Committee.

14.2 Function and Role

- (a) The Works Committee shall assist the Parties by promoting cooperative and effective communication with respect to matters related to the Works.
- (b) The Works Committee shall be responsible for receiving and reviewing all matters related to the Works, including:
 - (i) any design, construction and commissioning issues;
 - (ii) the Project Works Schedules, the Basis of Works Schedule Reports and the Works Schedule Reports;
 - (iii) any issues arising from reports or documents provided by Project Co or the Independent Certifier;
 - (iv) any quality assurance and safety and security issues, including any design, configuration control, interfacing, training, testing, operational impact and other matters creating or giving rise to a safety or security issue or otherwise requiring attention and oversight;
 - (v) the Works Reports;
 - (vi) any special matters referred to the Works Committee by Contracting Authority or Project Co;
 - (vii) any Proceeding at Risk Matters referred to the Works Committee in accordance with Section 14.6;

- (viii) any community and media relations issues in accordance with Schedule 18 – Communication and Public Engagement Protocol;
 - (ix) any issues related to the Access Management Plan and any issues related to the rules, requirements and restrictions relating to access, rail safety and operations and track protection, all as set out in Schedule 15 – Output Specifications and Schedule 34 – Rail Corridor Access and Flagging;
 - (x) monitoring the Interim Completion Commissioning Program and the Final Commissioning Program; and
 - (xi) any other issues pertaining to the Works.
- (c) Subject to Section 14.2(d), any unanimous decision of the Works Committee shall be final and binding on the Parties. If the Works Committee is unable to reach a unanimous decision, either Party may refer the matter for resolution in accordance with Schedule 27 – Dispute Resolution Procedure.
- (d) The Works Committee shall not have authority to make decisions with respect to or approve:
- (i) any amendment to or waiver of any provision of this Project Agreement;
 - (ii) any change to a major milestone date set out in the any Project Works Schedule, the Scheduled Interim Completion Date, the Scheduled Substantial Completion Date or the Scheduled Final Completion Date;
 - (iii) any Variation;
 - (iv) any change that may materially adversely affect Project Co’s ability to achieve Interim Completion by the Scheduled Interim Completion Date, Substantial Completion by the Scheduled Substantial Completion Date or Final Completion by the Scheduled Final Completion Date; or
 - (v) any matter with respect to which Contracting Authority has a right of consent or in respect of which Contracting Authority may exercise discretion pursuant to this Project Agreement.

14.3 Term of Works Committee

- (a) Unless otherwise agreed by the Parties, the Works Committee shall operate only until the Final Completion Date.

14.4 Replacement of Committee Members

- (a) Contracting Authority shall be entitled to replace any of its respective representatives on the Works Committee by written Notice to Project Co. Contracting Authority will use commercially reasonable efforts to deliver prior written Notice of any such replacement to Project Co. Project Co may replace any of its representatives on the Works Committee with the prior written consent of Contracting Authority.

14.5 Procedures and Practices

- (a) The members of the Works Committee may:
- (i) adopt such procedures and practices for the conduct of the activities of the Works Committee as they consider appropriate from time to time;
 - (ii) invite to any meeting of the Works Committee such other persons as the members of the Works Committee may agree;
 - (iii) exclude from any meeting of the Works Committee such persons as the members of the Works Committee may agree; and
 - (iv) receive and review reports from any person or organization agreed to by the members of the Works Committee.
- (b) Once established, the Works Committee shall meet at least once each month from Financial Close until the Final Completion Date, unless otherwise agreed by the members of the Works Committee or the Parties.
- (c) Any one of the Project Co Representatives or the Contracting Authority Representatives on the Works Committee may convene a special meeting of the Works Committee at any time. Special meetings of the Works Committee may be convened on not less than five Business Days' Notice to all members of the Works Committee identifying the agenda items to be discussed at the special meeting, provided that, in an Emergency, a meeting may be called at any time on such Notice as may be reasonable in the circumstances.
- (d) Unless otherwise agreed by the members of the Works Committee, the Works Committee shall meet in the City of Toronto, Ontario. Meetings of the Works Committee may be held by means of such telephonic, electronic or other communication facilities as permit all persons participating in the meeting to communicate with each other simultaneously and instantaneously. A person participating in a meeting by such means will be deemed to be present at such meeting, provided that each member of the Works Committee must attend in person at least once each calendar quarter.
- (e) Three representatives appointed by Contracting Authority (one of whom shall be the Contracting Authority Representative) and two representatives appointed by Project Co (one of whom shall be the Project Co Representative) shall constitute a quorum at any meeting of the Works Committee. A quorum of members may exercise all the powers of the Works Committee. The members shall not transact business at a meeting of the Works Committee unless a quorum is present.
- (f) Minutes of all meetings, recommendations and decisions of the Works Committee, including those made by telephone or other form of communication, shall be recorded and maintained by Project Co. Project Co shall circulate copies of such minutes within five Business Days after the holding of the meeting or the making of the recommendation or decision. Unless Contracting Authority notifies Project Co within five Business Days after receipt of the minutes that Contracting Authority disagrees with the contents of the minutes, Project Co and Contracting Authority shall be deemed to have approved such minutes. Project Co shall maintain a complete set of all minutes

of the meetings of the Works Committee and shall make such minutes available for inspection by Contracting Authority during regular business hours.

14.6 Proceeding at Risk

- (a) If at any time:
- (i) in the reasonable opinion of Contracting Authority, Project Co is performing the Works in a manner that may result in Project Co becoming unable to satisfy the requirements for Interim Completion or Substantial Completion; or
 - (ii) the Contracting Authority Representative has noted a Works Submittal as “CRITICAL NON-CONFORMANCE” in accordance with Schedule 10 – Review Procedure,

(each of the matters described in Sections 14.6(a)(i) and 14.6(a)(ii) a “**Proceeding at Risk Matter**”), then Contracting Authority may issue to Project Co (with a copy to the Independent Certifier) a Notice (the “**Proceeding at Risk Notice**”) identifying Contracting Authority’s reasons for issuing the Proceeding at Risk Notice and requesting Project Co to deliver any relevant Design Data and any other information reasonably required by Contracting Authority from Project Co to review the Proceeding at Risk Matter.

- (b) Following the issuance of a Proceeding at Risk Notice, the Contracting Authority Representative and the Project Co Representative, together with the other members of the Works Committee, shall each promptly and diligently make a reasonable *bona fide* effort to resolve the Proceeding at Risk Matter. The Independent Certifier shall be required to attend all meetings and deliberations of the Works Committee at which the Proceeding at Risk Matter is considered, but shall not be entitled to participate in any decisions of the Works Committee.
- (c) Within 10 Business Days after receipt by Project Co of a Proceeding at Risk Notice, Project Co shall deliver a response to Contracting Authority, each member of the Works Committee and the Independent Certifier, which shall include:
- (i) the Design Data and any other information requested by Contracting Authority in the Proceeding at Risk Notice;
 - (ii) Project Co’s opinion confirming agreement with, or disputing the opinion of, Contracting Authority regarding the Proceeding at Risk Matter;
 - (iii) any additional Design Data and other information in support of Project Co’s opinion regarding the Proceeding at Risk Matter;
 - (iv) Project Co’s proposal to rectify the Proceeding at Risk Matter; and
 - (v) any reasonable request for additional information from Contracting Authority in respect of the Proceeding at Risk Matter.
- (d) Within five Business Days after receipt by Contracting Authority of the response from Project Co pursuant to Section 14.6(c), Contracting Authority shall notify Project Co if Contracting Authority requires any additional information from Project Co. Project Co shall provide such additional

information to Contracting Authority and each member of the Works Committee and the Independent Certifier within five Business Days after receipt of such Notice.

- (e) Within 15 Business Days after receipt by Contracting Authority of all deliverables contemplated by Section 14.6(c) and, if applicable, Section 14.6(d), and in any event, no later than 35 Business Days after receipt by Project Co of the Proceeding at Risk Notice, the Works Committee shall meet in person (the “**PAR Meeting**”) to attempt to resolve the Proceeding at Risk Matter.
- (f) Within five Business Days after the PAR Meeting and, in any event, no later than 40 Business Days after receipt by Project Co of the Proceeding at Risk Notice, the Works Committee shall attempt to reach a final decision with respect to the Proceeding at Risk Matter. If the Works Committee is unable to reach a final decision, the parties shall immediately refer the Proceeding at Risk Matter to the Independent Certified, who shall within 5 Business Days, or such longer time as reasonably agreed by the Parties, provide its written opinion and supporting analysis as to whether Project Co is Proceeding at Risk, including an opinion as to whether Project Co is performing the Works in a matter that will result in Project Co becoming unable to satisfy the requirements for Substantial Completion.
- (g) If the Independent Certifier determines pursuant to Section 14.6(f) that Project Co is Proceeding at Risk Notice, Contracting Authority may, in its sole discretion, give notice to the Lenders’ Agent pursuant to Section 13 of the Lenders’ Direct Agreement that Project Co is Proceeding at Risk, together with a copy of the Independent Certifier’s written opinion.
- (h) Following the Independent Certifier’s decision pursuant to Section 14.6(f), either Party may refer the Proceeding at Risk Matter for resolution in accordance with Schedule 27 – Dispute Resolution Procedure.
- (i) The Proceeding at Risk Notice, review, and comments made during the process set out in this Section 14.6 are for general conformity to the obligations and requirements of this Project Agreement, and any such Notice, review and comment shall not relieve Project Co of the risk and responsibility for the Works and for meeting all of its obligations under and satisfying all requirements of this Project Agreement, and shall not create any new or additional obligations or liabilities for Contracting Authority.

15. QUALITY MANAGEMENT

15.1 Quality Management

- (a) Project Co shall comply with the provisions of Schedule 11 – Quality Management.
- (b) Subject to Section 15.1(c), Project Co shall cause the Construction Contractor, at its sole cost and expense, to conduct an inspection of its facilities and of its health and safety management systems on an annual basis until Final Completion or as otherwise required in accordance with Sections 11.25(b)(vi)(C) or 11.25(b)(vii)(C) (each, an “**H&S Construction Inspection**”), which H&S Construction Inspections shall:
 - (i) be conducted by a Certified H&S Inspector, and

- (ii) during the performance of the Works, include, at a minimum,
 - (A) a review of general compliance with all applicable *Occupational Health and Safety Act* (Ontario) requirements, compliance with all safety manuals applicable to the Site at which the Works are being conducted including the Contractor Site Specific Safety Manual; and
 - (B) a review of the Construction Contractor’s job hazard analysis documentation on any portion of the Lands which could endanger or put at risk the safety of any person working on any portion of the Lands;
- (c) The first H&S Construction Inspection shall occur no later than the 90th day following Financial Close or, if that day is not a Business Day, on the Business Day immediately succeeding such day.
- (d) Project Co shall cause the results of each H&S Construction Inspection (such results referred to as the “**H&S Construction Inspection Report**”) to be delivered to Contracting Authority and the Works Committee not more than five Business Days from the date on which a H&S Construction Inspection is completed. An H&S Construction Inspection Report arising from an H&S Construction Inspection shall be tabled and presented by Project Co for discussion by the Works Committee at the next meeting of the Works Committee that follows the date on which such H&S Construction Inspection Report was issued.
- (e) To the extent an H&S Construction Inspection Report discloses any non-compliance by the COR-Qualified Construction Project Co Party or the COR-Certified Construction Project Co Party, as the case may be, with the terms of the COR Certification or OHSAS 18001 Accreditation, as the case may be, Contracting Authority shall have the right to require Project Co to cause the COR-Qualified Construction Project Co Party or the COR-Certified Construction Project Co Party, as the case may be, at its sole cost and expense:
 - (i) to take any corrective and remedial action required by the H&S Construction Inspection Report to correct any such non-compliance and Project Co shall cause the COR-Qualified Construction Project Co Party or the COR-Certified Construction Project Co Party, as the case may be, to comply with all instructions given by the Certified H&S Inspector in respect of actions required to be taken to correct any such non-compliance;
 - (ii) to arrange to have conducted by a Certified H&S Inspector such follow-up H&S Construction Inspections of those facilities and health management systems associated with the non-compliances identified in the relevant H&S Construction Inspection Report (each, an “**H&S Construction Re-Inspection**”) within three Business Days from the date on which any such request is made by Contracting Authority, until any and all corrective and remedial actions required by the Certified H&S Inspector with respect to the correction of each identified non-compliance is completed to the satisfaction of the Certified H&S Inspector; and
 - (iii) to cause the results of each H&S Construction Re-Inspection (such results referred to as the “**H&S Construction Re-Inspection Report**”) to be delivered to Contracting Authority and the Works Committee not more than three Business Days from the date on which a H&S Construction Re-Inspection is completed. An H&S Construction Re-Inspection Report arising from an H&S Construction Re-Inspection shall be tabled and

presented by Project Co for discussion by the Works Committee at the next meeting of the Works Committee that follows the date on which such H&S Construction Re-Inspection Report was issued.

16. ACCESS TO THE METROLINX LANDS

16.1 Access to Metrolinx Lands

- (a) Subject to this Section 16 and the provisions of Schedule 20 – Lands, including any restrictions on the use and access to the Metrolinx Lands set out Schedule 20 – Lands, Contracting Authority shall grant or have caused to be granted, and shall continuously grant or cause to be granted, to Project Co and all Project Co Parties non-exclusive licence rights of use and access to, on and over the Metrolinx Lands, except such rights set out as a Project Co responsibility to obtain under the Permits, Licences, Approvals and Agreements tables attached as Appendix A to Schedule 1 – Permits, Licences, Approvals and Agreements, as are required by Project Co and such Project Co Parties and sufficient (subject to Project Co performing its obligations described in the Permits, Licences, Approvals and Agreements tables attached as Appendix A to Schedule 1 – Permits, Licences, Approvals and Agreements and subject to the timing and extent of the grant of use and access to the Metrolinx Lands set out in Schedule 20 – Lands) to allow Project Co and such Project Co Parties to perform that part of the Works to be performed on Metrolinx Lands. The rights granted to Project Co pursuant to this Section 16.1(a) shall be effective on the later of,
- (i) the date of Financial Close; and
 - (ii) the commencement date for access to individual parcels of lands that comprise the Metrolinx Lands as set out in Schedule 20 – Lands.
- (b) Subject to Project Co’s obligation to comply with the other terms and conditions set forth in this Project Agreement and the other Project Documents, Project Co shall ensure that each Project Co Party shall at all times, when entering the Lands, act in a manner consistent with the obligations of Project Co under the Project Agreement.
- (c) In consideration for the use and access rights granted pursuant to Section 16.1(a), Project Co shall provide the Works subject to and in accordance with this Project Agreement.
- (d) Without derogating from any of Contracting Authority’s rights hereunder, in particular, its rights of access to the Metrolinx Lands prior to,
- (i) the Interim Completion Date for the purposes of any Interim Completion Contracting Authority Commissioning; and
 - (ii) the Substantial Completion Date for the purposes of any Contracting Authority Commissioning,

and subject to any restrictions set out in Schedule 20 – Lands, Contracting Authority acknowledges that, in respect of the Works, Project Co and the Project Co Parties require, and Contracting Authority shall provide, access to the Metrolinx Lands without material interference by Contracting Authority or any Province Person for such period of time identified in

- Section 16.1(a). Project Co further acknowledges that following Final Completion, Project Co's access to the Metrolinx Lands shall be subject to the Contracting Authority Activities.
- (e) Subject to Section 16.1(f), none of the rights granted pursuant to this Section 16.1 shall grant access to,
 - (i) any lands beyond the boundaries of the Metrolinx Lands, or to any lands other than the Metrolinx Lands, other than easements and similar interests of Contracting Authority which benefit the Metrolinx Lands, obtained after the date of this Project Agreement, to the extent the same are necessary for the Works or exceed any restrictions set out in Schedule 20 – Lands; or
 - (ii) any facilities or infrastructure of Contracting Authority, the Municipality, Utility Companies, Railway Companies or any other third parties, except as set out in Schedule 20 – Lands (which access, if any, is subject to Section 16.1(b)).
 - (f) Contracting Authority shall provide Project Co with limited access to the Existing Metrolinx Infrastructure, to the extent necessary to perform the Works and subject to such reasonable conditions as are imposed by Contracting Authority.
 - (g) The use and access rights provided in this Section 16.1 shall automatically terminate as of the Termination Date, save and except for any earlier termination of the use and access rights specified in Schedule 20 – Lands.
 - (h) For greater certainty, the use and access rights provided in this Section 16.1 shall not entitle Project Co or any Project Co Party to extract any mineral from the Metrolinx Lands for use in the Works.
 - (i) Contracting Authority shall acquire use of and access to the Metrolinx Lands described in Schedule 20 – Lands on or prior to the applicable commencement date for access set out in Schedule 20 – Lands. Contracting Authority shall provide Notice to Project Co of the commencement of access rights to the Metrolinx Lands as such access is obtained by Contracting Authority.

16.2 Non-Exclusive Rights to Metrolinx Lands and Development of Lands

- (a) Project Co acknowledges and agrees that the rights granted to Project Co and the Project Co Parties hereunder to the Metrolinx Lands shall be non-exclusive and that Contracting Authority and any person authorized by Contracting Authority may occupy and possess the Metrolinx Lands, the New Metrolinx Infrastructure, the New Third Party Infrastructure and the Existing Infrastructure (in each case, on the Metrolinx Lands) without the prior consent of Project Co, including for the purposes of carrying out the Governmental Activities and the Other Works. In exercising its rights Project Co shall not, and shall require that the Project Co Parties shall not, except as permitted under this Project Agreement, disrupt the performance of the Governmental Activities or the Other Works.
- (b) Without limiting Section 16.2(a) Project Co acknowledges that Contracting Authority may from time to time use or develop (including by way of subdivision or expansion), or permit the use or development of, or dispose of, portions of the Metrolinx Lands, other than those portions of the Metrolinx Lands (or interests in the Metrolinx Lands) necessary for the performance of the Works.

To the extent that such use, development or disposition materially adversely interferes with Project Co's licence rights hereunder or materially adversely interferes with Project Co's ability to perform the Works, such use, development or disposition shall, subject to and in accordance with Schedule 22 – Variation Procedure, result in a Variation. For greater certainty, but without limiting the generality of the foregoing, Project Co acknowledges and agrees that certain of the Metrolinx Lands shall be subject to the restrictions set out in Schedule 20 – Lands and Schedule 15 – Output Specifications.

- (c) Project Co shall be solely responsible to arrange all access to lands that it requires to access Existing Third Party Infrastructure except in the case of Existing Third Party Infrastructure located on the Metrolinx Lands, in which case, access to the Metrolinx Lands is provided for in accordance with Schedule 20 – Lands and any Permits, Licences, Approvals and Agreements. Project Co shall be solely responsible to obtain permission from the applicable third party to access the Existing Third Party Infrastructure or any component thereof owned by third parties.

16.3 Limited Access Areas

- (a) For purposes related to the provision of the Governmental Activities, Contracting Authority may limit or restrict Project Co's access to designated portions of the Metrolinx Lands, the New Metrolinx Infrastructure, the New Third Party Infrastructure or the Existing Infrastructure (in each case, on Metrolinx Lands), as set out in Schedule 15 – Output Specifications unless a person seeking access obtains the prior written consent of Contracting Authority, which consent may be subject to such reasonable conditions as are imposed by Contracting Authority.

16.4 Naming and Signage

- (a) Project Co acknowledges that Contracting Authority and the applicable owners of the New Third Party Infrastructure and the Existing Third Party Infrastructure reserve and retain,
 - (i) all rights to designate the name for the New Metrolinx Infrastructure, the New Third Party Infrastructure and the Existing Infrastructure, and any part thereof and to retain all revenues derived from the sponsorship of such names;
 - (ii) all rights to signage in relation to the Lands and any part of the New Metrolinx Infrastructure, the New Third Party Infrastructure and the Existing Infrastructure; and
 - (iii) all rights, Trade-Marks, naming or branding regarding any part of the New Metrolinx Infrastructure, the New Third Party Infrastructure and the Existing Infrastructure.
- (b) Without limiting Contracting Authority's rights pursuant to Section 16.4(a), with the prior written consent of Contracting Authority, which may take into consideration,
 - (i) any applicable governmental or other guidelines, including the guidelines set out in Schedule 15 – Output Specifications or Schedule 18 – Communication and Public Engagement Protocol; and
 - (ii) any provision or restriction set out in Schedule 20 – Lands,

Project Co, the Project Co Parties and the Senior Lenders may, for the period prior to Substantial Completion, erect and maintain signage which may include such parties' logos and trade names at or on the Metrolinx Lands identifying their respective roles in connection with the development and construction of the Project, provided that such signage is erected and maintained in accordance with the requirements and restrictions set out in this Project Agreement, including Schedule 15 – Output Specifications and Schedule 18 – Communication and Public Engagement Protocol.

16.5 No Interest in Land, Facilities or Infrastructure

- (a) Project Co acknowledges and agrees that neither Project Co nor the Lenders shall acquire any estate, right, title or ownership interest in the Lands or any part of the New Metrolinx Infrastructure, the New Third Party Infrastructure or the Existing Infrastructure, or any other interest in land, facilities or infrastructure pursuant to this Project Agreement, the Project Documents or otherwise. Notwithstanding any provision herein or in any of the Project Documents to the contrary, all fee simple interest in and freehold title to the Lands, or any part thereof, and the Project, shall at all times remain unencumbered by any interest of Project Co or the Lenders. Project Co and the Lenders shall have access to the Metrolinx Lands, the New Metrolinx Infrastructure, and the Existing Metrolinx Infrastructure under and subject to the licences and access rights granted under this Section 16 and the Lenders' Direct Agreement, respectively.

16.6 Non-Disturbance Agreement

- (a) If Contracting Authority mortgages, charges or otherwise encumbers the Metrolinx Lands, Contracting Authority shall notify Project Co and, at the request of Project Co, provide Project Co with an agreement, in form satisfactory to Project Co, acting reasonably, executed by the mortgagee, chargee or other encumbrancer of the Metrolinx Lands permitting Project Co and the Lenders' Agent to access and use the Metrolinx Lands under the use and access granted pursuant to this Section 16 and the Lenders' Direct Agreement, respectively, free from interference from the mortgagee, chargee or other encumbrancer or any person claiming by or through the mortgagee, chargee or other encumbrancer. This Section 16.6 shall not apply in respect of any portion of the Metrolinx Lands used or developed pursuant to Section 16.2(b) if neither the licence granted pursuant to this Section 16 nor the Works pertain to such portion of the Metrolinx Lands.

16.7 Adjustments to Metrolinx Lands Available to Project Co

- (a) Project Co may propose, to Contracting Authority, the acquisition of additional lands in order to improve the efficiency of Project Co's performance of the Works. Contracting Authority may, in its sole discretion, accept or reject any Project Co proposal to acquire additional lands. In the event that Contracting Authority agrees to Project Co's proposal on the acquisition of additional lands, such acquisition shall become part of the Metrolinx Lands once acquired and shall, subject to and in accordance with Schedule 22 – Variation Procedure, result in a Variation. Such additional lands shall not become part of the Metrolinx Lands and shall not be used in respect of the Works unless and until,
- (i) Contracting Authority has issued a Variation Confirmation pursuant to Schedule 22 – Variation Procedure; and
 - (ii) title to the additional lands has been successfully conveyed to Metrolinx.

- (b) Project Co acknowledges and agrees that any decision of Contracting Authority pursuant to Section 16.7(a) shall be final and binding on the Parties and in the event that Contracting Authority does not agree to an acquisition of additional lands pursuant to Section 16.7(a), Project Co acknowledges and agrees that Contracting Authority's decision shall not be subject to resolution pursuant to Schedule 27 – Dispute Resolution Procedure.
- (c) Project Co shall be entitled to obtain any properties (or obtain temporary access to any properties) at its own cost and expense, however, such properties shall not, for the purposes of this Project Agreement, form part of the Metrolinx Lands and no New Metrolinx Infrastructure shall be located on, or rely in any way upon, on any properties which Project Co acquires pursuant to this Section 16.7(c).

16.8 Changes to Lands

- (a) Notwithstanding any other provision in this Project Agreement, the Parties acknowledge and agree that any alteration, addition or variation to or in the Lands described in Schedule 20 – Lands or the dates by which Contracting Authority grants Project Co access to the Lands pursuant to Section 16.1(a) shall be effected by way of Variation, subject to and in accordance with Schedule 22 – Variation Procedure and as applicable, Section 16.7, and for greater clarity, shall not be treated as either a Delay Event or a Compensation Event.

17. ENCUMBRANCES

17.1 Project Co Shall Perform Obligations Under Encumbrances

- (a) Project Co's access to and use of the Lands or any part thereof granted in Section 16 shall be subject to the Encumbrances.
- (b) Subject to Section 17.2, Project Co shall perform all obligations of Contracting Authority under all Encumbrances for or on behalf of Contracting Authority, other than:
 - (i) obligations which Project Co is not legally capable of performing for or on behalf of Contracting Authority; and
 - (ii) obligations which the applicable counterparty to such Encumbrance formally relieves or waives Project Co from performing, with the consent of Contracting Authority, in its sole discretion (and if such relief or waiver is not consented to by Contracting Authority, and subject to Section 17.1(b)(i), Project Co shall perform such obligations in accordance with this Section 17).
- (c) Project Co, whether before, during or after the completion of the Works, shall not in any manner breach the Encumbrances.

17.2 No Encumbrances

- (a) Project Co shall not create, incur, permit or suffer to exist any Encumbrance to be created, filed, issued or registered upon or against the Lands or any part of them or any interest therein (i) due to an act or omission of Project Co or any Project Co Party, or (ii) arising in relation to the Works.

- (b) Project Co does not have title to the Lands or any interest therein, and no act or omission by Project Co or any Project Co Party shall give rise to a right for any person to obtain title to or any interest in the Lands or any part thereof, except:
- (i) as may be expressly agreed to in writing by Contracting Authority or the applicable third party owner of the Lands;
 - (ii) as may be expressly permitted by the terms of this Project Agreement; or
 - (iii) as may be permitted under Applicable Law, but without limiting Project Co's obligations under Sections 17.2(c)(i) and 17.3(a).
- (c) In the event that the Lands or any part thereof or any interest therein becomes subject to any Encumbrance following Financial Close,
- (i) due to an act or omission of Project Co or any Project Co Party (which has not been consented to in writing by Contracting Authority), or arising in relation to the Works, Project Co shall immediately take all steps necessary to terminate, remove, vacate or discharge such Encumbrance. If such Encumbrance is not terminated, removed, vacated or discharged within 10 Business Days after Project Co becoming aware of the creation, filing, issuance or registration of such Encumbrance, then, without prejudice to any other rights or remedies it may have, Contracting Authority may take whatever steps it deems necessary and appropriate, in its sole discretion, to terminate, remove, vacate or discharge the Encumbrance, including payment of any amount owing or claimed thereunder, and seek immediate recovery from Project Co of the amount of any such payment and any associated costs, including legal costs (on a full indemnity basis), all of which shall be payable on demand, and Project Co hereby appoints Contracting Authority as Project Co's attorney to execute any removal, vacating, termination or discharge of an Encumbrance referred to in this Section 17.2(c)(i) which appointment is coupled with an interest and shall be irrevocable for the Project Term and thereafter so long as any of Project Co's obligations under this Section 17.2(c)(i) are outstanding;
 - (ii) due to an act or omission of Project Co or any Project Co Party (which has been consented to in writing by Contracting Authority), or arising in relation to the Works, Project Co shall perform all obligations under such Encumbrance in accordance with Sections 17.1 and 17.3 (as is applicable) and at its sole cost and expense; or
 - (iii) which is not due to an act or omission of Project Co or any Project Co Party, or which has not arisen in relation to the Works, prior to performing obligations under any such Encumbrance, Project Co shall promptly notify Contracting Authority of any such Encumbrance and Contracting Authority may elect, in its sole discretion, to:
 - (A) have such Encumbrance be removed, vacated or discharged;
 - (B) perform the required obligations thereunder; or
 - (C) instruct Project Co to perform the required obligations thereunder.
- (d) For the purposes of this Section 17, if,

- (i) an encumbrance otherwise identified in Sections (b) (viii), (ix) or (x) of Schedule 16 – Encumbrances has not been complied with (excluding non-compliance by Project Co) and such non-compliance materially interferes with the use of the Lands for the purposes of the Works; or
- (ii) an encumbrance otherwise identified in Sections (b) (vii), (viii), (ix) or (x) of Schedule 16 – Encumbrances was not disclosed to Project Co and was not ascertainable through commercially standard off-title searches, and such encumbrance materially interferes with the use of the Lands for the purposes of the Works,

Contracting Authority shall be entitled to the same election as set out in Section 17.2(c)(iii), subject to Section 17.2(e). Project Co shall promptly notify Contracting Authority of any such encumbrance upon Project Co becoming aware of such encumbrance.

- (e) If Project Co is instructed to perform obligations under an Encumbrance pursuant to Section 17.2(c)(iii) or Section 17.2(d), which performance imposes costs or delays in the performance of Works, such performance shall, subject to and in accordance with Section 32, be treated as a Delay Event and, subject to and in accordance with Section 33, be treated as a Compensation Event.

17.3 Construction Act (Ontario)

- (a) The Parties acknowledge that Section 17.2 shall apply to claims for liens made against the Lands pursuant to the Construction Act and shall also apply to claims made against Contracting Authority or the holdback under the Construction Act as though such a claim were an Encumbrance against the Lands as referred to therein.
- (b) Project Co shall withhold from each Subcontractor the holdbacks required under the Construction Act and shall deal with such holdbacks in accordance with the Construction Act.
- (c) Project Co acknowledges that, notwithstanding that the same may be permitted under the Construction Act, there will be no early release of any amount of the Legislative Holdback which the Contracting Authority is required to retain under the Construction Act prior to the Legislative Holdback Payment Date, and that the same will be paid solely in accordance with Section 4.5.
- (d) Project Co shall, as a condition of final payment under any Subcontract for which lien rights or rights in respect of the holdback may be claimed under the Construction Act, require that a certificate of completion under section 33(1) of the Construction Act for such Subcontract be issued and the relevant Subcontractor provide statutory declarations or other assurances confirming that all those engaged by the Subcontractor have been paid in accordance with Applicable Law.
- (e) Project Co shall promptly provide Contracting Authority with a copy of any materials which are provided to the Lenders to evidence compliance with the Construction Act.
- (f) Upon request by Contracting Authority, Project Co shall perform and deliver to Contracting Authority a sub-search of title on the Lands or any part thereof. Contracting Authority shall pay the reasonable costs of any such search except (i) a search that reveals Encumbrances that are not permitted by this Project Agreement, (ii) a search requested based on a reasonable suspicion that

an Encumbrance that is not permitted by this Project Agreement has been registered on title to the Lands, and (iii) a search requested for the purpose of confirming that an Encumbrance that is not permitted by this Project Agreement has been discharged from title to the Lands.

- (g) Project Co shall cause a Payment Certifier to be appointed under the Design and Construction Contract and shall cause such Payment Certifier to certify the substantial performance of the Design and Construction Contract in accordance with the Construction Act.

18. SITE CONDITION

18.1 Acceptance of Site Condition

- (a) Subject to Sections 7.4, 18.1(b), 18.2, 18.3 and 18.4, Project Co acknowledges and agrees that it has inspected or investigated the Lands, the Existing Infrastructure (including the surroundings thereof) and the Site Conditions in accordance with Good Industry Practice taking into account all matters relating to the Lands (including the buildings, structures and works, on, over and under the Lands existing on the date hereof and the Background Information), the Existing Infrastructure and the Site Conditions prior to executing this Project Agreement and agrees to accept the Lands, the Existing Infrastructure and the Site Conditions on an “as is, where is” basis. Without limiting the generality of the foregoing, but subject to Sections 7.4, 18.1(b), 18.2, 18.3 and 18.4, Project Co shall not be entitled to make any claim of any nature whatsoever against Contracting Authority or any Province Person on any grounds relating to the Lands, the Existing Infrastructure or the Site Conditions, including the fact that incorrect or insufficient information on any matter relating to the Lands, the Existing Infrastructure or the Site Conditions was given to it by any person, whether or not Contracting Authority or a Province Person.
- (b) Section 18.1(a) is not intended to prohibit Project Co from relying upon information that has been provided by a person who has given Project Co an express written entitlement to rely on that information, provided however, subject to Sections 7.4, 18.2, 18.3 and 18.4, Project Co shall not be entitled to make any claim of any nature whatsoever against Contracting Authority or any Province Person on any grounds relating to the information provided by that person. For clarity, subject to Sections 7.4, 18.2, 18.3 and 18.4, Project Co’s legal recourse shall be against the person who provided the express written entitlement to rely on the information and not Contracting Authority or any Province Person.
- (c) Subject to Sections 7.4, 18.1(b), 18.2, 18.3 and 18.4, Project Co acknowledges and agrees that it has and shall be deemed to have:
 - (i) performed all necessary due diligence and investigations or inspections on the Lands, and examined the Lands and their surroundings and any existing works on, over or under the Lands in accordance with Good Industry Practice, taking into account all matters relating to the Lands, including any Existing Infrastructure, and any other buildings, structures and works, on, over and under the Lands existing on the date hereof;
 - (ii) performed all necessary due diligence and investigation or inspection on the Existing Infrastructure and satisfied itself prior to executing this Project Agreement as to the structural, environmental and general condition of such Existing Infrastructure;

- (iii) in accordance with Good Industry Practice, taking into account all matters relating to the Lands, including any Existing Infrastructure, and any other buildings, structures and works, on, over and under the Lands existing on the date hereof, satisfied itself as to the nature of the Site Conditions, the ground and the subsoil, the level and quantity of groundwater, the form and nature of the Lands, the loadbearing and other relevant properties of the Lands, the risk of injury or damage to property affecting the Lands, the nature of the materials (whether natural or otherwise) to be excavated and the nature of the design, work and materials necessary for the execution and delivery of the Works;
 - (iv) satisfied itself as to the presence of any Contamination on, in or under the Lands, or migrating to or from the Lands in accordance with Good Industry Practice, taking into account all matters relating to the Lands, including any Existing Infrastructure, and any other buildings, structures and works, on, over and under the Lands existing on the date hereof;
 - (v) satisfied itself as to the adequacy of the Lands, rights of access to, from and through the Lands and any accommodation it may require for the purposes of fulfilling its obligations under this Project Agreement;
 - (vi) satisfied itself as to the possibility of interference by persons of any description whatsoever with access to or use of, or rights in respect of, the Lands; and
 - (vii) satisfied itself as to the precautions, times and methods of working necessary to prevent any nuisance or interference, whether public or private, being caused to any third parties.
- (d) Project Co further acknowledges and agrees that, other than as referred to or contained in this Project Agreement, no representations or warranties have been made, nor documentation delivered to Project Co or any Project Co Party, which would indicate that Project Co would be unable to perform the Works in a lawful manner.

18.2 Contamination

- (a) Contracting Authority shall be responsible for Contamination on, in or under, or migrating to or from, the Lands, except for any such Contamination that,
 - (i) was within the actual knowledge of Project Co or a Project Co Party as of Commercial Close;
 - (ii) was described in, or was properly inferable, readily apparent or readily discoverable from, the Environmental Reports, the Geotechnical Reports or the Hazardous Materials Survey Reports;
 - (iii) subject to Section 18.2(c), could have been properly inferable, readily apparent or readily discoverable on the basis of investigations, inspections or other due diligence in accordance with Good Industry Practice, including as referred to in Section 18.1, where:
 - (A) physical access to any Lands was provided to Project Co or any Project Co Party by Contracting Authority prior to the RFP Submission Deadline; or

- (B) any Lands were publicly accessible by Project Co or any Project Co Party prior to the RFP Submission Deadline;

notwithstanding whether Project Co or any Project Co Party accessed such Lands and taking into account all matters relating to such Lands, including any Existing Infrastructure, and any other buildings, structures and works, on, over and under such Lands existing on the date hereof, but excluding any invasive testing, sampling or similar subsurface investigations which would otherwise be required by this Section 18.2(a)(iii);

- (iv) Project Co is obliged to remediate pursuant to the provisions of the Output Specifications;
- (v) is Minor System User Contamination; or
- (vi) is caused by Project Co or any Project Co Party.

For clarity, Project Co shall be responsible, at its sole cost and expense, for the Contamination set out in Sections 18.2(a)(i) to 18.2(a)(vi).

- (b) For the purposes of Section 18.2(a)(i) “actual knowledge” shall mean knowledge that is actually held by the person who was identified as the project manager (or analogous position) for the Project in Project Co’s proposal in response to the Request for Proposals.

- (c) For the purposes of Section 18.2(a)(iii):

- (i) Project Co acknowledges and agrees that,

- (A) contaminants listed in Table 3 of the MOECC Site Condition Standards, made pursuant to O. Reg. 153/04, as amended from time to time, in concentrations that are in excess of the Industrial/Commercial/Community Property Use standard for medium and fine textured soils; and

- (B) debris, ballast, aggregates and other non-soil materials,

may be present on, in or under, the Rail Corridor (including soil or groundwater that is on, in or under the Rail Corridor) and which may include contaminants set out in Section 18.2(c)(i)(A) that are migrating to, or are migrating from, the Rail Corridor (collectively, the “**Inferred Rail Corridor Contamination**”), and the Inferred Rail Corridor Contamination shall be deemed to be “properly inferable” by Project Co for the purpose of Section 18.2(a)(iii).

- (ii) If Project Co encounters soils that are on, in or under or that are migrating to or that are migrating from the Rail Corridor, and that contain,

- (A) “hazardous waste” as defined in Section 1 – Definitions of Ontario Regulation 347 – General – Waste Management, as amended from time to time (“**Hazardous Waste Soils**”); or

- (B) PCBs at a concentration of more than forty five parts per million by weight (45 microgram per gram, as reported by a Canadian Association for Laboratory

Accreditation Inc. certified analytical laboratory by analytical method EPA 8082a) (“**PCB Soils**”),

then the following shall apply:

- (C) Project Co shall be responsible for the characterization of the Hazardous Waste Soils or PCB Soils that require disposal off of the Lands or re-use to the satisfaction of the receiver or disposal site;
 - (D) Project Co shall, subject to and in accordance with Schedule 22 – Variation Procedure, be entitled to a Variation for any increase in cost between the disposal of soils described in Section 18.2(c)(i)(A) and the disposal of Hazardous Waste Soils or PCB Soils, provided that such disposal of Hazardous Waste Soils or PCB Soils is not otherwise required of Project Co under the Project Agreement, and not otherwise Project Co’s responsibility pursuant to Section 18.2(a)(i), Section 18.2(a)(ii), Section 18.2(a)(iv), Section 18.2(a)(v) or Section 18.2(a)(vi); and
 - (E) Project Co shall not be entitled to a Delay Event or a Compensation Event with respect to the discovery, characterization, re-use or disposal of any Hazardous Waste Soils or PCB Soils.
- (iii) If the MOECC directs Project Co, through an order issued pursuant to the *Environmental Protection Act* (Ontario), to dispose of soils that are on, in or under or that are migrating to or that are migrating from the Rail Corridor in a location that is not on the Lands, then the following shall apply:
- (A) Project Co shall be responsible for the characterization of the soils that require disposal off of the Lands or re-use to the satisfaction of the receiver or disposal site;
 - (B) Project Co shall, subject to and in accordance with Schedule 22 – Variation Procedure, be entitled to a Variation for the increase in cost between leaving the soils in situ and disposing of the soils in a location that is not on the Lands, provided that Project Co is not otherwise required to dispose of the soils under the Project Agreement, and provided that such disposal is not otherwise Project Co’s responsibility pursuant to Section 18.2(a)(i), Section 18.2(a)(ii), Section 18.2(a)(iv), Section 18.2(a)(v), or Section 18.2(a)(vi); and
 - (C) Project Co shall not be entitled to a Delay Event or a Compensation Event with respect to the discovery, characterization, re-use or disposal of the soils.
- (iv) If Project Co encounters groundwater during its performance of dewatering activities that is on, in or under, that is migrating to or that is migrating from, the Rail Corridor, and that does not meet the municipal bylaw requirements for disposal in a municipal sanitary sewer, then the following shall apply:

- (A) Project Co shall be responsible for the characterization of the groundwater that is derived from dewatering activities and that requires disposal in a location that is not a municipal sanitary sewer to the satisfaction of the receiver or disposal site;
 - (B) Project Co shall, subject to and in accordance with Schedule 22 – Variation Procedure, be entitled to a Variation for the lesser of,
 - (I) any increase in cost between the disposal of groundwater in a municipal sanitary sewer and the treatment of the groundwater to a condition that meets the municipal bylaw requirements for disposal in a municipal sanitary sewer, provided that such treatment of groundwater is not otherwise Project Co’s responsibility pursuant to Section 18.2(a)(i), Section 18.2(a)(ii), Section 18.2(a)(iv), Section 18.2(a)(v) or Section 18.2(a)(vi); and
 - (II) any increase in cost between the disposal of groundwater in a municipal sanitary sewer and the disposal of groundwater in a liquid waste handling facility operating under a MOECC environmental compliance approval, provided that such disposal of groundwater in a liquid waste handling facility is not otherwise Project Co’s responsibility pursuant to Section 18.2(a)(i), Section 18.2(a)(ii), Section 18.2(a)(iv), Section 18.2(a)(v) or Section 18.2(a)(vi); and
 - (C) Project Co shall not be entitled to a Delay Event or a Compensation Event with respect to the discovery, treatment, characterization, or disposal of any groundwater.
- (d) For clarity,
- (i) unless Project Co is otherwise responsible for Contamination in the Rail Corridor pursuant to Section 18.2(a)(i), Section 18.2(a)(ii), Section 18.2(a)(iv), Section 18.2(a)(v) or Section 18.2(a)(vi), Project Co’s only obligation pursuant to Section 18.2(c) with respect to Inferred Rail Corridor Contamination that is migrating from the Rail Corridor to a point outside of the Rail Corridor is to ensure that such Inferred Rail Corridor Contamination is dealt with in accordance with the Applicable Law, including any Applicable Law requirements to stop migration of the Inferred Rail Corridor Contamination to beyond the geographical boundaries of the Rail Corridor; and
 - (ii) Section 18.2(c) is not intended to change, or impact in any way, Project Co’s responsibility for Contamination outside of the boundaries of the Rail Corridor. Project Co’s obligations with respect to Contamination outside the Rail Corridor are governed by Sections 18.2(a), 18.2(b), 18.2(e), 18.2(f), 18.2(g), 18.2(h) and 18.2(i). For clarity, Sections 18.2(a)(i), 18.2(a)(ii), 18.2(a)(iv), 18.2(a)(v) and 18.2(a)(vi), 18.2(b), 18.2(e), 18.2(f), 18.2(g), 18.2(h) and 18.2(i) also apply to the Rail Corridor.
- (e) Upon the discovery of any Contamination for which Contracting Authority is responsible pursuant to Section 18.2(a), Project Co shall immediately inform the Contracting Authority Representative, and shall comply, and ensure that all Project Co Parties comply, with all Applicable Law and

Schedule 17 – Environmental Obligations in respect thereof at Contracting Authority’s cost, subject to and in accordance with Section 18.2(h).

- (f) Except to the extent required to prevent or mitigate an Emergency or to comply with Applicable Law, Project Co shall not undertake any significant work pursuant to Section 18.2(e) in respect of Contamination for which Contracting Authority is responsible pursuant to Section 18.2(a) until the Contracting Authority Representative has been given a reasonable opportunity to review the nature and extent of the Contamination and has instructed Project Co to proceed with such work.
- (g) In the event that Contracting Authority wishes Project Co to perform actions in respect of any Contamination which are in addition to any required pursuant to Section 18.2(e), then Contracting Authority shall issue an instruction to Project Co specifying what action Contracting Authority requires Project Co to take and Project Co shall promptly and diligently comply with all such instructions at Contracting Authority’s cost, subject to and in accordance with Section 18.2(h).
- (h) If Sections 18.2(e) and 18.2(g) require Project Co to perform any alteration, addition, Demolition, extension or variation in the Works as a result of Contamination for which Contracting Authority is responsible pursuant to Section 18.2(a) or as a result of any instructions given by Contracting Authority pursuant to Section 18.2(g) and which would not otherwise be required under this Project Agreement, then any such alteration, addition, Demolition, extension or variation in the Works shall, subject to and in accordance with Section 32, be treated as a Delay Event and, subject to and in accordance with Section 33, be treated as a Compensation Event.
- (i) In the event that Contracting Authority and Project Co do not agree as to the nature or extent of the Contamination or of the actions to be performed by Project Co pursuant to Section 18.2(e), such disagreement shall be referred for determination to an independent and suitably qualified and experienced person, acceptable to Project Co and Contracting Authority, each acting reasonably (and the costs and expenses of retaining such person shall be borne by the unsuccessful Party). Such person’s decision shall be final and binding on the Parties only in respect of the nature or extent of the Contamination and any action to be performed by Project Co pursuant to Section 18.2(e), except to the extent that either Party alleges that such decision would result in non-compliance with Applicable Law or this Project Agreement, in which event either Party may refer the disagreement for resolution in accordance with Schedule 27 – Dispute Resolution Procedure.

18.3 Items of Geological, Historical or Archaeological Interest or Value

- (a) As between the Parties, all fossils, artifacts and other objects having artistic, historic, archaeological or monetary value, including human remains and burial sites, which may be found on or at the Lands are or shall be the sole and absolute property of Contracting Authority or the owner of the relevant property, as applicable.
- (b) Contracting Authority shall be responsible for items referred to in Section 18.3(a) except for any such items that were described in, or were properly inferable, readily apparent or readily discoverable from any Archaeological Reports or any Cultural Heritage Reports.
- (c) Upon the discovery of any item referred to in Section 18.3(a), Project Co shall:
 - (i) immediately inform the Contracting Authority Representative of such discovery; and

- (ii) take all steps not to disturb the item and, if necessary, cease any Works in so far as performing such Works would endanger the item or prevent or impede its excavation, take all necessary steps to preserve and ensure the preservation of the item in the same position and condition in which it was found, and comply, and ensure that all Project Co Parties comply, with Applicable Law and all requirements of Governmental Authorities with respect to such discovery, including the *Funeral, Burial and Cremations Services Act, 2002* (Ontario) and the *Standards & Guidelines for Conservation of Provincial Heritage Properties issued under the Ontario Heritage Act* (Ontario):
 - (A) subject to and in accordance with Section 18.3(e), at Contracting Authority's cost, in respect of any such discovery for which Contracting Authority is responsible pursuant to Section 18.3(b); and
 - (B) at its own cost in respect of any such discovery for which it is responsible pursuant to Section 18.3(b).

Without limiting the foregoing or Project Co's obligations under Schedule 17 – Environmental Obligations, Project Co shall also perform all Works in a manner that ensures that Contracting Authority and the Works are in compliance with the Metrolinx Interim Heritage Management Protocol (2013).

- (d) In the event that Contracting Authority wishes Project Co to perform actions in respect of any discovery of any item referred to in Section 18.3(a) which are in addition to any required pursuant to Section 18.3(c), then Contracting Authority shall issue an instruction to Project Co specifying what action Contracting Authority requires Project Co to take and Project Co shall promptly and diligently comply with all such instructions at Contracting Authority's cost subject to and in accordance with Section 18.3(e).
- (e) If Section 18.3(c) or Section 18.3(d) require Project Co to perform any alteration, addition, Demolition, extension or variation in the Works, or to suspend or delay performance of the Works, as a result of any such discovery for which Contracting Authority is responsible pursuant to Section 18.3(b) or as a result of any instructions given by Contracting Authority pursuant to Section 18.3(d) and which would not otherwise be required under this Project Agreement, then any such alteration, addition, Demolition, extension or variation in the Works, or suspension or delay in the performance of the Works shall, subject to and in accordance with Section 32, be treated as a Delay Event and, subject to and in accordance with Section 33, be treated as a Compensation Event (but in the case of Section 18.3(c) only to the extent it directly results in the interruption of the Works during a continuous period of 14 days or more with respect to each such discovery).
- (f) In the event that Contracting Authority and Project Co do not agree as to the nature or extent of the actions required to be performed by Project Co pursuant to Section 18.3(c)(ii), such disagreement shall be referred for determination to an independent and suitably qualified and experienced person, acceptable to Project Co and Contracting Authority, each acting reasonably (and the costs and expenses of retaining such person shall be borne by the unsuccessful Party). Such person's decision shall be final and binding on the Parties except to the extent that either Party alleges that such decision would result in non-compliance with Applicable Law or this Project Agreement, in which event either Party may refer the disagreement for resolution in accordance with Schedule 27 – Dispute Resolution Procedure.

18.4 Unknown Utility Infrastructure

- (a) Project Co shall be responsible for all Utility Infrastructure on the Lands pursuant to Schedule 15 – Output Specifications, except for any Utility Infrastructure that is located on, in or under the Municipal Road Allowance, or Utility Infrastructure that is located on, in or under the Rail Corridor that,
- (i) was not within the actual knowledge of Project Co or a Project Co Party, as of Commercial Close; and
 - (ii) subject to Section 18.4(d), was not referenced or described in, or was not properly inferable, readily apparent or readily discoverable, from the Background Information,
- the (“**Unknown Utility Infrastructure**”).
- (b) For the purposes of Section 18.4(a)(i), “actual knowledge” shall mean knowledge that is actually held by the person who was identified as the project manager (or analogous position) for the Project in Project Co’s proposal in response to the Request for Proposals.
- (c) If Utility Infrastructure on the Site that is not the responsibility of Project Co pursuant to Section 18.4(a) delays Project Co’s performance of the Works then any such delay in the Works or additional costs in respect of the Works shall, subject to and in accordance with Section 32 be treated as a Delay Event and, subject to and in accordance with Section 33, be treated as a Compensation Event.
- (d) In respect of Utility Infrastructure that is located on, in or under the Rail Grade Separation Lands, Project Co shall not be eligible for the Delay Event or Compensation Event set out in this Section 18.4 in respect of any Utility Infrastructure that is outside of the study area limits represented by the Subsurface Utility Engineering (SUE) Reports.

18.5 Species-at-Risk

- (a) Contracting Authority shall be responsible for any Species-at-Risk which may be found on, in or at the Lands, except that Project Co shall be responsible for any Species-at-Risk which may be found on, in or under the Lands:
- (i) the occurrence of which, in the location in which it is found, was described in the Environmental Assessments; or
 - (ii) the occurrence of which is directly or indirectly caused by a failure by Project Co to comply with, or a breach or default by Project Co of, any of the provisions of this Project Agreement. For greater certainty, Project Co shall be responsible for new populations of Species-at-Risk in locations at the Lands where as a result of a failure by Project Co to comply with, or a breach or default of Project Co of, any of the provisions in this Project Agreement, conditions are created that are deemed suitable habitat for Species-at-Risk in accordance with Applicable Law.
- (b) In respect of Species-at-Risk for which Project Co is responsible pursuant to Section 18.5(a), Project Co shall, at its own cost, comply, and ensure compliance by all Project Co Parties, with

all Applicable Law and the provisions of Schedule 15 – Output Specifications and Schedule 17 – Environmental Obligations. Upon the discovery of any Species-at-Risk for which Contracting Authority is responsible pursuant to Section 18.5(a), Project Co shall:

- (i) immediately inform the Contracting Authority Representative of such discovery; and
 - (ii) comply, and ensure compliance by all Project Co Parties, with all Applicable Law and the provisions of Schedule 15 – Output Specifications and Schedule 17 – Environmental Obligations in respect thereof, including taking all necessary steps to preserve the respective habitat and relocate the Species-at-Risk at Contracting Authority’s cost pursuant to Section 18.5(d).
- (c) In the event that Contracting Authority wishes Project Co to perform actions which are in addition to any required pursuant to Section 18.5(b), then Contracting Authority shall issue an instruction to Project Co specifying what action Contracting Authority requires Project Co to take and Project Co shall promptly and diligently comply with all such instructions at Contracting Authority’s cost pursuant to Section 18.5(d).
- (d) If Section 18.5(b) or Section 18.5(c) require Project Co to perform any alteration, addition, demolition, extension or variation as a result of the discovery of any Species-at-Risk for which Contracting Authority is responsible pursuant to Section 18.5(a) or as a result of any instructions given by Contracting Authority pursuant to Section 18.5(c) and which would not otherwise be required under this Project Agreement, then any such alteration, addition, demolition, extension or variation:
- (i) prior to Substantial Completion shall, subject to and in accordance with Section 32, be treated as a Delay Event and, subject to and in accordance with Section 33, be treated as a Compensation Event; and
 - (ii) following Substantial Completion shall, subject to and in accordance with Schedule 22 – Variation Procedure, result in a Variation.

19. GOVERNMENTAL AND THIRD PARTY FINANCIAL OBLIGATIONS

19.1 Governmental, Railway and Utility Company Fees

- (a) Project Co shall be responsible for,
- (i) all Financial Obligations under or in respect of all Project Co Permits, Licences, Approvals and Agreements, including,
 - (A) any engineering, administration and inspection fees required in respect of works or services to be performed;
 - (B) any security deposits required under any Project Co Permits, Licences, Approvals and Agreements; and
 - (C) any other amounts payable under any Project Co Permits, Licences, Approvals and Agreements; and

- (ii) all Financial Obligations in respect of Contracting Authority Permits, Licences, Approvals and Agreements that are set out as being Project Co's responsibility in Schedule 15 – Output Specifications, Schedule 17 – Environmental Obligations or Appendix A to Schedule 1 – Permits, Licences, Approvals and Agreements, including any engineering, administration and inspection fees required in respect of works or services to be performed.
- (b) For clarity, and notwithstanding Section 19.1(a), Project Co shall not be responsible for payment of any development charges relating to the Works, the New Metrolinx Infrastructure, the New Third Party Infrastructure or the Lands.
- (c) Subject to Section 19.1(a)(ii), Contracting Authority shall be responsible for all Financial Obligations under or in respect of all the Contracting Authority Permits, Licences, Approvals and Agreements including such Financial Obligations, as applicable in either case, to the Municipality, any Utility Company, any Railway Company, any Governmental Authority or any other third party in respect of the Works, including:
 - (i) any engineering administration and inspection fees required in respect of works or services required to be performed;
 - (ii) any security deposits required under any Contracting Authority Permits, Licences, Approvals and Agreements; and
 - (iii) any other amounts payable under any Contracting Authority Permits, Licences, Approvals and Agreements.
- (d) The Parties agree that any refund, partial rebate or credit granted by Contracting Authority, the Municipality, any applicable Utility Company, any applicable Railway Company, or any applicable Governmental Authority or any other third party relating to the Financial Obligations referred to in Sections 19.1(a), 19.1(b) and 19.1(c) shall be for the benefit of Contracting Authority to the extent such Financial Obligations were paid by Contracting Authority and shall be for the benefit of Project Co to the extent such Financial Obligations were paid by Project Co. Without limiting the generality of the foregoing, to the extent that Contracting Authority enter into any cost sharing or cost reduction arrangements with the Municipality, any Utility Company, any Railway Company, any Governmental Authority or any third party, Project Co acknowledges and agrees that Contracting Authority shall be the sole beneficiary of any such cost sharing or cost reduction arrangements and Project Co shall have no entitlement whatsoever to any benefit arising from any such cost sharing or cost reduction arrangements.

20. CONTRACTING AUTHORITY ACCESS AND MONITORING

20.1 Contracting Authority Access During the Works

- (a) Subject to Section 20.1(b) but without limiting any of Contracting Authority's rights in respect of the Lands, the New Metrolinx Infrastructure, the New Third Party Infrastructure or the right of any third party in relation to that third party's portion of the Lands or New Third Party Infrastructure, Project Co acknowledges and agrees that Project Co shall not restrict the access of Contracting Authority, the Province Persons, and the Government Entities and their respective representatives, to,

- (i) the Lands, the New Metrolinx Infrastructure, the New Third Party Infrastructure or any workshop where materials, Plant or equipment are being manufactured, prepared or stored at all reasonable times during normal working hours, including for the purposes of general inspection or audit, or of attending any test or study being carried out in respect of the Works, or to fulfill any statutory, public or other duties or functions; or
- (ii) the Lands, the New Metrolinx Infrastructure, or the New Third Party Infrastructure for the purpose of operating a live rail transit system.

For clarity, nothing in this Section 20.1 shall restrict or impede Contracting Authority's or any other third party owner's right to use and access the Existing Infrastructure or any part of the Lands not required at that time for Project Co's performance of the Works in accordance with the terms hereof.

- (b) In exercising their access rights under Section 20.1(a) in respect of the Metrolinx Lands, Contracting Authority shall, and shall cause the Province Persons, the Government Entities, and their respective representatives, to:
 - (i) provide reasonable prior Notice appropriate to the circumstances (other than for any offices or other facilities provided for the use of Contracting Authority, Province Persons and/or Government Entities);
 - (ii) comply with all relevant safety procedures and any reasonable directions with regard to site safety that may be issued by or on behalf of the Project Co Representative from time to time; and
 - (iii) if required by Project Co, be accompanied by a representative of Project Co or a Project Co Party.

20.2 Increased Monitoring

- (a) If, at any stage, Contracting Authority is of the opinion, acting reasonably, that there are defects in the Works or that Project Co has failed to comply, in any material respect, with the requirements of this Project Agreement, Contracting Authority may, without prejudice to any other right or remedy available to it, by Notice to Project Co, increase the level of monitoring of Project Co from that set out in this Project Agreement to such level as Contracting Authority considers reasonable taking into account the nature of the relevant defect or failure until such time as Project Co shall have demonstrated, to Contracting Authority's satisfaction, that it is capable of performing and will perform, in all material respects, its obligations related to the Works under this Project Agreement. Project Co will compensate Contracting Authority for any reasonable costs incurred as a result of such increased monitoring.

20.3 Right to Uncover

- (a) Project Co shall ensure that Contracting Authority is afforded advance Notice of, and that Contracting Authority is afforded a full opportunity to witness, all inspection and test activity in accordance with the Inspection and Test Plan. If Project Co does not provide such Notice and opportunity, Project Co shall at the request of Contracting Authority uncover any relevant part of the Works which have been covered up or otherwise put out of view or remove any relevant part

of the Works that have been proceeded with in order to permit Contracting Authority to witness the relevant inspection or test activity. Project Co shall bear all costs of any such uncovering or removal, regardless of whether or not any defect is discovered in the relevant Works.

- (b) Contracting Authority shall have the right, at any time prior to the Final Completion Date, to request Project Co to uncover or open up and inspect (or allow Contracting Authority to inspect) any part or parts of the Works, or to require testing of any part or parts of the Works, where Contracting Authority reasonably believes that such part or parts of the Works is or are defective or that Project Co has failed to comply with the requirements of this Project Agreement (including the Design Data) relevant to such part or parts of the Works, and Project Co shall comply with such request. When Contracting Authority makes such a request, Contracting Authority shall include reasonably detailed reasons with such request.
- (c) If an inspection shows that the relevant part or parts of the Works is or are defective or that Project Co has failed to comply with the requirements of this Project Agreement (including the Design Data) relevant to such part or parts of the Works, Project Co shall rectify all such defects and non-compliance diligently and at no cost to Contracting Authority and Project Co shall not be entitled to any additional compensation or extension of time in relation thereto.
- (d) If an inspection shows that the relevant part or parts of the Works is or are not defective and that Project Co has complied with the requirements of this Project Agreement (including the Design Data) relevant to such part or parts of the Works, the exercise by Contracting Authority of its rights pursuant to this Section 20.3 shall, subject to and in accordance with Section 32, be treated as a Delay Event and, subject to and in accordance with Section 33, be treated as a Compensation Event.

20.4 No Relief from Obligations

- (a) The Parties acknowledge that the exercise by Contracting Authority or the Contracting Authority Representative of the rights under this Section 20 shall in no way affect the obligations of Project Co under this Project Agreement except as set out in this Section 20.

20.5 Access by Others

- (a) Subject to Section 20.5(b) and subject to and in accordance with Section 11.12 (to the extent applicable), Project Co shall ensure that throughout the Project Term, without prejudice to any access rights of any such person as a member of the general public or pursuant to Applicable Law, that it does not restrict access to the Lands, New Metrolinx Infrastructure, Existing Infrastructure, or New Third Party Infrastructure for:
 - (i) the Independent Certifier to the extent required to perform its obligations pursuant to Schedule 6 – Independent Certifier Agreement;
 - (ii) inspectors and other persons authorized to act on behalf of Contracting Authority and owners of New Third Party Infrastructure and Existing Third Party Infrastructure, for inspection and/or acceptance purposes;
 - (iii) all Other Contractors, including the owners or operators of any Third Party Facilities and their agents at all reasonable times to exercise any right or power or perform any duty or

obligation under any Applicable Law or the Utility Agreements, Railway Orders or encroachment permits, provided that, wherever consistent with the requirements of Applicable Law and the requirements of this Project Agreement, Project Co may limit such access so as to not unnecessarily impede or restrict traffic flows, the operation of the Existing Infrastructure or any Works;

- (iv) all Governmental Authorities and Emergency Service Providers in order to carry out any work (including surveys and inspections) in accordance with or to exercise any right or power or perform any duty or obligation under any Applicable Law and provided that, whenever consistent with the applicable requirements of such Governmental Authority, Emergency Service Providers or Applicable Law and the requirements of this Project Agreement (as the case may be), Project Co may limit such access so as to not unnecessarily impede or restrict traffic flows, the operation of the Existing Infrastructure or any Works;
 - (v) any Province Persons, Other Contractors, owners or operators of Third Party Facilities, Governmental Authorities, Emergency Service Providers, Utility Companies, Railway Companies, the Municipality, and Municipal Transit Systems for the purposes of access to and from any other lands and/or facilities adjacent to or in proximity to the Lands, the New Metrolinx Infrastructure, the New Third Party Infrastructure and Existing Infrastructure owned or operated by such person or in which such person has any interest, provided that, whenever consistent with the requirements of Applicable Law and the requirements of this Project Agreement, Project Co may limit such access so as to not unnecessarily impede or restrict traffic flows, the operation of the Existing Infrastructure or any Works; and
 - (vi) any Province Person to undertake emergency training in relation to the New Metrolinx Infrastructure.
- (b) Subject to Section 20.5(c), Contracting Authority shall require persons accessing Site(s) on the Metrolinx Lands in accordance with access rights under Section 20.5(a) to:
- (i) provide reasonable prior Notice to Project Co appropriate to the circumstances;
 - (ii) comply with all relevant health and safety procedures and any reasonable directions with regard to health and safety that may be issued by or on behalf of the Project Co Representative from time to time; and
 - (iii) if reasonably required by Project Co, be accompanied by a representative of Project Co or a Project Co Party.
- (c) Section 20.5(b) shall not apply,
- (i) to Additional Contractors, who shall instead comply with any instructions or procedures made by Project Co pursuant to Section 11.12;
 - (ii) in the case of access rights described in Section 20.5(a) for the purpose of responding to an Emergency;

- (iii) for the purposes of responding to an emergency declared by Contracting Authority or by a Governmental Authority; and
- (iv) in circumstance where the requirements of Section 20.5(b) are inconsistent with the requirements of the applicable Governmental Authority or Emergency Service Provider.

20.6 Public Use

- (a) Project Co shall have no right to grant, to the general public, the right to use either the New Metrolinx Infrastructure or the New Third Party Infrastructure. It shall be the right of Contracting Authority to grant the right of use to the general public to the New Metrolinx Infrastructure. It shall be the right of the applicable third party owner of the New Third Party Infrastructure to grant the right of use to the general public to the New Third Party Infrastructure.
- (b) Except as otherwise expressly provided in this Project Agreement, Project Co shall not have any claim whatsoever against Contracting Authority, any Province Person, any Emergency Service Providers or any other Governmental Authority for, or in respect of any lane closure or diversion or any track closure or diversion, including any such closure or diversion as a result of the exercise of any other rights or powers or the discharge of any other duties or functions by any such authority, affecting all or any part of the Lands, the New Metrolinx Infrastructure or the New Third Party Infrastructure, at any time.

20.7 Executive Project Meetings

- (a) Subject to Sections 20.7(b) and 20.7(c), during the Project Term, Contracting Authority, may, in its sole discretion and from time to time, schedule and hold meetings with senior executives of Project Co and the Project Co Parties for such individuals to provide senior executives of Contracting Authority with an update on the progress of and issues with the Project (each is an “**Executive Project Meeting**”).
- (b) Until Substantial Completion, within 20 Business Days of Financial Close and at the beginning of each calendar year thereafter, Contracting Authority may, in its sole discretion, provide Notice to Project Co (i) confirming if Executive Project Meetings will be held during that calendar year, and, if any such meetings will be held during that calendar year, (ii) setting out if such meetings shall be scheduled monthly, quarterly or on a one-time basis.
- (c) The precise date, time and location of each Executive Project Meeting shall be scheduled by Contracting Authority, acting reasonably.
- (d) Contracting Authority shall have the right to request the attendance of specific employees, officers, directors and other representatives of Project Co or any Project Co Party at each Executive Project Meeting, and, if requested to attend such meeting, Project Co shall use reasonably commercial efforts to ensure all such individuals attend.
- (e) No later than 10 Business Days prior to the date of each Executive Project Meeting, Project Co shall prepare and submit to Contracting Authority a one page (11” x 17” sized) summary (the “**Executive Project Meeting Document**”), which shall include the following information and be current to such date:

- (i) the date of the Executive Project Meeting Document (in month and year format);
- (ii) Project information, including the name of the Project, the name of Project Co and the names of the Project Co Parties, including their respective representatives in attendance;
- (iii) a high-level Project schedule in respect of the Works, including Commercial Close, Financial Close, the design development phase, the construction phase, the testing and commissioning phases, the Scheduled Substantial Completion Date, the anticipated Substantial Completion Date if such date is different from the Scheduled Substantial Completion Date, the Scheduled Final Completion Date, and any other material high-level items on the critical path of, as applicable, the Interim Baseline Works Schedule or the Baseline Works Schedule;
- (iv) a brief description of the status of the design process to date, including the number of (A) Submittals submitted to Contracting Authority pursuant to Schedule 10 – Review Procedure; (B) Submittals for which the Contracting Authority Representative has assigned a comment of “NO COMMENT”, “MINOR NON-CONFORMANCE”, “MAJOR NON-CONFORMANCE” or “CRITICAL NON-CONFORMANCE” pursuant to Schedule 10 – Review Procedure; (C) Submittals under review by Contracting Authority pursuant to Schedule 10 – Review Procedure; and (D) Submittals scheduled to be submitted to Contracting Authority pursuant to Schedule 10 – Review Procedure within six months following the Executive Project Meeting;
- (v) a brief high-level description of the Construction Activities undertaken since the previous Executive Project Meeting, including three distinct progress photos;
- (vi) Earned Value Metrics (as defined in Schedule 12 – Works Schedule Requirements) progress per construction month;
- (vii) a brief description of the top five issues Project Co desires to bring to the attention of Contracting Authority;
- (viii) the number of total recordable injuries, lost time injuries, and non-lost time injuries per construction month;
- (ix) the number of Non-Conformance Reports issued since Financial Close for each construction month by type (i.e. Critical Non-Conformance, Major Non-Conformance, and Minor Non-Conformance);
- (x) the number of Project Co Permits, Licenses, Approvals and Agreements opened and closed with an emphasis on delayed applications; and
- (xi) any other information requested by Contracting Authority, acting reasonably.

21. SUSTAINABILITY AND ENVIRONMENTAL REQUIREMENTS

21.1 Sustainability Requirements

- (a) Project Co shall comply with all sustainability requirements set out in Schedule 15 – Output Specifications.

21.2 Environmental Requirements

- (a) Project Co and Contracting Authority shall comply with the provisions of Schedule 17 – Environmental Obligations.

22. INDEPENDENT CERTIFIER

22.1 Appointment

- (a) On or prior to Financial Close, the Parties shall appoint an independent and suitably qualified and experienced consultant to act as the Independent Certifier for the purposes of this Project Agreement and shall enter into an agreement with the Independent Certifier substantially in the form of Schedule 6 – Independent Certifier Agreement. If the Parties are unable to agree upon the Independent Certifier within such period of time, then the determination of the Independent Certifier shall be made in the same manner as the identification of a replacement Independent Certifier under Section 22.7(b).
- (b) Neither Party shall, without the prior written consent of the other Party, enter into any agreement with the Independent Certifier in connection with the Project other than the Independent Certifier Agreement, and Project Co shall ensure that no Project Co Party enters into any separate agreement with the Independent Certifier in connection with the Project.

22.2 Role of Independent Certifier

- (a) The general role, obligations and functions of the Independent Certifier are described in Schedule 6 – Independent Certifier Agreement.

22.3 Changes to Terms of Appointment

- (a) Neither Contracting Authority nor Project Co shall without the other's prior written approval:
 - (i) waive, settle, compromise or otherwise prejudice any rights or claims which the other may from time to time have against the Independent Certifier; or
 - (ii) vary the terms of the Independent Certifier Agreement or the services performed or to be performed by the Independent Certifier.
- (b) The Parties shall perform their respective obligations arising under or in connection with the Independent Certifier Agreement.

22.4 Right to Change Appointment

- (a) The Parties agree that the Independent Certifier shall not provide any services or reports or other information to Project Co, the Lenders, the Project Co Parties or any other person other than pursuant to the performance of the functions of the Independent Certifier under this Project Agreement unless agreed to in writing by the Parties. The Parties may agree to terminate the Independent Certifier Agreement upon 30 days' Notice to the Independent Certifier. If such Notice is given, then, pursuant to Section 22.7, a new Independent Certifier will be appointed. The Parties agree that, notwithstanding the 30 days' Notice of termination, the Independent Certifier shall continue on a day-to-day basis thereafter until a new Independent Certifier is appointed.

22.5 Cooperation

- (a) The Parties agree to cooperate with each other generally in relation to all matters within the scope of or in connection with the Independent Certifier Agreement. All instructions and representations issued or made by either of the Parties to the Independent Certifier shall be simultaneously copied to the other and the Parties shall be entitled to attend all inspections performed by or meetings involving the Independent Certifier.

22.6 Payment of Independent Certifier

- (a) Project Co and Contracting Authority shall share equally the responsibility for the payment of all fees and costs of the Independent Certifier.

22.7 Replacement

- (a) In the event of the Independent Certifier's engagement being terminated otherwise than for full performance, the Parties shall liaise and cooperate with each other in order to appoint a replacement consultant to act as the Independent Certifier as soon as reasonably practicable. The identity of any such replacement shall be as agreed by the Parties and the terms of his/her appointment shall, unless otherwise agreed by the Parties, be as set out in the Independent Certifier Agreement.
- (b) In the event the Parties fail to agree upon the identity of a replacement Independent Certifier within five Business Days after the termination of the original Independent Certifier's appointment, then a replacement Independent Certifier shall be chosen as follows:
- (i) each Party shall, within five Business Days thereafter, select three suitably qualified and experienced replacements that would be acceptable to that Party, and shall provide Notice thereof to the other Party, with a ranking of preference for replacements;
 - (ii) if the Parties have both selected a common replacement, then such common replacement shall be the Independent Certifier, and if there is more than one common replacement, then the common replacement with the highest overall ranking (calculated by adding together the ordinal rank assigned by the Parties) shall be selected, and in the event of a tie, the lowest-cost of such tied replacements shall be selected; and

- (iii) if the Parties have not selected a common replacement, then the determination of the new replacement may be referred for resolution in accordance with Schedule 27 – Dispute Resolution Procedure.

23. INTENTIONALLY DELETED

24. INTERIM COMPLETION COMMISSIONING AND COMPLETION

24.1 Interim Completion Commissioning Activities

- (a) Project Co shall perform all Interim Completion Project Co Commissioning, and shall facilitate the performance of all Interim Completion Contracting Authority Commissioning, pursuant to the Interim Completion Commissioning Program.

24.2 Interim Completion Commissioning Program

- (a) Project Co shall prepare a draft of the Interim Completion Commissioning Program in respect of the Interim Completion Project Co Commissioning and the Interim Completion Contracting Authority Commissioning and shall provide a copy thereof to the Independent Certifier, the Contracting Authority Commissioning Consultant and the Contracting Authority Representative not less than 180 days prior to the Scheduled Interim Completion Date.
- (b) The Interim Completion Commissioning Program shall, at a minimum:
 - (i) describe the requirements, and the timing and sequence of such requirements, necessary in order that the Interim Completion Project Co Commissioning shall be completed to achieve Interim Completion on or before the Scheduled Interim Completion Date;
 - (ii) describe the requirements, and the timing and sequence of such requirements, of the Interim Completion Contracting Authority Commissioning activities;
 - (iii) comply with all requirements of the Outline Commissioning Program and include all details, including for all appendices, required to be completed in the Outline Commissioning Program;
 - (iv) be consistent with the Outline Commissioning Program and impose no greater or more onerous obligations on Contracting Authority than those set out in the Outline Commissioning Program, unless otherwise agreed to by Contracting Authority;
 - (v) include the names of the individuals or companies proposed to perform all Interim Completion Project Co Commissioning;
 - (vi) include a schedule of each of the Interim Completion Project Co Commissioning Tests and the Interim Completion Contracting Authority Commissioning Tests proposed to be performed and the timeframe for completion, with start and end dates;
 - (vii) include a schedule of meetings to be held between the Parties to coordinate the performance of the Interim Completion Project Co Commissioning and the Interim Completion Contracting Authority Commissioning;

- (viii) provide for the re-verification of systems following the Interim Completion Contracting Authority Commissioning; and
 - (ix) list the approvals required from any Governmental Authority, manufacturer or other person that are necessary to meet the requirements of the Interim Completion Commissioning Program or Applicable Law.
- (c) Contracting Authority shall provide Project Co with comments on the draft Interim Completion Commissioning Program in accordance with the procedures contemplated by Section 4.1 of Schedule 10 – Review Procedure, and Project Co shall revise the draft Interim Completion Commissioning Program to the extent contemplated by Schedule 10 – Review Procedure within 30 days of receipt of any comments from Contracting Authority.
- (d) When agreed by the Parties, the Interim Completion Commissioning Program shall replace the Outline Commissioning Program with respect to Interim Completion.

24.3 Commencement of Interim Completion Project Co Commissioning

- (a) Project Co shall give 30 days’ written Notice to the Independent Certifier, the Contracting Authority Commissioning Consultant and the Contracting Authority Representative of the proposed commencement of the Interim Completion Project Co Commissioning.
- (b) Project Co shall give at least five Business Days’ Notice to, and shall invite, the Independent Certifier, the Contracting Authority Commissioning Consultant and the Contracting Authority Representative to witness, and to comment on, each aspect of the Interim Completion Project Co Commissioning. Project Co shall, together with such notice, provide all information that the Independent Certifier, the Contracting Authority Commissioning Consultant and the Contracting Authority Representative may reasonably require in relation thereto, including:
- (i) tests proposed;
 - (ii) test methodology; and
 - (iii) expected test results.

24.4 Interim Completion Certificate

- (a) Project Co shall give the Independent Certifier and the Contracting Authority Representative at least 10 Business Days’ Notice prior to the date upon which Project Co anticipates delivering the Interim Completion Notice (the “**Interim Completion 10-Day Notice**”).
- (b) Project Co shall deliver notice to the Independent Certifier and the Contracting Authority Representative upon the satisfaction of all of the requirements for Interim Completion under the Project Agreement (the “**Interim Completion Notice**”). The Interim Completion Notice shall (i) describe, in reasonable detail, the satisfaction of the requirements for Interim Completion, (ii) include as appendices all of the Interim Completion Deliverables described in the Interim Completion Deliverables List and (iii) include Project Co’s opinion that the conditions for issuance of the Interim Completion Certificate under the Project Agreement have been satisfied.

- (c) Within two Business Days of receiving the Interim Completion Notice from Project Co, the Independent Certifier shall review the Interim Completion Notice to determine whether or not the Interim Completion Notice includes all of the Interim Completion Deliverables described in the Interim Completion Deliverables List. For the purposes of this Section 24.4(c), if the Interim Completion Notice contains an Interim Completion Deliverable that, in the reasonable opinion of the Independent Certifier, is of such poor quality that it would impede, in a material way, the ability of Contracting Authority and the Independent Certifier to assess whether or not the requirements for Interim Completion under this Project Agreement have been satisfied, then such Interim Completion Deliverable shall be deemed to have not been included as part of the Interim Completion Notice. Following such review and determination by the Independent Certifier and before the expiry of such two Business Day period, the Independent Certifier shall either deliver notice to Project Co and Contracting Authority:
- (i) confirming that the Interim Completion Notice includes all of the Interim Completion Deliverables described in the Interim Completion Deliverables List (the “**IC Interim Completion Deliverables Confirmation**”); or
 - (ii) setting out a list of the Interim Completion Deliverables that were not included in the Interim Completion Notice (an “**IC Interim Completion Deliverables Deficiencies List**”).

If the Independent Certifier provides a notice to Project Co and Contracting Authority setting out an IC Interim Completion Deliverables Deficiencies List pursuant to this Section 24.4(c), then Project Co shall subsequently submit a new and replacement version of the Interim Completion Notice pursuant to Section 24.4(b), which, for greater certainty, includes all of the Interim Completion Deliverables, and the process described in this Section 24.4(c) shall be repeated until the IC Interim Completion Deliverables Confirmation is provided by the Independent Certifier to Project Co and Contracting Authority.

- (d) Contracting Authority shall, within five Business Days after receipt of the IC Interim Completion Deliverables Confirmation, provide the Independent Certifier and Project Co with Contracting Authority’s opinion as to whether the conditions for issuance of the Interim Completion Certificate have been satisfied or, if applicable, any reasons as to why Contracting Authority considers that the Interim Completion Certificate should not be issued.
- (e) Within five Business Days after Project Co’s receipt of Contracting Authority’s opinion pursuant to Section 24.4(d), the Parties shall cause the Independent Certifier to determine whether the conditions for issuance of the Interim Completion Certificate have been satisfied, having regard for the opinions of both Project Co and Contracting Authority, to determine whether any Interim Completion Minor Deficiencies exist, and to issue to Contracting Authority and to Project Co either:
- (i) the Interim Completion Certificate, confirming the date of issue as the Interim Completion Date and setting out the Interim Completion Minor Deficiencies List (if applicable) in accordance with Section 24.9; or
 - (ii) a report detailing the matters that the Independent Certifier considers are required to be performed by Project Co to satisfy the conditions for issuance of the Interim Completion

Certificate, including any items on the Interim Completion Minor Deficiencies List which remain outstanding

- (f) Where the Independent Certifier has issued a report in accordance with Section 24.4(e)(ii) and Project Co has not referred a Dispute in relation thereto for resolution in accordance with Schedule 27 – Dispute Resolution Procedure, Project Co shall, within 5 Business Days after receipt of such report, provide the Independent Certifier and the Contracting Authority Representative with:
- (i) a detailed list indicating the rectification actions proposed for all matters raised in such report;
 - (ii) the schedule for completion of all such rectification actions; and
 - (iii) any additional Interim Completion Project Co Commissioning that needs to be undertaken as a result of the rectification actions,

and Project Co shall perform all such additional rectification actions and Interim Completion Project Co Commissioning in a timely manner. Upon completion thereof, and for each new subsequent application for Interim Completion, Project Co shall submit a new Interim Completion 10-Day Notice and a new Interim Completion Notice and the process described in Sections 24.4(c) to (f), inclusive, shall be repeated until the Interim Completion Certificate has been issued.

- (g) In the event the Interim Completion Certificate has not been issued within 30 days after the delivery of an Interim Completion 10-Day Notice or the delivery of an Interim Completion Notice, such Interim Completion 10-Day Notice or Interim Completion Notice, as applicable, shall be deemed to have been rescinded by Project Co and Project Co shall be required to deliver a new Interim Completion 10-Day Notice in order to initiate a new application for Interim Completion.
- (h) For greater certainty, the Independent Certifier’s decision to issue the IC Interim Completion Deliverables Confirmation shall not limit or otherwise affect (i) any of Project Co’s obligations under this Project Agreement to satisfy the requirements of Interim Completion or (ii) the opinion of Contracting Authority or the determination of the Independent Certifier as to whether the conditions for issuance of the Interim Completion Certificate have been satisfied pursuant to Section 24.4(d) and Section 24.4(e) respectively.
- (i) Intentionally Deleted.
- (j) Project Co shall provide As Built Drawings, Record Drawings and specifications, Design Data, spare parts and Shop Drawings as soon as possible and in any event no later than 30 days after the Interim Completion Date.

24.5 Operation and Maintenance Manuals – Interim Completion Works

- (a) Project Co shall prepare and deliver to Contracting Authority draft copies of all necessary operation and maintenance manuals for the Interim Completion Works in the format set out in the Output Specifications no later than 30 days prior to the Interim Completion Date.

24.6 Intentionally Deleted

24.7 Interim Completion Contracting Authority Commissioning

- (a) The Parties acknowledge that the Interim Completion Contracting Authority Commissioning may be performed both before and after the Interim Completion Date. Prior to Interim Completion, Project Co shall give Contracting Authority full access to the Lands, the New Metrolinx Infrastructure and the New Third Party Infrastructure and all relevant parts thereof at such times as may be set out in the Interim Completion Commissioning Program to enable Contracting Authority to undertake the Interim Completion Contracting Authority Commissioning in accordance with the Interim Completion Commissioning Program. Contracting Authority shall comply, and shall ensure that all Contracting Authority Parties comply, with the directions, procedures and safety guidelines established by Project Co for the Lands and shall use commercially reasonable efforts to minimize disruption to the Works in performing the Interim Completion Contracting Authority Commissioning.
- (b) Contracting Authority acknowledges that, during the Interim Completion Contracting Authority Commissioning Period, Project Co and each Subcontractor will be active on the Lands, the New Metrolinx Infrastructure and the New Third Party Infrastructure, in both the completion and rectification of Interim Completion Minor Deficiencies and the completion of Interim Completion Project Co Commissioning, and Contracting Authority shall take commercially reasonable steps to allow such activities to proceed in accordance with the Interim Completion Commissioning Program.
- (c) Project Co acknowledges that, prior to and during the Interim Completion Contracting Authority Commissioning Period, Project Co and each Subcontractor shall cooperate with Contracting Authority and all Contracting Authority Parties and use commercially reasonable efforts to ensure that all requirements, and the timing and sequence of such requirements, of the Interim Completion Contracting Authority Commissioning activities are able to be completed in the timeframe for completion set out in the Interim Completion Commissioning Program.

24.8 Interim Completion Countdown Notice and Completion Deliverables

- (a) Project Co shall deliver a Notice (the “**Interim Completion Countdown Notice**”) to Contracting Authority and the Independent Certifier specifying the date on which Project Co anticipates that Interim Completion will be achieved (the “**Anticipated Interim Completion Date**”).
- (b) The Interim Completion Countdown Notice shall be delivered not less than 90 days prior to the Anticipated Interim Completion Date. If Project Co fails to deliver the Interim Completion Countdown Notice not less than 90 days prior to the Scheduled Interim Completion Date, the Anticipated Interim Completion Date shall be deemed to be the same date as the Scheduled Interim Completion Date.
- (c) Intentionally Deleted.
- (d) In accordance with Section 13.4(a), the Anticipated Interim Completion Date shall not be earlier than the Scheduled Interim Completion Date without the prior written consent of Contracting Authority, in its sole discretion.

- (e) Within 15 Business Days of the Independent Certifier's receipt of the Interim Completion Countdown Notice in accordance with Section 24.8(a), the Independent Certifier, in consultation with Project Co and Contracting Authority, shall prepare and deliver to Project Co and Contracting Authority a list of deliverables (the "**Interim Completion Deliverables List**") that (A) are to be appended to and form part of the Interim Completion Notice to be submitted by Project Co pursuant to Section 24.4(b), and (B) will constitute a minimum amount of evidence necessary for Project Co, in the Interim Completion Notice, to describe, in reasonable detail, the satisfaction of the requirements for Interim Completion and to support Project Co's opinion that the conditions for issuance of the Interim Completion Certificate have been satisfied (collectively, the "**Interim Completion Deliverables**").
- (f) From time to time until the date that is 60 days prior to the Anticipated Interim Completion Date, the Independent Certifier, in consultation with Project Co and Contracting Authority, may amend the Interim Completion Deliverables List, including to set out any additional Interim Completion Deliverables not identified in the Interim Completion Deliverables List pursuant to Section 24.8(e). Each amended Interim Completion Deliverables List shall, following its preparation, be deemed to be the Interim Completion Deliverables List for the purposes of this Project Agreement and be promptly delivered to Project Co and Contracting Authority.
- (g) For greater certainty, nothing in Section 24.8(e) or Section 24.8(f) limits or otherwise affects any of Project Co's obligations under this Project Agreement to satisfy the requirements of Interim Completion or to describe, in reasonable detail, the satisfaction of such requirements in the Interim Completion Notice pursuant to Section 24.8(b).

24.9 Interim Completion Minor Deficiencies

- (a) In the event that any Interim Completion Minor Deficiencies exist when Project Co gives the Interim Completion Notice, the Independent Certifier, in consultation with Project Co and Contracting Authority, shall prepare a list of all Interim Completion Minor Deficiencies (the "**Interim Completion Minor Deficiencies List**") identified at that time and an estimate of the cost and the time for rectifying such Interim Completion Minor Deficiencies.
- (b) The Interim Completion Minor Deficiencies List will contain the schedule for the completion and rectification of the Interim Completion Minor Deficiencies. The timeframe for the completion or rectification of each Interim Completion Minor Deficiency for Interim Completion shall be no later than six months following the Interim Completion Date. In determining the relevant time for rectifying Interim Completion Minor Deficiencies, Project Co shall schedule the completion and rectification of Interim Completion Minor Deficiencies so as to,
 - (i) comply with the Access Management Plan and all rules, requirements and restrictions relating to access, rail safety and operations and track protection, all as set out in Schedule 15 – Output Specifications and Schedule 34 – Rail Corridor Access and Flagging; and
 - (ii) minimize, to the greatest extent reasonably possible,
 - (A) any disruption of the Works or restrictions or other impairment of the public's use and enjoyment of the Interim Completion Works or any portion thereof; and

- (B) any disruption of the operations of Contracting Authority, any Province Person, any Governmental Authority or any Other Contractor, including the performance of the Governmental Activities and the Other Works.
- (c) The Independent Certifier must prepare the Interim Completion Minor Deficiencies List in relation to the Interim Completion Notice before the Interim Completion Certificate is issued, but shall not withhold the Interim Completion Certificate by reason solely that there are Interim Completion Minor Deficiencies.
- (d) Contracting Authority may, in its sole discretion, waive any requirement for Interim Completion, including with respect to equipment, and the failure to meet any such requirement shall constitute an Interim Completion Minor Deficiency.

24.10 Rectification of Interim Completion Minor Deficiencies

- (a) Project Co shall, in consultation with Contracting Authority Representative and so as to,
 - (i) comply with the Access Management Plan and all rules, requirements and restrictions relating to access, rail safety and operations and track protection, all as set out in Schedule 15 – Output Specifications and Schedule 34 – Rail Corridor Access and Flagging; and
 - (ii) minimize, to the greatest extent reasonably possible,
 - (A) any disruption of the Works or restrictions or other impairment of the public’s use and enjoyment of the Interim Completion Works or any portion thereof; and
 - (B) any disruption of the operations of Contracting Authority, any Province Person, any Governmental Authority or any Other Contractor, including the performance of the Governmental Activities and the Other Works,

complete and rectify all Interim Completion Minor Deficiencies within 45 days after the issuance of the Interim Completion Minor Deficiencies List or such other period as the Independent Certifier may specify in the Interim Completion Minor Deficiencies List, provided that Project Co shall complete and rectify all Interim Completion Minor Deficiencies for Interim Completion no later than six months following the Interim Completion Date.

- (b) Project Co acknowledges and agrees that the completion and rectification of Interim Completion Minor Deficiencies may require work outside of normal working hours in order to accommodate the efficient operation of the Interim Completion Works.

24.11 Failure to Rectify Interim Completion Minor Deficiencies

- (a) If Project Co has failed to complete and rectify any Interim Completion Minor Deficiency specified in the Interim Completion Minor Deficiencies List within:
 - (i) 30 days after the issuance of the Interim Completion Minor Deficiencies List; or

- (ii) such longer period as may be specified by the Independent Certifier in the Interim Completion Minor Deficiencies List, provided that in no event shall such period exceed six months following the Interim Completion Date,

Contracting Authority may engage others to perform the work necessary to complete and rectify any such Interim Completion Minor Deficiencies, at the risk and cost of Project Co.

- (b) Intentionally Deleted.

24.12 Effect of Certificate/Use

- (a) The issue of the Interim Completion Certificate and any taking over or use by Contracting Authority of any part of the Interim Completion Works under the terms of this Project Agreement, shall, in no way:
 - (i) limit the obligations of Project Co under this Project Agreement including in respect of any defects, deficiencies or items of outstanding work existing or discovered prior to or after the date of any of such certificates or the date of the Interim Completion Minor Deficiencies List; or
 - (ii) be construed as an approval by Contracting Authority of the Works or the way in which they have been carried out.

25. COMMISSIONING AND COMPLETION

25.1 Commissioning Activities

- (a) Project Co shall perform all Project Co Commissioning, and shall facilitate the performance of all Contracting Authority Commissioning, pursuant to the Final Commissioning Program.

25.2 Final Commissioning Program

- (a) Project Co shall prepare a draft of the Final Commissioning Program in respect of the Project Co Commissioning and the Contracting Authority Commissioning and shall provide a copy thereof to the Independent Certifier, the Contracting Authority Commissioning Consultant and the Contracting Authority Representative not less than 180 days prior to the Scheduled Substantial Completion Date.
- (b) The Final Commissioning Program shall, at a minimum:
 - (i) describe the requirements, and the timing and sequence of such requirements, necessary in order that the Project Co Commissioning shall be completed to achieve:
 - (A) Substantial Completion on or before the Scheduled Substantial Completion Date; and
 - (B) Final Completion on or before the Scheduled Final Completion Date;
 - (ii) describe the requirements, and the timing and sequence of such requirements, of the Contracting Authority Commissioning activities;

- (iii) comply with all requirements of the Outline Commissioning Program and include all details, including for all appendices, required to be completed in the Outline Commissioning Program;
 - (iv) be consistent with the Outline Commissioning Program and impose no greater or more onerous obligations on Contracting Authority than those set out in the Outline Commissioning Program, unless otherwise agreed to by Contracting Authority;
 - (v) include the names of the individuals or companies proposed to perform all Project Co Commissioning;
 - (vi) include a schedule of each of the Project Co Commissioning Tests and the Contracting Authority Commissioning Tests proposed to be performed and the timeframe for completion, with start and end dates;
 - (vii) include a schedule of meetings to be held between the Parties to coordinate the performance of the Project Co Commissioning and the Contracting Authority Commissioning;
 - (viii) provide for the re-verification of systems following the Contracting Authority Commissioning; and
 - (ix) list the approvals required from any Governmental Authority, manufacturer or other person that are necessary to meet the requirements of the Final Commissioning Program or Applicable Law.
- (c) Contracting Authority shall provide Project Co with comments on the draft Final Commissioning Program in accordance with the procedures contemplated by Schedule 10 – Review Procedure, and Project Co shall revise the draft Final Commissioning Program to the extent contemplated by Schedule 10 – Review Procedure within 30 days after receipt of any comments from Contracting Authority.
- (d) When agreed by the Parties, the Final Commissioning Program shall replace the Outline Commissioning Program with respect to Substantial Completion and Final Completion.

25.3 Commencement of Project Co Commissioning

- (a) Project Co shall give 30 days' written Notice to the Independent Certifier, the Contracting Authority Commissioning Consultant and the Contracting Authority Representative of the proposed commencement of the Project Co Commissioning.
- (b) Project Co shall give at least five Business Days' Notice to, and shall invite, the Independent Certifier, the Contracting Authority Commissioning Consultant and the Contracting Authority Representative to witness, and to comment on, each aspect of the Project Co Commissioning. Project Co shall, together with such Notice, provide all information that the Independent Certifier, the Contracting Authority Commissioning Consultant and the Contracting Authority Representative may reasonably require in relation thereto, including:
 - (i) tests proposed;

- (ii) test methodology; and
- (iii) expected test results.

25.4 Substantial Completion Certificate

- (a) Project Co shall give the Independent Certifier and the Contracting Authority Representative at least 10 Business Days' Notice prior to the date upon which Project Co anticipates delivering the Substantial Completion Notice (the "**Substantial Completion 10-Day Notice**").
- (b) Project Co shall deliver notice to the Independent Certifier and the Contracting Authority Representative upon the satisfaction of all of the requirements for Substantial Completion, under this Project Agreement (the "**Substantial Completion Notice**"). The Substantial Completion Notice shall (i) describe, in reasonable detail, the satisfaction of the requirements for Substantial Completion, (ii) include as appendices of the Substantial Completion Deliverables described in the Substantial Completion Deliverables List, and (iii) include Project Co's opinion that the conditions for issuance of the Substantial Completion Certificate under this Project Agreement have been satisfied.
- (c) Within two Business Days of receiving the Substantial Completion Notice from Project Co, the Independent Certifier shall review the Substantial Completion Notice to determine whether or not the Substantial Completion Notice includes all of the Substantial Completion Deliverables described in the Substantial Completion Deliverables List. For the purposes of this Section 25.4(c), if the Substantial Completion Notice contains a Substantial Completion Deliverable that, in the reasonable opinion of the Independent Certifier, is of such poor quality that it would impede, in a material way, the ability of Contracting Authority and the Independent Certifier to assess whether or not the requirements for Substantial Completion under this Project Agreement have been satisfied, then such Substantial Completion Deliverable shall be deemed to have not been included as part of the Substantial Completion Notice. Following such review and determination by the Independent Certifier and before the expiry of such two Business Day period, the Independent Certifier shall either deliver notice to Project Co and Contracting Authority:
 - (i) confirming that the Substantial Completion Notice includes all of the Substantial Completion Deliverables described in the Substantial Completion Deliverables List (the "**IC Substantial Completion Deliverables Confirmation**"); or
 - (ii) setting out a list of the Substantial Completion Deliverables that were not included in the Substantial Completion Notice (an "**IC Substantial Completion Deliverables Deficiencies List**").

If the Independent Certifier provides a notice to Project Co and Contracting Authority setting out an IC Substantial Completion Deliverables Deficiencies List pursuant to this Section 25.4(c), then Project Co shall subsequently submit a new and replacement version of the Substantial Completion Notice pursuant to Section 25.4(b), which, for greater certainty, includes all of the Substantial Completion Deliverables, and the process described in this Section 25.4(c) shall be repeated until the IC Substantial Completion Deliverables Confirmation is provided by the Independent Certifier to Project Co and Contracting Authority.

- (d) Contracting Authority shall, within five Business Days after receipt of the IC Substantial Completion Deliverables Confirmation, provide the Independent Certifier and Project Co with Contracting Authority's opinion as to whether the conditions for issuance of the Substantial Completion Certificate have been satisfied or, if applicable, any reasons as to why Contracting Authority considers that the Substantial Completion Certificate should not be issued.
- (e) Within five Business Days after Project Co's receipt of Contracting Authority's opinion pursuant to Section 25.4(d), the Parties shall cause the Independent Certifier to determine whether the conditions for issuance of the Substantial Completion Certificate have been satisfied, having regard for the opinions of both Project Co and Contracting Authority, to determine whether any Minor Deficiencies exist, and to issue to Contracting Authority and to Project Co either:
- (i) the Substantial Completion Certificate confirming the date of issue as the Substantial Completion Date and setting out the Minor Deficiencies List (if applicable) in accordance with Section 25.9; or
 - (ii) a report detailing the matters that the Independent Certifier considers are required to be performed by Project Co to satisfy the conditions for issuance of the Substantial Completion Certificate.
- (f) Where the Independent Certifier has issued a report in accordance with Section 25.4(e)(ii) and Project Co has not referred a Dispute in relation thereto for resolution in accordance with Schedule 27 – Dispute Resolution Procedure, Project Co shall, within five Business Days after receipt of such report, provide the Independent Certifier and the Contracting Authority Representative with:
- (i) a detailed list indicating the rectification actions proposed for all matters raised in such report;
 - (ii) the schedule for completion of all such rectification actions; and
 - (iii) any additional Project Co Commissioning that needs to be undertaken as a result of the rectification actions,
- and Project Co shall perform all such additional rectification actions and Project Co Commissioning in a timely manner. Upon completion thereof, and for each subsequent application for Substantial Completion, Project Co shall submit a new Substantial Completion 10-Day Notice and a new Substantial Completion Notice and the process described in Sections 25.4(c) to (f), inclusive, shall be repeated until the Substantial Completion Certificate has been issued.
- (g) In the event that the Substantial Completion Certificate has not been issued within 30 days after the delivery of a Substantial Completion 10-Day Notice or the delivery of a Substantial Completion Notice, such Substantial Completion 10-Day Notice or Substantial Completion Notice, as applicable, shall be deemed to have been rescinded by Project Co and Project Co shall be required to deliver a new Substantial Completion 10-Day Notice in order to initiate a new application for Substantial Completion.

- (h) For greater certainty, the Independent Certifier's decision to issue the IC Substantial Completion Deliverables Confirmation shall not limit or otherwise affect (i) any of Project Co's obligations under this Project Agreement to satisfy the requirements of Substantial Completion or (ii) the opinion of Contracting Authority or the determination of the Independent Certifier as to whether the conditions for issuance of the Substantial Completion Certificate have been satisfied pursuant to Section 25.4(d) and Section 25.4(e) respectively.
- (i) The Independent Certifier's decision to issue or not to issue the Substantial Completion Certificate shall be final and binding on the Parties solely in respect of determining the Substantial Completion Payment Date, and a Dispute in relation to the Substantial Completion Payment Date shall not be subject to resolution pursuant to the Dispute Resolution Procedure, provided, however, that any other Dispute in relation to the Independent Certifier's decision to issue or not to issue the Substantial Completion Certificate may be referred for resolution pursuant to the Schedule 27 – Dispute Resolution Procedure.
- (j) Project Co shall provide As Built Drawings, Record Drawings and specifications, Design Data, spare parts and Shop Drawings as soon as possible and in any event no later than 30 days after the Substantial Completion Date.
- (k) The submission of the Substantial Completion Notice by Project Co in accordance with Section 25.4(b) shall constitute a waiver by Project Co of all claims whatsoever against Contracting Authority under this Project Agreement, arising prior to the submission of the Substantial Completion Notice, except:
 - (i) without prejudice to specific notice requirements in this Project Agreement, those made in writing by Project Co (either on its own account or arising out of a claim of a Project Co Party) arising prior to the submission of the Substantial Completion Notice and still unsettled; and
 - (ii) any third party claim which was not known to Project Co or a Project Co Party or could not reasonably have been known to Project Co or a Project Co Party at such time and with respect to which Project Co or a Project Co Party is entitled to indemnification from Contracting Authority in accordance with this Project Agreement.

25.5 Operation and Maintenance Manuals

- (a) To the extent the same have not already been provided to the Contracting Authority pursuant to Section 24.5, Project Co shall prepare and deliver to Contracting Authority draft copies of all necessary operation and maintenance manuals for the New Metrolinx Infrastructure and the New Third Party Infrastructure in the format set out in the Output Specifications no later than 30 days prior to the Substantial Completion Date.

25.6 Maintenance Instructions

- (a) No later than 30 days prior to the Substantial Completion Date, Project Co shall prepare and deliver to Contracting Authority maintenance data in the format set out in the Output Specifications which is compatible with Contracting Authority's CMMS. The maintenance data shall detail all required planned activities (including, but not limited to, preventive maintenance) for the applicable portion of the Works prescribed by the applicable operation and maintenance

manuals and Good Industry Practice and shall be subject to the review and approval of Contracting Authority, acting reasonably. Following Contracting Authority's approval of such maintenance data, Contracting Authority shall upload it into the CMMS.

25.7 Contracting Authority Commissioning

- (a) The Parties acknowledge that Contracting Authority may perform Contracting Authority Commissioning both before and after the Substantial Completion Date. Prior to Substantial Completion, Project Co shall not restrict Contracting Authority, and any of its employees and subcontractors from full access to the Lands, the New Metrolinx Infrastructure and the New Third Party Infrastructure and all relevant parts thereof at such times as may be set out in the Final Commissioning Program to enable Contracting Authority to undertake any Contracting Authority Commissioning in accordance with the Final Commissioning Program. Contracting Authority shall comply, and shall ensure that all Contracting Authority Parties comply with the directions, procedures and safety guidelines established by Project Co for the Lands, the New Metrolinx Infrastructure and the New Third Party Infrastructure and shall use commercially reasonable efforts to minimize disruption to the Works in performing any Contracting Authority Commissioning.
- (b) Contracting Authority acknowledges that, during the Contracting Authority Commissioning Period, Project Co and its Subcontractors will be active on the Lands, the New Metrolinx Infrastructure and the New Third Party Infrastructure in both the completion and rectification of Minor Deficiencies and the completion of Project Co Commissioning, and Contracting Authority shall take commercially reasonable steps to allow such activities to proceed in accordance with the Final Commissioning Program.
- (c) Project Co acknowledges that, prior to and during the Contracting Authority Commissioning Period, Project Co and each Subcontractor shall cooperate with Contracting Authority and all other Province Persons and use commercially reasonable efforts to ensure that all requirements, and the timing and sequence of such requirements, of the Contracting Authority Commissioning activities are able to be completed in the timeframe for completion set out in the Final Commissioning Program.

25.8 Countdown Notice and Substantial Completion Deliverables

- (a) Project Co shall deliver a Notice (the "**Countdown Notice**") to Contracting Authority and the Independent Certifier specifying the date on which Project Co anticipates that Substantial Completion will be achieved (the "**Anticipated Substantial Completion Date**").
- (b) The Countdown Notice shall be delivered not less than 90 days prior to the Anticipated Substantial Completion Date. If Project Co fails to deliver the Countdown Notice not less than 90 days prior to the Scheduled Substantial Completion Date, the Anticipated Substantial Completion Date shall be deemed to be the same date as the Scheduled Substantial Completion Date.
- (c) Intentionally Deleted.
- (d) In accordance with Section 13.5(a), any Anticipated Substantial Completion Date shall not be earlier than the Scheduled Substantial Completion Date, without the prior written consent of Contracting Authority, in its sole discretion.

- (e) Within 15 Business Days of the Independent Certifier’s receipt of the Countdown Notice in accordance with Section 25.8(a), the Independent Certifier, in consultation with Project Co and Contracting Authority, shall prepare and deliver to Project Co and Contracting Authority a list of deliverables (the “**Substantial Completion Deliverables List**”) that (A) are to be appended to and form part of the Substantial Completion Notice to be submitted by Project Co pursuant to Section 25.4(b), and (B) will constitute a minimum amount of evidence necessary for Project Co, in the Substantial Completion Notice, to describe, in reasonable detail, the satisfaction of the requirements for Substantial Completion and to support Project Co’s opinion that the conditions for issuance of the Substantial Completion Certificate have been satisfied (collectively, the “**Substantial Completion Deliverables**”).
- (f) From time to time until the date that is 60 days prior to the Anticipated Substantial Completion Date, the Independent Certifier, in consultation with Project Co and Contracting Authority, may amend the Substantial Completion Deliverables List, including to set out any additional Substantial Completion Deliverables not identified in the Substantial Completion Deliverables List pursuant to Section 25.8(e). Each amended Substantial Completion Deliverables List shall, following its preparation, be deemed to be the Substantial Completion Deliverables List for the purposes of this Project Agreement and be promptly delivered to Project Co and Contracting Authority.
- (g) For greater certainty, nothing in Section 25.8(e) or Section 25.8(f) limits or otherwise affects any of Project Co’s obligations under this Project Agreement to satisfy the requirements of Substantial Completion or to describe, in reasonable detail, the satisfaction of such requirements in the Substantial Completion Notice pursuant to Section 25.4(b).

25.9 Minor Deficiencies

- (a) In the event that any Minor Deficiencies exist when Project Co gives a Substantial Completion Notice, the Independent Certifier, in consultation with Project Co and Contracting Authority, shall prepare a list of all Minor Deficiencies (the “**Minor Deficiencies List**”) identified at that time and an estimate of the cost for Contracting Authority and the time for Project Co, to complete and rectify such Minor Deficiencies. Contracting Authority may withhold from the Substantial Completion Payment a holdback amount that is [REDACTED]% of the amount estimated by the Independent Certifier for Contracting Authority,
 - (i) to complete and rectify all such Minor Deficiencies identified on the Minor Deficiencies List; and
 - (ii) to complete and rectify any Interim Completion Minor Deficiencies that have not been completed or rectified and that have been identified in any Interim Completion Minor Deficiencies List(such amount being the “**Completion Holdback**”), which holdback shall be held in an interest bearing account. For greater certainty, the amounts provided for in items (i) and (ii) of this Section 25.9(a) shall not be duplicative.
- (b) The Minor Deficiencies List will contain the schedule for the completion and rectification of the Minor Deficiencies. The timeframe for the completion or rectification of each Minor Deficiency shall be no later than six months following the Substantial Completion Date, other than for Minor

Deficiencies that are seasonal in nature and cannot be completed within six months following the Substantial Completion Date (“**Seasonal Minor Deficiencies**”). In determining the relevant time for rectifying Minor Deficiencies, Project Co shall schedule the completion and rectification of Minor Deficiencies so as to,

- (i) comply with the Access Management Plan and all rules, requirements and restrictions relating to access, rail safety and operations and track protection, all as set out in Schedule 15 – Output Specifications and Schedule 34 – Rail Corridor Access and Flagging; and
- (ii) minimize, to the greatest extent reasonably possible,
 - (A) any disruption of the Works or restrictions or other impairment of the public’s use and enjoyment of the New Metrolinx Infrastructure, the New Third Party Infrastructure, or any portion thereof; and
 - (B) any disruption of the operations of Contracting Authority, any Province Person, any Governmental Authority or any Other Contractor, including the performance of the Governmental Activities and the Other Works.
- (c) The Independent Certifier must prepare the Minor Deficiencies List in relation to the Substantial Completion Notice as soon as reasonably practicable, and, in any event, before the Substantial Completion Certificate is issued, but shall not withhold the Substantial Completion Certificate by reason solely that there are Minor Deficiencies.
- (d) No later than 20 Business Days prior to the Anticipated Final Completion Date, Contracting Authority may direct the Independent Certifier to amend, in consultation with Project Co and Contracting Authority, the Minor Deficiencies List on one occasion to include a list of any and all Minor Deficiencies that were identified after the preparation of, or not included in, the Minor Deficiencies List pursuant to Section 25.9(a). The Independent Certifier shall prepare the amended Minor Deficiencies List as soon as reasonably practicable and, in any event, within 10 Business Days after such direction given by Contracting Authority. The amended Minor Deficiencies List shall, following its preparation, be deemed to be the Minor Deficiencies List for the purposes of this Project Agreement, including for the purposes of Sections 25.9 to 25.10 inclusive. The amount of the Completion Holdback or the Seasonal Works Holdback, as applicable, shall not be affected by the amended Minor Deficiencies List.
- (e) Where the Independent Certifier has been directed by Contracting Authority to amend the Minor Deficiencies List pursuant to Section 25.9(d), the Independent Certifier shall specify a completion and rectification time for any newly added Minor Deficiencies that is no greater than 10 Business Days from the date of the issuance of such amended Minor Deficiencies List.
- (f) Contracting Authority may, in its sole discretion, waive any requirement for Substantial Completion, and the failure to meet any such requirement shall constitute a Minor Deficiency.

25.10 Completion and Rectification of Minor Deficiencies

- (a) Project Co shall, in consultation with the Contracting Authority Representative and so as to,

- (i) comply with the Access Management Plan and all rules, requirements and restrictions relating to access, rail safety and operations and track protection, all as set out in Schedule 15 – Output Specifications and Schedule 34 – Rail Corridor Access and Flagging; and
 - (ii) minimize, to the greatest extent reasonably possible,
 - (A) any disruption of the Works or restrictions or other impairment of the public’s use and enjoyment of the New Metrolinx Infrastructure, the New Third Party Infrastructure, or any portion thereof; and
 - (B) any disruption of the operations of Contracting Authority, any Province Person, any Governmental Authority or any Other Contractor, including the performance of the Governmental Activities and the Other Works,
- complete and rectify all Minor Deficiencies:
- (iii) within 45 days after the issuance of the Minor Deficiencies List pursuant to Section 25.9(a) for all Minor Deficiencies other than Seasonal Minor Deficiencies where no time for completion and rectification has been specified by the Independent Certifier;
 - (iv) within the time for completion and rectification of any Minor Deficiency where such a time was specified by the Independent Certifier in the Minor Deficiencies List;
 - (v) no later than six months following the Substantial Completion Date for all Minor Deficiencies other than Seasonal Minor Deficiencies; and
 - (vi) no later than six months following the Minor Deficiencies Completion Date for all Seasonal Minor Deficiencies.
- (b) Project Co acknowledges and agrees that the completion and rectification of Minor Deficiencies may require work outside of normal working hours in order to accommodate the efficient operation of the New Metrolinx Infrastructure, the New Third Party Infrastructure or any portion thereof and to ensure compliance with the Access Management Plan and all rules, requirements and restrictions relating to access, rail safety and operations and track protection, all as set out in Schedule 15 – Output Specifications and Schedule 34 – Rail Corridor Access and Flagging.

25.11 Failure to Rectify Minor Deficiencies

- (a) If Project Co fails to complete and rectify any Minor Deficiency within the time for its completion and rectification specified in Section 25.10, Contracting Authority may engage others to perform the work necessary to complete and rectify such Minor Deficiency at the risk and cost of Project Co, and Contracting Authority may deduct such cost from the Completion Holdback or the Seasonal Works Holdback, as applicable, and interest accrued thereon.
- (b) Where there exist incomplete or unrectified Seasonal Minor Deficiencies and all other Minor Deficiencies have been completed or rectified, within two Business Days after completion and rectification of all Minor Deficiencies other than Seasonal Minor Deficiencies (the “**Minor**

Deficiencies Completion Date”), Contracting Authority shall release to Project Co the amount of the Completion Holdback less:

- (i) a holdback amount that is the greater of:
 - (A) 200% of the amount estimated by the Independent Certifier pursuant to Section 25.9(a) for Contracting Authority to complete and rectify all remaining Seasonal Minor Deficiencies identified by the Independent Certifier; and
 - (B) 30% of the Completion Holdback,(the “**Seasonal Works Holdback**”), which holdback shall be held in an interest bearing account;
 - (ii) any amounts deducted in accordance with Section 25.11(a)), together with all interest accrued thereon and applicable HST; and
 - (iii) the amount of any Finishing Holdback required to be maintained by Contracting Authority as at such date, which Finishing Holdback amount shall be paid by Contracting Authority to Project Co in accordance with Section 4.6(d).
- (c) Within two Business Days after Final Completion, Contracting Authority shall release to Project Co the amount of the Completion Holdback or the Seasonal Works Holdback, as applicable (less any amounts deducted in accordance with Section 25.11(a)), together with all interest accrued thereon and applicable HST, less the amount of any Finishing Holdback required to be maintained by Contracting Authority as at such date, which Finishing Holdback amount shall be paid by Contracting Authority to Project Co in accordance with Section 4.6(d).
- (d) Where Contracting Authority exercises its rights pursuant to 25.11(a), if the cost of such completion and rectification exceeds the amount of the Completion Holdback or the Seasonal Works Holdback, as applicable, and interest, then Project Co shall reimburse Contracting Authority for all such excess cost.

25.12 Final Completion Countdown Notice

- (a) Project Co shall deliver a Notice (the “**Final Completion Countdown Notice**”) to Contracting Authority and the Independent Certifier specifying the date (which, for greater certainty, will be on or before the Scheduled Final Completion Date) on which Project Co anticipates that Final Completion will be achieved (the “**Anticipated Final Completion Date**”).
- (b) The Final Completion Countdown Notice shall be delivered not less than 60 days prior to the Anticipated Final Completion Date. If Project Co fails to deliver the Final Completion Countdown Notice not less than 60 days prior to the Scheduled Final Completion Date, the Anticipated Final Completion Date shall be deemed to be the same date as the Scheduled Final Completion Date.

25.13 Final Completion Certificate

- (a) Project Co shall give the Independent Certifier and the Contracting Authority Representative at least 10 Business Days' Notice prior to the date upon which Project Co anticipates delivering the Final Completion Notice.
- (b) Project Co shall give the Independent Certifier and the Contracting Authority Representative Notice (the "**Final Completion Notice**") upon the satisfaction of all requirements for Final Completion, which Final Completion Notice shall describe, in reasonable detail, the satisfaction of the requirements for Final Completion, including the completion and rectification of all Minor Deficiencies, together with Project Co's opinion as to whether the conditions for issuance of the Final Completion Certificate have been satisfied. The Final Completion Notice shall also include the following documentation:
 - (i) Project Co's written request for release of the Completion Holdback or the Seasonal Works Holdback, as applicable, including a declaration that no written notice of lien arising in relation to the performance of the Works has been received by it that has not been withdrawn by the lien claimant;
 - (ii) Project Co's Statutory Declaration CCDC 9A (2001);
 - (iii) Project Co's WSIB Certificate of Clearance; and
 - (iv) a written statement that the Works have been performed to the requirements of the Ancillary Documents, itemizing approved changes in the Works, the Independent Certifier's written instructions, and modifications required by Governmental Authorities.
- (c) Contracting Authority shall, within five Business Days after receipt of the Final Completion Notice, provide the Independent Certifier and Project Co with Contracting Authority's opinion as to whether the conditions for issuance of the Final Completion Certificate have been satisfied and, if applicable, any reasons as to why they consider that the Final Completion Certificate should not be issued.
- (d) Within five Business Days after Project Co's receipt of Contracting Authority's opinion pursuant to Section 25.13(c), the Parties shall cause the Independent Certifier to determine whether the conditions for issuance of the Final Completion Certificate have been satisfied, having regard for the opinions of both Project Co and Contracting Authority, and to issue to Contracting Authority and to Project Co either:
 - (i) the Final Completion Certificate confirming the date of issue as the Final Completion Date; or
 - (ii) a report detailing the matters that the Independent Certifier considers are required to be performed by Project Co to satisfy the conditions for issuance of the Final Completion Certificate, including any items on the Minor Deficiencies List which remain outstanding.
- (e) Where the Independent Certifier has issued a report in accordance with Section 25.13(d)(ii) and Project Co has not referred a Dispute in relation thereto for resolution in accordance with Schedule 27 – Dispute Resolution Procedure, Project Co shall, within five Business Days after

receipt of such report, provide the Independent Certifier and the Contracting Authority Representative with:

- (i) a detailed list indicating the rectification actions proposed for all matters raised in such report;
- (ii) the schedule for completion of all such rectification actions; and
- (iii) any additional Project Co Commissioning that needs to be undertaken as a result of the rectification actions,

and Project Co shall perform all such additional rectification actions in a timely manner. Upon completion thereof, Project Co may give a further Final Completion Notice and Sections 25.13(c) to 25.13(e), inclusive, shall be repeated until the Final Completion Certificate has been issued.

- (f) Any Dispute in relation to the Independent Certifier's decision to issue or not to issue the Final Completion Certificate may be referred for resolution in accordance with Schedule 27 – Dispute Resolution Procedure.
- (g) Intentionally Deleted.
- (h) The submission of the Final Completion Notice by Project Co in accordance with Section 25.13(b), shall constitute a waiver by Project Co of all claims whatsoever against Contracting Authority, arising prior to the submission of the Final Completion Notice, except:
 - (i) without prejudice to specific notice requirements in this Project Agreement, those made in writing by Project Co (either on its own account or arising out of a claim of a Project Co Party) prior to the Final Completion Notice and still unsettled; and
 - (ii) any third party claim which was not known to Project Co or a Project Co Party or could not reasonably have been known to Project Co or a Project Co Party at such time and with respect to which Project Co or a Project Co Party is entitled to indemnification from Contracting Authority in accordance with this Project Agreement.

25.14 Effect of Certificates/Use

- (a) The issue of a Substantial Completion Certificate or the Final Completion Certificate, the commencement of use by Contracting Authority or the public of any part of the New Metrolinx Infrastructure or New Third Party Infrastructure under the terms of this Project Agreement or the commencement of any Governmental Activities, shall, in no way:
 - (i) limit the obligations of Project Co under this Project Agreement including in respect of any defects, deficiencies or items of outstanding work existing or discovered prior to or after the date of any of such certificates or the date of the Minor Deficiencies List or of the amended Minor Deficiencies List described in Section 25.9(d); or
 - (ii) be construed as an approval by Contracting Authority of the Works or the way in which they have been carried out.

25.15 Inspection, Commissioning and Handover of [REDACTED]

- (a) Project Co acknowledges and agrees that [REDACTED] will be inspected, commissioned and handed over to the applicable third party owner upon completion of the [REDACTED].
- (b) For the purposes of this Section 25.15, Contracting Authority may delegate the responsibility for carrying out interim inspections, final inspections, warranty inspections, Interim Completion Contracting Authority Commissioning, Contracting Authority Commissioning, and Handover activities, on behalf of Contracting Authority, to the [REDACTED] by providing Notice to Project Co of any such delegation (any such Notice referred to as a “**Notice of Delegation**”), and Contracting Authority may, in its sole discretion, and at any time revise such delegation by Notice to Project Co. For clarity, Contracting Authority may delegate the foregoing responsibility in respect of all or any component of any applicable [REDACTED]. Project Co acknowledges and agrees that, for the purposes of this Section 25.15, Project Co shall Handover all [REDACTED] directly to Contracting Authority unless Contracting Authority has delivered to Project Co a Notice of Delegation in respect of [REDACTED], in which case, Project Co shall Handover such [REDACTED] directly to the [REDACTED].
- (c) No later than five days prior to the anticipated completion of [REDACTED], Project Co shall provide Notice to Contracting Authority or, where a Notice of Delegation has been provided to Project Co, Project Co shall provide Notice to [REDACTED] of the date on which the [REDACTED] will be completed and ready for inspection and testing. Project Co and Contracting Authority, or Project Co and the [REDACTED] (where a Notice of Delegation has been provided) shall carry out a joint inspection of such [REDACTED]. Such joint inspection shall occur no later than 90 days after the date of completion of the [REDACTED]. The inspection and testing of [REDACTED] pursuant to this Section 25.15(c) shall follow the inspection and testing requirements set out in the Inspection and Test Plan and the Inspection and Test Sub-Plans. Such inspection shall be for the purposes of:
 - (i) assessing whether the [REDACTED] has been constructed in accordance with the Output Specifications and is otherwise in compliance with the requirements in the Project Agreement; and
 - (ii) identifying any defects or deficiencies to the [REDACTED] that Project Co must correct, repair or restore before Project Co completes the Project Co Commissioning of the [REDACTED] before the Handover of the [REDACTED] to the [REDACTED].
- (d) Prior to final inspection of [REDACTED], Project Co shall:
 - (i) prepare a record of the following, and submit it to Contracting Authority for review in accordance with Schedule 10 – Review Procedure at least 30 Business Days before the final inspection:
 - (A) a list of the [REDACTED] to be inspected;
 - (B) the tests, inspection methods and procedures to be used and performed and the standards that apply in respect of tests, inspection methods and procedures, which test and inspection shall follow the inspection and testing requirements set out in the Inspection and Test Plan and the Inspection and Test Sub-Plans;

- (C) the scheduled date for testing and inspection of the applicable [REDACTED];
 - (D) a list of the names and employers of persons to represent Project Co and Contracting Authority or, if a Notice of Delegation has been issued in respect of the relevant [REDACTED], a list of the names and employers of persons to represent Project Co and [REDACTED] at the inspection; and
 - (E) a list of existing systems that may be impacted by the tests and inspection;
- (ii) ensure that:
- (A) all defects and deficiencies that have been identified by Contracting Authority [REDACTED], as applicable, during any interim inspections, have been rectified; and
 - (B) any damage to [REDACTED] is repaired by Project Co in accordance with Section 11.9 of this Project Agreement.
- (e) Project Co shall prepare a record of each inspection carried out pursuant to Section 25.15(c) in inspection report format including: (i) a list of defects or deficiencies to the [REDACTED] identified during the inspection; and (ii) actions to be taken by Project Co to correct each defect or deficiency and to rectify the damage. Project Co shall submit the inspection reports to Contracting Authority within three Business Days after each inspection for review in accordance with Schedule 10 – Review Procedure.
- (f) After the inspection of the [REDACTED] pursuant to Section 25.15(c), Project Co shall make all arrangements in respect of the applicable [REDACTED] to,
- (i) correct all defects and deficiencies to the applicable [REDACTED] and repair any damage to the [REDACTED];
 - (ii) complete Project Co Commissioning of the [REDACTED] in accordance with Schedule 14 – Outline Commissioning Program and Handover;
 - (iii) in respect of [REDACTED] only, comply with all requirements in respect of [REDACTED] set out in Appendix A of Schedule 14 – Outline Commissioning Program and Handover (including, for clarity, those set out in Attachment 1 of Appendix A) prior to, and as a pre-condition of Handover of [REDACTED];
 - (iv) complete Handover of the [REDACTED] to Contracting Authority or, where Contracting Authority has delivered to Project Co a Notice of Delegation in respect of [REDACTED], complete Handover to [REDACTED]; and
 - (v) seek, receive, and document confirmation from Contracting Authority or, where Contracting Authority has delivered to Project Co a Notice of Delegation in respect of the applicable [REDACTED], seek, receive, and document confirmation from [REDACTED], that such Project Co Commissioning and Handover has been completed.

- (g) Project Co shall provide Notice to Contracting Authority when Project Co has completed Project Co Commissioning and has achieved Handover of the [REDACTED] to [REDACTED]. Such Notice to Contracting Authority shall include the following:
- (i) a clear identification of the [REDACTED] that is the subject of the Notice;
 - (ii) the date of Handover of the applicable [REDACTED] (as set out in the written confirmation required by Section 25.15(g)(iii)); and
 - (iii) a written confirmation, signed by an authorized representative of [REDACTED] that Project Co Commissioning and Handover of the [REDACTED] has been completed, including the confirmed date of Handover.
- (h) [REDACTED] and the Contracting Authority, may,
- (i) at any time and from time to time, on providing 30 Business Days' Notice to Project Co, require a joint interim inspection of the [REDACTED] to be carried out for the purposes of:
 - (A) assessing whether the [REDACTED] has been constructed in accordance with the Output Specifications and is otherwise in compliance with the requirements of the Project Agreement; and
 - (B) identifying any defects or deficiencies to the applicable [REDACTED];
 - (ii) at any time and from time to time, on providing 30 Business Days' Notice to Project Co, require a joint warranty inspection to be carried out in respect of the [REDACTED] for the purpose of identifying any defects or deficiencies; and
- (i) In addition to the warranty inspections that may be performed from time to time pursuant to Section 25.15(h), a joint warranty inspection of [REDACTED] shall be carried out no earlier than 60 days and no later than 30 days prior to the end of the applicable Warranty Period for such [REDACTED].
- (j) In the event of a dispute between Project Co and Contracting Authority (including Contracting Authority as a representative of the interests of the [REDACTED]) with respect to final inspection, Project Co Commissioning or Handover of the [REDACTED], the following shall apply:
- (i) Project Co shall make commercially reasonable efforts to resolve all outstanding concerns of Contracting Authority and the [REDACTED] in a prompt manner;
 - (ii) any Project Co Commissioning or Handover issue that is unresolved after the expiration of 90 days after Project Co and Contracting Authority, or Project Co and the applicable third party owner (where a Notice of Delegation has been provided), have carried out the joint inspection pursuant to Section 25.15(c) shall be referred to the Independent Certifier for final determination on an expedited basis with such final determination being made no later than the earlier of (A) 60 days from the date of the referral; and (B) the Substantial Completion Date; and

- (iii) any Project Co Commissioning or Handover issue that is,
 - (A) unresolved as of the Countdown Notice issued pursuant to Section 25.8(a); or
 - (B) arises after the issuance of the Substantial Completion Countdown Notice issued pursuant to Section 25.8(a) and is not resolved,
- shall be referred to the Independent Certifier for final determination prior to the Scheduled Interim Completion Date or the Scheduled Substantial Completion Date, as applicable.

25A. MILESTONE PAYMENTS

25A.1 Milestone Payment Completion Countdown Notice

- (a) For each of the First Milestone Payment and Second Milestone Payment, Project Co shall deliver a notice (the “**Milestone Payment Completion Countdown Notice**”) to Contracting Authority and the Independent Certifier specifying the date on which Project Co anticipates the applicable requirements for Milestone Payment Completion shall be satisfied (the “**Anticipated Milestone Payment Completion Date**”).
- (b) Each Milestone Payment Completion Countdown Notice shall be delivered no later than 90 days prior to the applicable Scheduled Milestone Payment Completion Date. If Project Co fails to deliver a Milestone Payment Completion Countdown Notice not less than 90 days prior to the Scheduled First Milestone Payment Completion Date or the Scheduled Second Milestone Payment Completion Date, the applicable Anticipated Milestone Payment Completions Date shall be deemed to be the same date as the Scheduled First Milestone Payment Completion Date or the Scheduled Second Milestone Payment Completion Date, as applicable.
- (c) Project Co acknowledges and agrees that Contracting Authority requires a minimum of 90 days’ notice prior to each applicable Anticipated Milestone Payment Completion Date.

25A.2 Certification of Milestone Payments

- (a) Project Co shall give Contracting Authority and the Independent Certifier at least 10 Business Days’ notice prior to the date upon which Project Co anticipates the applicable requirements for Milestone Payment Completion shall be satisfied.
- (b) Project Co shall give Contracting Authority and the Independent Certifier notice (the “**Milestone Payment Completion Notice**”), upon the satisfaction of the applicable requirements for Milestone Payment Completion which shall describe, in reasonable detail, the satisfaction of requirements for Milestone Payment Completion, together with Project Co’s opinion as to whether the conditions for Milestone Payment Completion have been satisfied.
- (c) Contracting Authority shall, within five Business Days after receipt of each Milestone Payment Completion Notice, provide Project Co and the Independent Certifier with Contracting Authority’s opinion as to whether Project Co has satisfied the applicable requirement for Milestone Payment Completion for the First Milestone Payment or the Second Milestone Payment, as applicable, and, if applicable, any reasons as to why it considered that Project Co has not satisfied the applicable

requirements for Milestone Payment Completion for the First Milestone Payment or the Second Milestone Payment, as applicable.

- (d) Within five Business Days after Project Co's receipt of Contracting Authority's opinion pursuant to Section 25A.2(c), the Parties shall cause the Independent Certifier to determine whether the applicable requirements for Milestone Payment Completion for the First Milestone Payment or the Second Milestone Payment, as applicable, have been met, having regard to the opinions of both Project Co and Contracting Authority, and to issue to Contracting Authority and Project Co either:
- (i) a notice that the requirements for Milestone Payment Completion for the First Milestone Payment or the Second Milestone Payment, as applicable, have been met (the "**First Milestone Payment Completion Date**" or the "**Second Milestone Payment Completion Date**", as applicable); or
 - (ii) a report setting out the percentage of the Cost of the Work that the Independent Certifier considers remains to be completed in order to satisfy the applicable requirements for Milestone Payment Completion for the First Milestone Payment or the Second Milestone Payment, as applicable.
- (e) Where the Independent Certifier has issued a report in accordance with Section 25A.2(d)(ii), Project Co shall, within five Business Days after receipt of such report, provide the Independent Certifier and Contracting Authority with a letter which acknowledges the percentage of the Cost of the Work that remains to be completed (as set out in the Independent Certifier's report) to achieve the applicable requirements for Milestone Payment Completion and includes a schedule for completing such Work. Upon completion thereof, Project Co may give a further Milestone Payment Completion Notice and then Sections 25A.2(c) to (d), inclusive, shall be repeated until the Independent Certifier issues a notice pursuant to Section 25A.2(d)(i).
- (f) Where the Independent Certifier has issued a notice in accordance with Section 25A.2(d)(i), Contracting Authority shall make the First Milestone Payment or the Second Milestone Payment on the applicable Milestone Payment Date.

26. HUMAN RESOURCES

26.1 Admittance of Personnel

- (a) Contracting Authority shall have the right to order the removal from the Lands, the New Metrolinx Infrastructure or the New Third Party Infrastructure of any person employed by (or acting on behalf of) Project Co, or any Project Co Party, whose presence, in the reasonable opinion of Contracting Authority, is likely to have an adverse effect on the Other Works or the Governmental Activities or who, in the reasonable opinion of Contracting Authority, is not a fit and proper person to be on the Lands, the New Metrolinx Infrastructure or the New Third Party Infrastructure for any reason, including a failure to comply with any Contracting Authority policy or any immediate obligation of Contracting Authority to ensure the safety and well-being of persons on the Lands, the New Metrolinx Infrastructure and the New Third Party Infrastructure.

- (b) Any action taken under this Section 26.1 shall promptly be confirmed by Contracting Authority to Project Co and, for greater certainty, shall not relieve Project Co of any of its obligations under this Project Agreement.
- (c) Any decision of Contracting Authority made pursuant to this Section 26.1 shall be final and conclusive.

26.2 Staff Competency

- (a) Project Co shall ensure that:
 - (i) there shall at all times be a sufficient number of persons employed or engaged by Project Co or any Project Co Party (including all relevant grades of supervisory staff) engaged in the performance of the Works with the requisite level of skill and experience to perform the Works in accordance with this Project Agreement. For greater certainty, this obligation shall include ensuring that there are a sufficient number of such skilled and experienced persons employed or engaged by Project Co or any Project Co Party to complete the Works in accordance with the Project Works Schedules;
 - (ii) all persons employed or engaged by Project Co or any Project Co Party (including all relevant grades of supervisory staff) engaged in the performance of the Works receive such training and supervision as is necessary to ensure the proper performance of this Project Agreement and compliance with all health and safety rules, procedures and requirements, Authority Requirements and the Contracting Authority HR Policy; and
 - (iii) it creates and maintains, and causes all Project Co Parties to create and maintain, a process which allows it to assess, monitor and correct, on an ongoing basis, the competency of persons employed or engaged by Project Co or any Project Co Party (including all relevant grades of supervisory staff) engaged in the performance of the Works to ensure the proper performance of this Project Agreement.

26.3 Notification of Convictions

- (a) Project Co (to the extent permitted by Applicable Law) shall, and shall cause such Project Co Party to, ensure that all potential employees (including, for greater certainty, permanent, temporary, full time and part time employees) and persons who may otherwise perform the Works:
 - (i) are questioned concerning Relevant Convictions; and
 - (ii) are required to complete and deliver to Project Co a criminal records search form.
- (b) To the extent permitted by Applicable Law, Project Co shall, and shall cause each Project Co Party to, ensure that no person who discloses any Relevant Conviction, or who is found to have any Relevant Conviction following the completion of a criminal records search, in either case of which Project Co or a Project Co Party is aware or ought to be aware, is allowed access to the Lands, the New Metrolinx Infrastructure or the New Third Party Infrastructure to perform any Works, without the prior written consent of Contracting Authority, in its sole discretion.

- (c) To the extent permitted by Applicable Law, Project Co shall ensure that Contracting Authority is kept immediately notified and kept advised at all times of any person employed or engaged by Project Co or any Project Co Party in the provision of any of the Works who, subsequent to the commencement of such employment or engagement, (i) has been arrested or detained; (ii) receives a Relevant Conviction; or (iii) is charged with an offence that could lead to a Relevant Conviction (of which Project Co or a Project Co Party becomes aware or whose previous Relevant Convictions become known to Project Co or a Project Co Party). Project Co shall use commercially reasonable efforts to obtain, or to cause all Project Co Parties to obtain, all consents as may be required by Applicable Law or otherwise authorizing the disclosure of such information to Contracting Authority as contemplated in this Section 26.3.

26.4 Disciplinary Action

- (a) Contracting Authority, acting reasonably, may notify Project Co of any Project Co or Project Co Party employee who engages in misconduct or is incompetent or negligent in the performance of duties or whose presence or conduct on the Lands or at work is otherwise considered by Contracting Authority to be undesirable, to constitute a threat to the health and/or safety of any of the users of the Lands and/or System Users or which Contracting Authority considers may potentially compromise (i) Contracting Authority's reputation or integrity, or (ii) the nature of the public transit system in the Municipality or the Province of Ontario so as to affect public confidence in the public transit system in the Municipality, the Province of Ontario or the Project. Upon investigation, Project Co may institute, or cause the relevant Project Co Party to institute, disciplinary proceedings, which shall be in accordance with the requirements of Applicable Law, and shall advise Contracting Authority in writing of the outcome of any disciplinary action taken in respect of such person.

26.5 Human Resources Policies

- (a) Project Co shall ensure that there are set up and maintained by it and by all Project Co Parties, human resources policies and procedures covering all relevant matters relating to the Works (including, for example, health and safety). Project Co shall ensure that the terms and the implementation of such policies and procedures comply with Applicable Law, Authority Requirements, and Good Industry Practice and that they are published in written form and that copies of them (and any revisions and amendments to them) are directly issued to Contracting Authority and all Project Co Parties.

26.6 Management Organizations

- (a) Project Co shall provide, and shall ensure that all Project Co Parties provide, to Contracting Authority, as required to keep such information current, the names of the management teams responsible for the provision of the Works.

26.7 Governmental Authority

- (a) Project Co shall ensure that it and all Project Co Parties comply at all times with any regulations, policies or directions set by any Governmental Authority related to labour, employment and/or human resources.

27. CONTRACTING AUTHORITY'S REMEDIAL RIGHTS

27.1 Exercise of Remedial Rights

(a) Contracting Authority may exercise all rights set out in this Section 27 at any time and from time to time if:

(i) Contracting Authority, acting reasonably, considers that a breach by Project Co of any obligation under this Project Agreement, or any act or omission on the part of Project Co or any Project Co Party:

(A) does or can reasonably be expected to create a serious threat to the health, safety or security of any person, including any System Users or Province Person; or

(B) does or can reasonably be expected to materially prejudice the performance of any Governmental Activities;

(C) may potentially compromise Contracting Authority's reputation or integrity, or the nature of the public transit system in the Municipality or the Province of Ontario, so as to affect public confidence in that system or the Project,

provided that:

(D) in respect of a breach by Project Co of any obligation under this Project Agreement or any act or omission on the part of Project Co or any Project Co Party which can reasonably be expected to cause any of the consequences set out in Sections 27.1(a)(i)(A) and 27.1(a)(i)(B), Contracting Authority shall not exercise its rights under this Section 27 unless Project Co has failed to cure the relevant breach, act or omission within five Business Days after Notice from Contracting Authority or, if such breach, act or omission cannot reasonably be cured within such five Business Day period, Project Co thereafter fails to diligently and continuously pursue such cure and to cure such breach, act or omission within a reasonable period thereafter, provided that Project Co shall not be entitled to a cure period if any of the consequences set out in Sections 27.1(a)(i)(A) and 27.1(a)(i)(B) actually occur; and

(E) in respect of Section 27.1(a)(i)(C), Contracting Authority shall not exercise its rights under this Section 27 unless Project Co has failed to cure the relevant breach, act or omission within five Business Days after Notice from Contracting Authority or, if such breach, act or omission cannot reasonably be cured within such five Business Day period, Project Co thereafter fails to diligently and continuously pursue such cure and to cure such breach, act or omission within a reasonable period thereafter;

(ii) Project Co has not caused the COR-Qualified Construction Project Co Party or the COR-Certified Construction Project Co Party, as the case may be, to perform its obligations with respect to its COR Certification or OHSAS 18001 Accreditation, as the case may be, in accordance with Section 11.25, or Project Co has not caused the COR-Qualified Construction Project Co Party or the COR-Certified Construction Project

Co Party, as the case may be, to perform its obligations with respect to H&S Construction Inspections in accordance with Section 15.1(b), or to perform its obligations to rectify any non-compliance noted in any H&S Construction Inspection Report in accordance with Section 15.1(e);

- (iii) Project Co has not performed or is not performing its obligations in respect of the Demolition Requirements in accordance with Section 11.26 or Project Co has not performed or is not performing its obligations to rectify any Demolition Default Event in accordance with Section 11.26; or
- (iv) Project Co has failed to comply with any written direction issued by or on behalf of Contracting Authority.

27.2 Emergency

- (a) Notwithstanding that Project Co is not in breach of its obligations under this Project Agreement, Contracting Authority may exercise all of the rights set out in this Section 27 at any time and from time to time if Contracting Authority, acting reasonably, considers the circumstances to constitute an Emergency.

27.3 Rectification

- (a) Without prejudice to Contracting Authority's rights under Section 36 and any other rights under this Project Agreement, in any of the circumstances set out in Sections 27.1 or 27.2, Contracting Authority may, by written Notice, require Project Co to take such steps as Contracting Authority, acting reasonably, considers necessary or expedient to mitigate, rectify or protect against such circumstance, including, if applicable, the termination and replacement of Subcontractors or a limited suspension of the performance of the Works, and Project Co shall use commercially reasonable efforts to comply with Contracting Authority's requirements as soon as reasonably practicable.
- (b) If Contracting Authority gives Notice to Project Co pursuant to Section 27.3(a) and either:
 - (i) Project Co does not either confirm, within five Business Days after such Notice or such shorter period as is appropriate in the case of an Emergency that it is willing to take the steps required in such Notice or present an alternative plan to Contracting Authority to mitigate, rectify and protect against such circumstances that Contracting Authority may accept or reject acting reasonably; or
 - (ii) Project Co fails to take the steps required in such Notice or accepted alternative plan within such time as set out in such Notice or accepted alternative plan or within such longer time as Contracting Authority, acting reasonably, shall think fit,

then Contracting Authority may take such steps as it considers to be appropriate, acting reasonably, including requiring the termination and replacement of Subcontractors, either themselves or by engaging others (including a third party) to take any such steps.

- (c) Notwithstanding the foregoing provisions of this Section 27.3, in the event of an Emergency, the Notice under Section 27.3(a) shall be given as promptly as possible having regard to the nature of

the Emergency and Contracting Authority may, prior to Project Co's confirmation under Section 27.3(b)(i), take such steps as are appropriate having regard to the nature of the Emergency.

27.4 Costs and Expenses

- (a) Subject to Contracting Authority's obligations pursuant to Sections 27.5 and 27.6:
 - (i) Project Co shall bear all costs and expenses incurred by Project Co in relation to the exercise of Contracting Authority's rights pursuant to this Section 27; and
 - (ii) Project Co shall reimburse Contracting Authority for all reasonable costs and expenses incurred by Contracting Authority in relation to the exercise of Contracting Authority's rights pursuant to this Section 27, including in relation to Contracting Authority taking such steps, either itself or by engaging others (including a third party) to take any such steps as Contracting Authority considers appropriate and as are in accordance with this Section 27.

27.5 Reimbursement Events

- (a) In this Section 27.5, a "**Reimbursement Event**" means:
 - (i) an act or omission of Project Co or any Project Co Party or a breach by Project Co or any Project Co Party of any obligation under this Project Agreement, but only to the extent such act, omission or breach is caused by Contracting Authority or a Contracting Authority Party; or
 - (ii) an Emergency that is not caused or contributed to by an act or omission of Project Co or any Project Co Party or a breach by Project Co or any Project Co Party of any obligation under this Project Agreement.
- (b) If Contracting Authority either takes steps itself or requires Project Co to take steps in accordance with this Section 27 as a result of a Reimbursement Event:
 - (i) Contracting Authority shall reimburse Project Co for the reasonable costs and expenses incurred by Project Co in relation to the exercise of Contracting Authority's rights pursuant to this Section 27 that would not otherwise have been incurred by Project Co in the proper performance of its obligations under this Project Agreement; and
 - (ii) Contracting Authority shall bear all costs and expenses incurred by Contracting Authority in relation to the exercise of Contracting Authority's rights pursuant to this Section 27.

27.6 Reimbursement if Improper Exercise of Rights

- (a) If Contracting Authority exercises its rights pursuant to this Section 27, but Contracting Authority was not entitled to do so, Contracting Authority shall reimburse Project Co for the reasonable costs and expenses directly incurred by Project Co over and above those that would otherwise have been incurred by Project Co in the proper performance of its obligations under this Project Agreement and that are directly and reasonably incurred by Project Co in complying with those

written requirements of Contracting Authority issued as a result of Contracting Authority having exercised such rights.

- (b) Project Co acknowledges and agrees that Project Co has no right to require a determination of whether or not Contracting Authority is entitled to exercise its rights pursuant to this Section 27 before taking any such action that Contracting Authority may require and Project Co shall comply with all of Contracting Authority's requirements. Only concurrently with or after complying with Contracting Authority's requirements shall Project Co be entitled to refer any Dispute for resolution in accordance with Schedule 27 – Dispute Resolution Procedure.

28. RECORDS, INFORMATION AND AUDIT

28.1 Records Provisions

- (a) Project Co shall comply with Schedule 26 – Record Provisions.

28.2 Information and General Audit Rights

- (a) Project Co shall provide, and shall cause each Subcontractor to provide, to Contracting Authority all information, reports, documents, records and the like, including as referred to in Schedule 26 – Record Provisions, in the possession of, or available to, Project Co as Contracting Authority may reasonably require from time to time for any purpose in connection with this Project Agreement, other than Sensitive Information. Project Co shall use commercially reasonable efforts to ensure that, for such purpose, all such information, reports, documents, records and the like in the possession of, or available to, the Construction Contractor shall be available to Project Co and Project Co shall include relevant terms in all Subcontracts to this effect.
- (b) Project Co shall also provide to Contracting Authority, and shall require each Subcontractor, including the Construction Contractor, to provide to Contracting Authority (at Contracting Authority's reasonable cost), all information, reports, documents, records and the like required to be provided pursuant to Section 28.2(a) which subsequently come into the possession of, or become available to, Project Co or each Subcontractor, as Contracting Authority may reasonably require from time to time to enable Contracting Authority to provide reports, notices, returns and the like pursuant to Applicable Law, including information and documentation pertaining to the physical condition of the Lands, the New Metrolinx Infrastructure and the New Third Party Infrastructure, security, health and safety, fire safety, emergency preparedness, environmental matters, employees and human resources related matters, other than Sensitive Information.
- (c) Project Co shall promptly after receipt provide Contracting Authority with a copy of any material notice, order, direction, requirement or other similar communication received by it or by any Subcontractor from any Governmental Authority in relation to any of the Works, the Lands, the New Metrolinx Infrastructure and the New Third Party Infrastructure, and Project Co shall include relevant terms in all Subcontracts to this effect.
- (d) Project Co shall promptly notify Contracting Authority of any actions, suits, proceedings, or investigations commenced, pending or threatened against Project Co or, to Project Co's knowledge, any Subcontractor at law or in equity before any Governmental Authority or arbitral body (whether or not covered by insurance) that individually or in the aggregate could result in any material adverse effect on the business, properties, or assets or the condition, financial or

- otherwise, of Project Co or in any impairment of its ability to perform its obligations under this Project Agreement.
- (e) All information, reports, documents and records in the possession of, or available to, Project Co, including as referred to in Schedule 26 – Record Provisions, which are required to be provided to or available to Contracting Authority hereunder, shall be subject and open to inspection and audit by Contracting Authority at any time and from time to time, which inspection and audit shall take place during normal business hours and at Project Co’s normal places of business unless Contracting Authority and Project Co otherwise agree. Contracting Authority shall also have the right to monitor and audit the performance of any and all parts of the Works wherever located, and Project Co shall cooperate with, and shall require each Subcontractor to cooperate with, and provide access to the representatives of Contracting Authority monitoring and auditing such parts of the Works, including providing them with access and copies (at Contracting Authority’s reasonable cost) of all relevant information, reports, documents and records pertaining to the performance of such parts of the Works. Except as otherwise provided herein, all of Contracting Authority’s costs for the inspections, audits and monitoring shall be borne by Contracting Authority.
 - (f) In conducting an audit of Project Co under Section 28.2(e) or as otherwise provided under this Project Agreement, Contracting Authority shall have all rights necessary or incidental to conducting an audit, including the right to have access to and inspect and take copies (at Contracting Authority’s reasonable cost) of all books and records of Project Co required to be provided to or available to Contracting Authority hereunder, upon reasonable Notice and at reasonable times. Project Co shall fully cooperate with Contracting Authority and its auditors in the conduct of any audits, including by making available all such records and accounts (other than Sensitive Information) in existence at that time as they may require to perform a full and detailed audit, and Project Co further agrees to promptly review and settle with Contracting Authority all matters arising from such audits, including the refunding of monies to Contracting Authority where applicable. At the reasonable request of Contracting Authority’s auditors, Project Co shall provide such information, reports, documents and records as Contracting Authority’s auditors may reasonably require, other than Sensitive Information.
 - (g) Contracting Authority’s rights pursuant to this Section 28.2 shall be in addition to, and shall not limit, any other audit, information, inspection or similar rights under this Project Agreement.
 - (h) Contracting Authority’s rights pursuant to this Section 28.2 shall not limit or restrict any Governmental Authority’s right of review, audit, information or inspection under Applicable Law. Contracting Authority’s right pursuant to this Section 28.2 may also be exercised by the Auditor General of Ontario, Her Majesty the Queen in right of Canada and the Auditor General of Canada without the requirement for further action on the part of Contracting Authority.
 - (i) Without limiting the generality of Section 28.2(a) and subject to Sections 42.1(a) and 42.3, in the event that Contracting Authority is required to provide information, including financial information, in relation to the Project, to the Province for corporate or financial reporting purposes, Project Co shall provide such information to Contracting Authority as Contracting Authority may reasonably require in order to comply with its corporate or financial reporting obligations. Project Co acknowledges and agrees that such information may include Sensitive Information.

28.3 Lenders' Consultant Reports

- (a) Project Co shall cause the Lenders' Agent to cause, in accordance with Section 5(j) of Schedule 4 – Lenders' Direct Agreement, the Lenders' Consultant to provide Contracting Authority a copy of any written assessment or report of the Works under the Design and Construction Contract, including but not limited to, any certificate of payment, concurrently with its delivery to the Lenders' Agent.

29. COMMUNICATIONS

29.1 Communications

- (a) Each of the Parties shall comply with Schedule 18 – Communication and Public Engagement Protocol.

30. CHANGES IN LAW

30.1 Performance after Change in Law

- (a) Following any and all Changes in Law, Project Co shall perform the Works in accordance with the terms of this Project Agreement, including in compliance with Applicable Law.

30.2 Works Change in Law

- (a) On the occurrence of a Works Change in Law:
 - (i) either Party may give Notice to the other of the need for a Variation as a result of such Works Change in Law;
 - (ii) the Parties shall meet within 10 Business Days after such Notice to consult with respect to the effect of the Works Change in Law and to reach an agreement on whether a Variation is required as a result of such Works Change in Law, and, if the Parties have not, within 10 Business Days after this meeting, reached an agreement, either Party may refer the question of whether a Works Change in Law has occurred or the effect of any Works Change in Law for resolution in accordance with Schedule 27 – Dispute Resolution Procedure; and
 - (iii) Contracting Authority shall, within 10 Business Days after agreement or determination that a Variation is required, issue a Variation Enquiry and the relevant provisions of Schedule 22 – Variation Procedure shall apply except that:
 - (A) Project Co may only object to any such Variation Enquiry on the grounds that the implementation of the Variation would not enable it to comply with the Works Change in Law;
 - (B) Project Co shall be responsible for obtaining all Development Approvals and Project Co Permits, Licences, Approvals and Agreements required in respect of the Variation;

- (C) Contracting Authority shall not be entitled to withdraw any such Variation Enquiry unless the Parties otherwise agree;
- (D) Project Co shall proceed to implement the Variation within such period as will enable it to comply with the Works Change in Law as soon as reasonably practicable; and
- (E) Project Co shall not be entitled to any payment or other compensation or relief from performance of its obligations under this Project Agreement in respect of any Works Change in Law or associated Variation other than as established pursuant to Schedule 22 – Variation Procedure.

30.3 Relevant Change in Law

- (a) On the occurrence of a Relevant Change in Law, either Party shall be entitled to seek compensation for any increase or decrease (as the case may be) in the net cost to Project Co of performing the Works so as to put such Party in no better and no worse position than it would have been in had the Relevant Change in Law not occurred. Any such compensation shall be calculated in accordance with this Section 30.3.
- (b) On the occurrence of a Relevant Change in Law:
 - (i) either Party may give Notice to the other of the need for a Variation as a result of such Relevant Change in Law;
 - (ii) the Parties shall meet within 10 Business Days after such Notice to consult with respect to the effect of the Relevant Change in Law and to reach an agreement on whether a Variation is required as a result of such Relevant Change in Law, and, if the Parties have not, within 10 Business Days after this meeting, reached an agreement, either Party may refer the question of whether a Relevant Change in Law has occurred or the effect of any Relevant Change in Law for resolution in accordance with Schedule 27 – Dispute Resolution Procedure; and
 - (iii) Contracting Authority shall, within 10 Business Days after agreement or determination that a Variation is required, issue a Variation Enquiry and the relevant provisions of Schedule 22 – Variation Procedure shall apply except that:
 - (A) Project Co may only object to any such Variation Enquiry on the grounds that the implementation of the Variation would not enable it to comply with the Relevant Change in Law;
 - (B) Project Co shall be responsible for obtaining all Development Approvals and Project Co Permits, Licences, Approvals and Agreements required in respect of the Variation;
 - (C) Contracting Authority shall not be entitled to withdraw any such Variation Enquiry unless the Parties otherwise agree;

- (D) Project Co shall proceed to implement the Variation within such period as will enable it to comply with the Relevant Change in Law as soon as reasonably practicable;
 - (E) the Parties shall, without prejudice to their respective general obligations to comply with the terms of this Project Agreement:
 - (I) use commercially reasonable efforts to mitigate the adverse effects of any Relevant Change in Law and take commercially reasonable steps to minimize any increase in costs arising from such Relevant Change in Law; and
 - (II) use commercially reasonable efforts to take advantage of any positive or beneficial effects of any Relevant Change in Law and take commercially reasonable steps to maximize any reduction in costs arising from such Relevant Change in Law; and
 - (F) any entitlement to compensation payable shall be in accordance with this Section 30.3, and any calculation of compensation shall take into consideration, inter alia:
 - (I) any failure by a Party to comply with Section 30.3(b)(iii)(E);
 - (II) any increase or decrease in its costs resulting from such Relevant Change in Law; and
 - (III) any amount which Project Co recovers under any insurance policy (or would recover if it complied with its obligations to insure under this Project Agreement or the terms of any policy of insurance required under this Project Agreement) which amount, for greater certainty, shall not include the amount of any excess or deductibles or any amount above the maximum insured amount applicable to any such insurance policy.
- (c) Project Co shall not be entitled to any payment or compensation or, except as provided in Section 32 or otherwise in this Project Agreement, relief in respect of any Relevant Change in Law, or the consequences thereof, other than in accordance with this Section 30.3, and Section 33 shall be construed accordingly.

31. VARIATIONS

31.1 Variation Procedure

- (a) Except as otherwise expressly provided in this Project Agreement, Schedule 22 – Variation Procedure shall apply in respect of Variations.
- (b) For greater certainty, Project Co shall, subject to and in accordance with Schedule 22 – Variation Procedure, be entitled to a Variation if a written direction issued by or on behalf of Contracting Authority to Project Co or any Project Co Party results in a variation, addition, reduction,

substitution, omission, modification, deletion, removal or other change to the whole or any part of the Works.

- (c) Without limiting Project Co's obligations pursuant to Section 11.10(a) and Schedule 22 – Variation Procedure, Project Co shall include in each Subcontract, and shall cause each Project Co Party to comply with, the Variation Procedure, to the extent that the Variation Procedure requires Project Co to minimize the cost and impact of Variations.

31.2 Innovation and Value Engineering

- (a) Project Co acknowledges that Contracting Authority at all times desires to reduce the overall cost to Contracting Authority of the Project, and Project Co agrees to cooperate, explore and work with Contracting Authority in investigating and considering innovation and value engineering and other cost saving measures.
- (b) If an innovation and value engineering proposal is at any time and from time to time originated and initiated solely by Project Co, Project Co may make a proposal (the "**Innovation Proposal**") by Notice to Contracting Authority.
- (c) The Parties agree that the subject of an Innovation Proposal shall not include:
 - (i) any Variation Enquiry initiated by Contracting Authority;
 - (ii) any Variation resulting from a Change in Law; or
 - (iii) any change to the Contracting Authority Activities.
- (d) The Innovation Proposal must:
 - (i) set out sufficient detail to enable Contracting Authority to evaluate the Innovation Proposal in full;
 - (ii) specify Project Co's reasons and justification for proposing the Innovation Proposal;
 - (iii) request Contracting Authority to consult with Project Co with a view to deciding whether to agree to the Innovation Proposal and, if so, what consequential changes Contracting Authority requires as a result;
 - (iv) indicate any implications of the Innovation Proposal, including a difference between the existing and the proposed requirements of this Project Agreement, and the comparative advantages of each to Project Co and Contracting Authority;
 - (v) indicate if there are any dates by which a decision by Contracting Authority must be made;
 - (vi) indicate the capital cost of the Innovation Proposal, including the cost of financing; and
 - (vii) include such other information and documentation as may be reasonably requested by Contracting Authority to fully evaluate and consider the Innovation Proposal.

- (e) Contracting Authority shall, acting in good faith, evaluate the Innovation Proposal, taking into account all relevant issues, including whether:
- (i) the Innovation Proposal affects the quality of the Works, the New Metrolinx Infrastructure, the New Third Party Infrastructure, or the likelihood of successful completion of the Works;
 - (ii) the Innovation Proposal will benefit or interfere with the efficient operation of the New Metrolinx Infrastructure, the New Third Party Infrastructure or the performance of the Contracting Authority Activities;
 - (iii) the Innovation Proposal will interfere with the relationship between Contracting Authority and third parties;
 - (iv) the financial strength of Project Co is sufficient to deliver the changed Works, as applicable;
 - (v) the residual value of the New Metrolinx Infrastructure, or the New Third Party Infrastructure is affected;
 - (vi) the Innovation Proposal materially affects the risks or costs to which Contracting Authority is exposed; or
 - (vii) any other matter Contracting Authority considers relevant.
- (f) Contracting Authority may request clarification or additional information regarding the Innovation Proposal, and may request modifications to the Innovation Proposal.
- (g) Contracting Authority may, in its sole discretion, accept or reject any Innovation Proposal.
- (h) If Contracting Authority accepts the Innovation Proposal, with or without modification, the relevant Innovation Proposal shall be documented and evidenced by a written Variation Confirmation, together with any other documents necessary to amend this Project Agreement or any relevant Project Documents to give effect to the Innovation Proposal.
- (i) If, after taking into account the agreed implementation and reasonably allocated development costs incurred by Project Co in connection with the Innovation Proposal and any other uses of the Innovation Proposal by Project Co, the Innovation Proposal causes or will cause the costs of Project Co and/or of a Subcontractor to decrease, the net savings in the costs of Project Co and/or the Subcontractor will be shared equally by Project Co and Contracting Authority, and Contracting Authority's share of the net savings shall, if the Parties agree, be reflected in a lump sum payment.
- (j) If an Innovation Proposal causes or will cause the costs of Contracting Authority to decrease, the net savings in the costs of Contracting Authority will be shared:
- (i) equally by Project Co and Contracting Authority following the implementation of the Innovation Proposal until the Termination Date; and

- (ii) thereafter, Contracting Authority shall be entitled to the full benefit of the net savings in costs (if applicable),

and Project Co's share of the net savings shall be reflected in a lump sum payment.

32. DELAY EVENTS

32.1 Definition

- (a) For the purposes of this Project Agreement, "**Delay Event**" means any of the following events or circumstances only to the extent, in each case, that it causes a delay in achieving either Interim Completion by the Scheduled Interim Completion Date or Substantial Completion by the Scheduled Substantial Completion Date, as applicable:
 - (i) the implementation of a Variation to the extent that Project Co has identified such delay in its Estimate and such delay has been documented in the Variation Confirmation;
 - (ii) subject to compliance by Project Co with the provisions of Section 11.12, damage, costs or delays from the execution of Additional Works by Additional Contractors, as applicable, in the circumstances described in Section 11.12(f);
 - (iii) a requirement that Project Co perform obligations under an Encumbrance pursuant to Section 17.2(c)(iii) or Section 17.2(d), which performance imposes costs or delays in the performance of the Works;
 - (iv) any breach by Contracting Authority of any of Contracting Authority's obligations under this Project Agreement (including, subject to Section 16.8 and Section 32.2(o), any delay by Contracting Authority in giving access to the Metrolinx Lands pursuant to Section 16.1(a), any obstruction of the rights afforded to Project Co under Section 16.1(a) or any delay by Contracting Authority in carrying out its obligations set forth in Schedule 10 – Review Procedure), except to the extent that any such breach is caused, or contributed to, by Project Co or any Project Co Party;
 - (v) a requirement pursuant to Section 18.2(e) or Section 18.2(g) for Project Co to perform any alteration, addition, Demolition, extension or variation in the Works, or to suspend or delay performance of the Works, upon the discovery of Contamination, which alteration, addition, Demolition, extension or variation in the Works, or suspension or delay in the performance of the Works, would not otherwise be required under this Project Agreement;
 - (vi) a requirement pursuant to Section 18.3(c)(ii)(A) or Section 18.3(d) for Project Co to perform any alteration, addition, Demolition, extension or variation in the Works, or to suspend or delay performance of the Works, upon the discovery of any fossils, artifacts or other objects having artistic, historic, archaeological or monetary value, including human remains and burial sites, which alteration, addition, Demolition, extension or variation in the Works or suspension or delay in performance of the Works, or would not otherwise be required under this Project Agreement;
 - (vii) a requirement pursuant to Section 18.4 for Project Co to perform any alteration, addition, demolition, extension or variation in the Works, or to suspend or delay performance of

the Works, upon the discovery of Unknown Utility Infrastructure pursuant to Section 18.4 which alteration, addition, demolition, extension or variation in the Works, or suspension or delay in the performance of the Works, would not otherwise be required under this Project Agreement;

- (viii) an uncovering of the Works pursuant to Section 20.3 where such Works are not subsequently found to be defective or not in compliance with the requirements of this Project Agreement (including the Output Specifications, the Project Co Proposal Extracts and the Design Data), unless such opening up of the Works was reasonable in the light of other defects or non-compliance previously discovered by Contracting Authority in respect of the same or a similar component of the Works or subset of the Works;
- (ix) a delay or cancellation of a Rail Corridor Access Permit related to a Track Protection Barrier Access or Track Protection Access if the delay or cancellation is equal to or exceeds [REDACTED] per cent of the total planned duration for Rail Corridor Access under the applicable Track Protection Confirmation (measured from the date and time set out in the Track Protection Confirmation), in accordance with Section 8.1(a)(i)(B) of Schedule 34 – Rail Corridor Access and Flagging;
- (x) a delay or cancellation of a Rail Corridor Access Permit related to a Minor Track Closure if the delay or cancellation is equal to or exceeds [REDACTED] per cent of the total planned duration for the Rail Corridor Access under the applicable Rail Corridor Access Permit or Track Protection Confirmation (measured from the date and time set out in the Track Protection Confirmation), in accordance with Section 8.1(a)(ii)(B) of Schedule 34 – Rail Corridor Access and Flagging;
- (xi) a delay or cancellation of a Rail Corridor Access Permit or Track Protection Confirmation related to a Major Track Closure in accordance with Section 8.1(a)(iii) of Schedule 34 – Rail Corridor Access and Flagging;
- (xii) a requirement pursuant to Section 11.1 of Schedule 27 – Dispute Resolution Procedure for Project Co to proceed in accordance with the direction of Contracting Authority during the pendency of a Dispute, which Dispute is subsequently determined in Project Co's favour;
- (xiii) any change to the terms, conditions or requirements of the Environmental Assessments, except in each case to the extent resulting from any change by Project Co in the design of the Project or from any other act or omission on the part of Project Co;
- (xiv) subject to compliance with Section 11.30(a), failure by a Category 1 Utility Company to perform any portion of the Category 1 Utility Work in accordance with the requirements and assumptions set out in the Final Utility Baseline Document (including, for clarity, the durations set out in the Final Utility Baseline Document for the Category 1 Utility Work), provided, in each case, that such failure does not arise (directly or indirectly) as a result of any act of omission of any Project Co Party.
- (xv) a Relief Event;
- (xvi) an event of Force Majeure;

- (xvii) a Relevant Change in Law;
 - (xviii) subject to compliance with Section 11.30(a), the City's failure to issue to Project Co a final determination in respect of a Listed Project Co PLAA as set out and subject to Section 11.8(e);
 - (xix) subject to compliance with Section 11.30(a), TTC's failure to issue to Project Co a final determination in respect of a Listed Project Co PLAA as set out and subject to Section 11.8(g);
 - (xx) an Additional Train Movement requires Project Co to perform any alteration, addition, Demolition, extension or variation in the Works, or to suspend or delay performance of the Works as a result of such Additional Train Movement in accordance with and subject to Section 8.2(a) and 8.2(b) of Schedule 34 – Rail Corridor Access and Flagging; or
 - (xxi) a requirement for Project Co or any Project Co Party to exit from the Rail Corridor as a result of an Emergency Rail Situation, provided the Emergency Rail Situation did not arise as a result of an act or omission of Project Co or any Project Co Party, in accordance with Section 10.1(b) of Schedule 34 – Rail Corridor Access and Flagging.
- (b) For clarity, in respect of Section 32.1(a)(xiv), a failure by a Category 1 Utility Company to perform the obligations set out in Section 32.1(a)(xiv) shall not, in any event, be cause for a Delay Event unless Project Co has,
- (i) fully complied with its obligations pursuant to the applicable Utility Agreement and the Final Baseline Utility Document;
 - (ii) properly coordinated the work being performed by the applicable Category 1 Utility Company with the Works; and
 - (iii) provided sufficient access to Site to the applicable Category 1 Utility Company for the purposes of carrying out the Category 1 Utility Work.
- (c) For further clarity, Section 32.1(a)(xiv) does not apply in respect of,
- (i) Category 1 Utility Companies in circumstances other than those specifically set out in Section 32.1(a)(xiv);
 - (ii) Category 2 Utility Companies, including failures of a Category 2 Utility Company to perform in accordance with the applicable Utility Agreement;
 - (iii) Works carried out by Project Co or Project Co Parties or goods or services provided by Project Co or Project Co Parties to the Utility Companies; or
 - (iv) any New Metrolinx Infrastructure or New Third Party Infrastructure (other than the New Utility Company Infrastructure).

32.2 Consequences of a Delay Event

- (a) Project Co shall provide written Notice to the Contracting Authority Representative and the Independent Certifier within five Business Days after becoming aware of the occurrence of any event or circumstances described in Section 32.1(a)(ii), Section 32.1(a)(iii), Section 32.1(a)(iv), Section 32.1(a)(v), Section 32.1(a)(vi), Section 32.1(a)(vii), Section 32.1(a)(viii), Section 32.1(a)(ix), Section 32.1(a)(x), Section 32.1(a)(xi), Section 32.1(a)(xiii), Section 32.1(a)(xiv), Section 32.1(a)(xx), or Section 32.1(a)(xxi) which, at the time of its occurrence, is reasonably likely to form the basis of a future claim by Project Co for relief under Section 32.2(e) as a Delay Event.
- (b) Project Co shall, within 10 Business Days (or such longer period of time as the Parties may agree) after delivering such notification under Section 32.2(a), provide further written details to the Contracting Authority Representative and the Independent Certifier which shall include:
- (i) identification of the category of Delay Event on which Project Co's future claim for relief would be based if such event or circumstances were to form the basis of a claim for relief as a Delay Event;
 - (ii) details of the event or circumstances forming the basis of Project Co's notification under Section 32.2(a);
 - (iii) details of the contemporary records which Project Co shall thereafter maintain to substantiate its claim for extra time if the event or circumstances detailed in accordance with Section 32.2(b)(ii) forms the basis of a future claim by Project Co for relief as a Delay Event;
 - (iv) details of the consequences (whether direct or indirect, financial or non-financial) that such event or circumstances may have upon the Scheduled Interim Completion Date and/or the Scheduled Substantial Completion Date, if such event or circumstances forms the basis of a future claim by Project Co for relief as a Delay Event; and
 - (v) details of any measures that Project Co proposes to adopt to prevent such event or circumstances from forming the basis of a future claim by Project Co for relief as a Delay Event or to mitigate the consequences of such claim if such event or circumstances were to become a Delay Event.
- (c) As soon as possible but in any event within three Business Days after Project Co receiving, or becoming aware of, any supplemental information pertaining to the event or circumstances disclosed in Section 32.2(a), Project Co shall submit further particulars based on such information to the Contracting Authority Representative and the Independent Certifier.
- (d) The Contracting Authority Representative shall, after receipt of written details under Section 32.2(b), or of further particulars under Section 32.2(c), be entitled by written Notice to require Project Co to provide such further supporting particulars as the Contracting Authority Representative may reasonably consider necessary. Project Co shall afford the Contracting Authority Representative and the Independent Certifier reasonable facilities for their investigations, including on-site inspection.

- (e) In addition to complying with its obligations under Sections 32.2(a) and 32.2(b), Project Co shall provide written Notice to the Contracting Authority Representative and the Independent Certifier within five Business Days after becoming aware that an event or circumstances has satisfied, or will satisfy, in the opinion of Project Co, the applicable definition of a Delay Event. Project Co shall, within 10 Business Days after such notification, provide further written details of the Delay Event to the Contracting Authority Representative and the Independent Certifier, including, if and as applicable, to substitute or supplement the information given in Sections 32.2(a), 32.2(b) and 32.2(c), to substantiate or support Project Co's claim which shall include, to the extent not previously provided:
- (i) a statement of which Delay Event upon which the claim is based;
 - (ii) details of the circumstances from which the Delay Event arises;
 - (iii) details of the contemporary records which Project Co shall maintain to substantiate its claim for extra time;
 - (iv) details of the consequences (whether direct or indirect, financial or non-financial) which such Delay Event may have upon the Scheduled Interim Completion Date and/or the Scheduled Substantial Completion Date, including a critical path analysis of the event or circumstances indicating the impact upon the Scheduled Interim Completion Date and/or the Scheduled Substantial Completion Date and;
 - (v) details of any measures which Project Co proposes to adopt to mitigate the consequences of such Delay Event.
- (f) As soon as possible, but in any event within three Business Days after Project Co receiving, or becoming aware of, any supplemental information which may further substantiate or support Project Co's claim under Section 32.2(e), Project Co shall submit further particulars based on such information to the Contracting Authority Representative and the Independent Certifier.
- (g) The Contracting Authority Representative shall, after receipt of written details under Section 32.2(e), or of further particulars under Section 32.2(f), be entitled by written Notice to require Project Co to provide such further supporting particulars as the Contracting Authority Representative may reasonably consider necessary. Project Co shall afford the Contracting Authority Representative and the Independent Certifier reasonable facilities for investigating the validity of Project Co's claim, including on-site inspection.
- (h) Subject to the provisions of this Section 32, the Contracting Authority Representative shall allow Project Co an extension of time equal to the delay caused by the Delay Event and shall fix (A) a revised Scheduled Interim Completion Date; (B) a revised Scheduled Substantial Completion Date; or (C) a revised Scheduled Final Completion Date, as applicable, as soon as reasonably practicable and in any event within 10 Business Days following the later of:
- (i) the date of receipt by the Contracting Authority Representative of Project Co's Notice given in accordance with Section 32.2(e) and the date of receipt of any further particulars (if such are required under Section 32.2(f)), whichever is later; and

- (ii) the date of receipt by the Contracting Authority Representative of any supplemental information supplied by Project Co in accordance with Section 32.2(f) and the date of receipt of any further particulars (if such are required under Section 32.2(g)), whichever is later.
- (i) For the avoidance of doubt, there shall be no extension to the Project Term as a result of any delay caused by a Delay Event.
- (j) If:
 - (i) the Contracting Authority Representative declines to fix (A) a revised Interim Completion Date; (B) a revised Scheduled Substantial Completion Date; or (C) a revised Scheduled Final Completion Date, as applicable;
 - (ii) Project Co considers that a different (A) Scheduled Interim Completion Date; (B) Scheduled Substantial Completion Date, or (C) Scheduled Final Completion Date should be fixed; or
 - (iii) there is a dispute as to whether a Delay Event has occurred,then Project Co shall be entitled to refer the matter for determination by the Independent Certifier. The decision of the Independent Certifier may be disputed by either Party and referred for resolution in accordance with Schedule 27 – Dispute Resolution Procedure.
- (k) To the extent that Project Co does not comply with its obligations under Sections 32.2(a), (b), (c), (d), (e), (f) or (g), and subject to Section 32.2(l), such failure shall be taken into account in determining Project Co’s entitlement to relief pursuant to this Section 32.
- (l) If Project Co does not provide further written details to the Contracting Authority Representative and the Independent Certifier as required under Section 32.2(b) within the 10 Business Day period referred to in such Section, Project Co acknowledges and agrees that, after a further 10 Business Days, Project Co shall not be entitled to rely upon, and Contracting Authority shall not be obligated to consider, the Notice given under Section 32.2(a) for the purposes of determining Project Co’s entitlement to relief under this Section 32. Project Co, at its option, may submit a new, currently dated Notice which complies with the provisions of Section 32.2(a) for the same event or circumstance which gave rise to the previous, unsubstantiated Notice, and the provisions of this Section 32 shall apply to any new Notice, *mutatis mutandis*. Project Co acknowledges and agrees that Contracting Authority, in determining Project Co’s entitlement to an extension of time pursuant to this Section 32 and without limiting any other right of Contracting Authority under this Project Agreement, shall be entitled to take into account the delay between:
 - (i) Project Co becoming aware of the occurrence of the event or circumstance forming the basis of the original Notice delivered pursuant to Section 32.2(a); and
 - (ii) Project Co submitting any new Notice pursuant to Section 32.2(a) in respect of that event or occurrence.
- (m) If the Works are behind schedule for a reason other than a Delay Event, or if a Project Co Party delays the progress of any portion of the Works necessary to complete the Works on schedule,

Project Co shall use all reasonable measures to bring the Works back on schedule. Project Co shall exercise all means within its discretion, such as directing any Project Co Party that is creating delays to increase their labour forces and equipment, to improve the organization and expediting of the Works, or to work overtime as may be necessary. Project Co shall provide any additional supervision, coordination and expediting, including overtime by its own personnel as may be required to achieve this end. The costs and expenses incurred by the use of such measures and overtime shall be borne by Project Co and/or the Project Co Parties and there shall be no adjustment to the Guaranteed Price as a result of such costs and expenses and for clarity, no extension to the Scheduled Interim Completion Date or the Scheduled Substantial Completion Date.

- (n) Where there are concurrent delays, some of which are caused by Contracting Authority or others for whom Contracting Authority is responsible, and some of which are caused by Project Co or others for whom Project Co is responsible, Project Co shall not be entitled to either an extension in the Scheduled Interim Completion Date or the Substantial Completion Date or additional compensation to the extent of the concurrent delays. Concurrent delays are those that are caused by two or more independent events which affect the Scheduled Interim Completion Date or the Scheduled Substantial Completion Date where the time period over which such delays occur overlap in time, but only for the duration of the overlap.
- (o) Subject to Sections 11.19(b) and 11.9(c), Contracting Authority shall provide Project Co with access to and use of the Metrolinx Lands and the Existing Metrolinx Infrastructure as required pursuant to Section 16 of this Project Agreement in a manner consistent with the applicable Project Works Schedule(s) and in accordance with the notification requirements and restrictions set out in the Project Agreement, provided that Project Co agrees that the inability of Contracting Authority to provide Project Co with access to an area for construction activities not on the critical path for reasons set out in Sections 11.19(b) and 11.9(c) will not result in the occurrence of a Delay Event (and, for greater certainty, there shall not be a resulting change to the Scheduled Interim Completion Date or the Scheduled Substantial Completion Date) or a Compensation Event (and, for certainty, there shall not be any resulting change to the Guaranteed Price).
- (p) In no event shall the extension of time for a Delay Event be more than the necessary extension of the critical path as a result of the Delay Event.

32.3 Mitigation

- (a) If Project Co is (or claims to be) affected by a Delay Event, Project Co shall, and shall require all Project Co Parties to, take and continue to take commercially reasonable steps:
 - (i) to eliminate or mitigate the consequences of such event upon the performance of its obligations under this Project Agreement;
 - (ii) to continue to perform its obligations under this Project Agreement to the extent possible notwithstanding the Delay Event; and
 - (iii) to resume performance of its obligations under this Project Agreement affected by the Delay Event as soon as practicable.

- (b) To the extent that Project Co does not comply with its obligations under this Section 32.3, such failure shall be taken into account in determining Project Co's entitlement to an extension of time pursuant to this Section 32.

33. COMPENSATION EVENTS

33.1 Definition

- (a) For the purposes of this Project Agreement, "**Compensation Event**" means any event referred to in Sections 32.1(a)(ii), 32.1(a)(iii), 32.1(a)(iv) (subject to Section 32.2(o)), Section 32.1(a)(v), Section 32.1(a)(vi), Section 32.1(a)(vii), Section 32.1(a)(viii), Section 32.1(a)(ix), Section 32.1(a)(x), Section 32.1(a)(xi), Section 32.1(a)(xii), Section 32.1(a)(xiii), Section 32.1(a)(xviii), Section 32.1(a)(xix), Section 32.1(a)(xx) and Section 32.1(a)(xxi) as a direct result of which Project Co has incurred loss or expense, whether or not any of these events has also caused a delay.

33.2 Consequences of a Compensation Event

- (a) If a Compensation Event occurs, Project Co's sole right to compensation shall be as set out in this Section 33. For greater certainty, except as aforesaid, no other Delay Event shall entitle Project Co to receive any compensation, except as otherwise provided in:
- (i) Schedule 22 – Variation Procedure, in the case of a Delay Event referred to in Section 32.1(a)(i);
 - (ii) Section 35, in the case of a Delay Event referred to in Section 32.1(a)(xvi);
 - (iii) Section 34, in the case of a Delay Event referred to in Section 32.1(a)(xv);
 - (iv) Section 33.6(b), in the case of a Delay Event referred to in 32.1(a)(xiv); and
 - (v) Section 30, in the case of a Delay Event referred to in Section 32.1(a)(xvii).
- (b) Subject to Sections 33.2(c), 33.3, 33.4 and 33.5, if it is agreed, or determined in accordance with Schedule 27 – Dispute Resolution Procedure, that there has been a Compensation Event, Project Co shall be entitled to such compensation as would place Project Co in no better and no worse position than it would have been in had the relevant Compensation Event not occurred. For greater certainty, in respect of a Compensation Event that is also a Delay Event, such compensation will include amounts which, but for the Delay Event, would have been paid by Contracting Authority to Project Co. Project Co shall promptly provide the Contracting Authority Representative with any information the Contracting Authority Representative may require in order to determine the amount of such compensation.
- (c) If Contracting Authority is required to compensate Project Co pursuant to this Section 33.2, then Contracting Authority may either pay such compensation as a lump sum payment or payments at times and in a manner to be agreed with Project Co, acting reasonably.
- (d) To the extent that Project Co does not comply with its obligations under Sections 32.2(a), (b), (c), (d), (e), (f) or (g), and subject to Section 32.2(l), such failure shall be taken into account in determining Project Co's entitlement to relief pursuant to this Section 33.

- (e) If an event listed in Section 32.1(a) caused Project Co to be delayed as of the time of the applicable Scheduled Milestone Payment Completion Date, when delay is measured in accordance with Section 32.2, and such delay resulted in Project Co failing to achieve Milestone Payment Completion for either Milestone Payment, and to the extent that such failure was not caused, or contributed to, by Project Co or any Project Co Party,
- (i) in the case of the First Milestone Payment, Contracting Authority shall pay an amount equal to the increase in the Cost of the Financing in respect of the First Milestone Payment arising from the applicable period of delay, provided Project Co has complied with its obligations pursuant to Section 33.3;
 - (ii) in the case of the Second Milestone Payment, Contracting Authority shall pay an amount equal to the increase in the Cost of the Financing in respect of the Second Milestone Payment arising from the applicable period of delay, provided Project Co has complied with its obligations pursuant to Section 33.3 and without duplication of any amounts already paid by Contracting Authority in accordance with Section 33.2(e)(i);
 - (iii) all compensation owed to Project Co arising from Sections 33.2(e)(i) and 33.2(e)(ii) shall be calculated as of the Substantial Completion Date and shall be limited to only the compensation set out in Sections 33.2(e)(i) and 33.2(e)(ii); and
 - (iv) any amount payable by Contracting Authority pursuant to Section 33.2(e) shall be payable on the Substantial Completion Payment Date.

33.3 Mitigation

- (a) If Project Co is (or claims to be) affected by a Compensation Event, Project Co shall, and shall require all Project Co Parties to, take and continue to take commercially reasonable steps to minimize the amount of compensation due in accordance with this Section 33 in relation to any Compensation Event.
- (b) To the extent that Project Co does not comply with its obligations under this Section 33.3, such failure shall be taken into account in determining Project Co's entitlement to relief pursuant to this Section 33.

33.4 Insured Exposure

- (a) The compensation payable to Project Co pursuant to this Section 33 shall be reduced by any amount which Project Co or a Project Co Party recovers, or is entitled to recover, under any insurance policy, or would have recovered if it had complied with the requirements of this Project Agreement in respect of insurance or the terms of any policy of insurance required under this Project Agreement, which amount, for greater certainty, shall not include any excess or deductibles or any amount over the maximum amount insured under any such insurance policy.

33.5 Intentionally Deleted

33.6 Special Compensation Regarding Category 1 Utility Company.

- (a) For the purposes of the special compensation regarding Category 1 Utility Companies, the following shall apply:
- (i) Sections 33.3 and 33.4 shall apply to the compensation set out in this Section 33.6, notwithstanding that the Delay Event referred to in Section 32.1(a)(xiv) is not a Compensation Event.
 - (ii) For the purposes of Section 33.6(b)(i), “**Special Senior Debt Amount**” means the Senior Debt Service Amount accrued and paid or which became payable in accordance with the Lending Agreement specifically attributable to the Delay Event referred to in Section 32.1(a)(xiv), by Project Co or any Project Co Party, to the Senior Lenders up to and including the Scheduled Substantial Completion Date or the date of payment of the Contracting Authority Default Termination Sum or Non-Default Termination Sum, as applicable, together with interest thereon at the rate payable on the Senior Debt Amount, which, but for the Delay Event referred to in Section 32.1(a)(xiv) would not have been paid by Project Co to the Senior Lenders.
- (b) If it is agreed, or determined in accordance with Schedule 27 – Dispute Resolution Procedure, that there has been a Delay Event referred to in Section 32.1(a)(xiv), Project Co shall be entitled to the following:
- (i) an amount in respect of Senior Debt Service Amount calculated as follows:
 - (A) if the applicable Delay Event delays Substantial Completion for fewer than 30 days, Project Co shall not be entitled to any relief with respect to the Senior Debt Service Amount;
 - (B) if the applicable Delay Event delays Substantial Completion for 30 days to 180 days, Contracting Authority shall pay to Project Co an amount equal to 50 per cent of the Special Senior Debt Amount; and
 - (C) if the applicable Delay Event delays Substantial Completion for more than 180 days, Contracting Authority shall pay to Project Co an amount equal to,
 - (I) 50 per cent of the Special Senior Debt Amount in respect of the delay to Substantial Completion for 30 days to 180 days, plus,
 - (II) 100 per cent of the Special Senior Debt Amount in respect of the delay to Substantial Completion for the number of days exceeding 180 days; and
 - (ii) if the applicable Delay Event delays Substantial Completion for more than 180 days, an amount that would place Project Co in no better and no worse position than it would have been in had the applicable Delay Event lasted for 180 days, and excluding, for clarity, any amounts payable pursuant to Section 33.6(b)(i) or Section 4.21. For clarity, Project Co is

not entitled to any compensation in accordance with this Section 33.6(b)(i) for the first 180 days that the Delay Event delays Substantial Completion.

34. RELIEF EVENTS

34.1 Definition

(a) For the purposes of this Project Agreement, “**Relief Event**” means any of the following events or circumstances to the extent, in each case, that it causes any failure by a Party to perform any of its obligations under this Project Agreement:

- (i) fire, explosion, lightning, storm, tempest, hurricane, tornado, flood, bursting or overflowing of water tanks, apparatus or pipes, ionizing radiation (to the extent it does not constitute Force Majeure), earthquake, riot or civil commotion;
- (ii) failure by any Utility Company, local authority or other like body to perform works or provide services (solely in its role as utility service provider or similar service provider to the Project), provided, however, that such a failure shall not, in any event, be cause for a Relief Event, unless Project Co:
 - (A) has performed its obligations under any applicable agreement with the Utility Company with respect to the provision of such services and the relevant Utility Company has failed to meet its obligations thereunder; and
 - (B) has made all, and is continuing to make all, commercially reasonable efforts to diligently enforce its legal rights under any applicable agreement in respect of such services and otherwise cause the Utility Company to perform those works or services.

For clarity, Section 34.1(a)(ii) shall apply only in circumstances where the Utility Company is providing services to Project Co of the type provided by the Utility Company in the normal course of its business. For further clarity, Section 34.1(a)(ii) shall not apply in circumstances where Project Co has entered into an agreement for the design and construction of Utility Infrastructure and the applicable Utility Company has failed to comply with its obligations under such an agreement;

- (iii) accidental loss or damage to the Works and/or the New Metrolinx Infrastructure or any roads servicing the Lands;
- (iv) without prejudice to any obligation of Project Co to provide stand-by power facilities in accordance with this Project Agreement, failure or shortage of power, fuel or transport;
- (v) blockade or embargo falling short of Force Majeure;
- (vi) any official or unofficial strike, lockout, work to rule or other labour-related action generally affecting the New Metrolinx Infrastructure, the New Third Party Infrastructure or construction industry (or a significant sector of that industry) in the Province of Ontario;
or

- (vii) any civil disobedience or protest action, including any action taken by any person or persons protesting or demonstrating against the carrying out of any part of the Works or the construction and/or operation of transit systems in general, provided, however, that a civil disobedience or protest action shall not, in any event, be cause for a Relief Event unless Project Co has fully complied with Section 11.13,

provided, in each case, that such event does not arise (directly or indirectly) as a result of any act or omission of the Party claiming relief and/or (i) in the case of Project Co claiming relief, as a result of any act or omission of any Project Co Party and (ii) in the case of Contracting Authority claiming relief, as a result of any act or omission of any Contracting Authority Party.

34.2 Consequences of a Relief Event

- (a) Subject to Section 34.3, no right of termination, other than either Party's right to terminate this Project Agreement pursuant to Section 38.1, shall arise under this Project Agreement by reason of any failure by a Party to perform any of its obligations under this Project Agreement, but only to the extent that such failure to perform is caused by the occurrence of a Relief Event (it being acknowledged and agreed by the Parties that all other rights and obligations of the Parties under this Project Agreement remain unaffected by the occurrence of a Relief Event).
- (b) In respect of a Relief Event that is also a Delay Event pursuant to Section 32.1(a)(xv):
 - (i) Project Co shall only be relieved of its obligations under this Project Agreement to the extent, if any, provided for in Section 32; and
 - (ii) in respect of a Relief Event referred to in Sections 34.1(a)(ii) (but only in respect of failure by a Utility Company to perform works or provide services), 34.1(a)(v), 34.1(a)(vi) or 34.1(a)(vii), on the earlier of (A) the Substantial Completion Date and (B) the date of payment of the Contracting Authority Default Termination Sum or Non-Default Termination Sum (and as a part thereof) in accordance with Schedule 23 – Compensation on Termination, Contracting Authority shall pay to Project Co an amount equal to the Senior Debt Service Amount accrued and paid or that became payable in accordance with the Lending Agreements during the period of delay by Project Co or any Project Co Party to the Senior Lenders up to and including the Scheduled Substantial Completion Date or the date of payment of the Contracting Authority Default Termination Sum or Non-Default Termination Sum, as applicable, together with interest thereon at the rate payable on the Senior Debt Amount, which, but for the Delay Event, would not have been paid by Project Co to the Senior Lenders.
- (c) If a Relief Event occurs, Project Co shall not be entitled to receive any compensation other than as expressly provided in Sections 34.2(b)(ii) and 40.
- (d) Subject to Section 40, Project Co's sole right to payment or otherwise in relation to the occurrence of a Relief Event shall be as provided in this Section 34.

34.3 Mitigation and Process

- (a) Where a Party is (or claims to be) affected by a Relief Event, such Party shall take commercially reasonable steps to mitigate the consequences of the Relief Event upon the performance of its

obligations under this Project Agreement, shall resume performance of its obligations affected by the Relief Event as soon as practicable and shall use commercially reasonable efforts to remedy its failure to perform.

- (b) To the extent that the Party claiming relief does not comply with its obligations under this Section 34.3, such failure shall preclude such Party's entitlement to relief pursuant to this Section 34.
- (c) The Party claiming relief shall give written Notice to the other Party within five Business Days after such Party becoming aware of the relevant Relief Event. Such initial Notice shall give sufficient details to identify the particular event claimed to be a Relief Event.
- (d) A subsequent written Notice shall be given by the Party claiming relief to the other Party within a further five Business Days of the initial Notice, which Notice shall contain such relevant information relating to the failure to perform (or delay in performing) as is available, including the effect of the Relief Event on the ability of the Party to perform, the action being taken in accordance with Section 34.3(a), the date of the occurrence of the Relief Event, and an estimate of the period of time required to overcome the Relief Event and/or its effects.
- (e) The Party claiming relief shall notify the other as soon as the consequences of the Relief Event have ceased and of when performance of its affected obligations can be resumed.
- (f) If, following the issue of any Notice referred to in Section 34.3(d), the Party claiming relief receives or becomes aware of any further information relating to the Relief Event and/or any failure to perform, such Party shall submit such further information to the other Party as soon as reasonably possible.

34.4 Insured Exposure

- (a) The compensation payable to Project Co pursuant to this Section 34 shall be reduced by any amount which Project Co or a Project Co Party recovers, or is entitled to recover, under any insurance policy, or would have recovered if it had complied with the requirements of this Project Agreement in respect of insurance or the terms of any policy of insurance required under this Project Agreement, which amount, for greater certainty, shall not include any excess or deductibles or any amount over the maximum amount insured under any such insurance policy.

35. FORCE MAJEURE

35.1 Definition

- (a) For the purposes of this Project Agreement, "**Force Majeure**" means any of the following events or circumstances which directly causes either Party to be unable to perform all or a material part of its obligations under this Project Agreement:
 - (i) war, civil war, armed conflict, terrorism, acts of foreign enemies or hostilities;
 - (ii) nuclear or radioactive contamination of the Works, the New Metrolinx Infrastructure and/or the Lands, unless Project Co or any Project Co Party is the source or cause of the contamination;

- (iii) chemical or biological contamination of the Works, the New Metrolinx Infrastructure and/or the Lands from any event referred to in Section 35.1(a)(i);
- (iv) pressure waves caused by devices traveling at supersonic speeds; or
- (v) the discovery of any fossils, artifacts and other objects having artistic, historic, archaeological or monetary value, including human remains and burial sites, which, as a result of Applicable Law, requires the Works to be abandoned.

35.2 Consequences of Force Majeure

- (a) Subject to Section 35.3, the Party claiming relief shall be relieved from liability under this Project Agreement to the extent that, by reason of the Force Majeure, it is not able to perform its obligations under this Project Agreement.
- (b) In respect of an event of Force Majeure that is also a Delay Event pursuant to Section 32.1(a)(xvi):
 - (i) Project Co shall only be relieved of its obligations under this Project Agreement to the extent, if any, provided for in Section 32; and
 - (ii) on the earlier of (A) the Substantial Completion Date and (B) the date of payment of the Contracting Authority Default Termination Sum or Non-Default Termination Sum (and as a part thereof) in accordance with Schedule 23 – Compensation on Termination, Contracting Authority shall pay to Project Co an amount equal to the Senior Debt Service Amount and the Junior Debt Service Amount accrued and paid or that accrued in accordance with the Lending Agreements during the period of delay by Project Co or any Project Co Party to the Lenders up to and including the Scheduled Substantial Completion Date or the date of payment of the Contracting Authority Default Termination Sum or Non-Default Termination Sum, as applicable, together with interest thereon at the rate payable on the principal amount of debt funded under the Lending Agreements, which, but for the Delay Event, would not have been paid by Project Co to the Lenders.
- (c) If an event of Force Majeure occurs prior to the Substantial Completion Date, Project Co shall not be entitled to receive any compensation other than as expressly provided in Sections 35.2(b)(ii) and 40.
- (d) Subject to Section 40, Project Co's sole right to payment or otherwise in relation to the occurrence of an event of Force Majeure shall be as provided in this Section 35.

35.3 Mitigation and Process

- (a) Where a Party is (or claims to be) affected by an event of Force Majeure, such Party shall take commercially reasonable steps to mitigate the consequences of such event of Force Majeure upon the performance of its obligations under this Project Agreement, shall resume performance of its obligations affected by the event of Force Majeure as soon as practicable and shall use commercially reasonable efforts to remedy its failure to perform, including efforts to minimize any negative impact of the event of Force Majeure on the Project Works Schedules.

- (b) To the extent that the Party claiming relief does not comply with its obligations under this Section 35.3, such failure shall be taken into account in determining such Party's entitlement to relief pursuant to this Section 35.
- (c) The Party claiming relief shall give written Notice to the other Party within five Business Days after such Party becoming aware of the relevant event of Force Majeure. Such initial Notice shall give sufficient details to identify the particular event claimed to be an event of Force Majeure.
- (d) A subsequent written Notice shall be given by the Party claiming relief to the other Party within a further five Business Days of the initial Notice, which Notice shall contain such relevant information relating to the failure to perform (or delay in performing) as is available, including the effect of the event of Force Majeure on the ability of the Party to perform, the action being taken in accordance with Section 35.3(a), the date of the occurrence of the event of Force Majeure, and an estimate of the period of time required to overcome the event of Force Majeure and its effects.
- (e) The Party claiming relief shall notify the other as soon as the consequences of the event of Force Majeure have ceased and of when performance of its affected obligations can be resumed.
- (f) If, following the issue of any Notice referred to in Section 35.3(d), the Party claiming relief receives or becomes aware of any further information relating to the event of Force Majeure and/or any failure to perform, such Party shall submit such further information to the other Party as soon as reasonably possible.

35.4 Insured Exposure

- (a) The compensation payable to Project Co pursuant to this Section 35 shall be reduced by any amount which Project Co or a Project Co Party recovers, or is entitled to recover, under any insurance policy, or would have recovered if it had complied with the requirements of this Project Agreement in respect of insurance or the terms of any policy of insurance required under this Project Agreement, which amount, for greater certainty, shall not include any excess or deductibles or any amount over the maximum amount insured under any such insurance policy.

35.5 Modifications

- (a) The Parties shall use commercially reasonable efforts to agree to any modifications to this Project Agreement which may be equitable having regard to the nature of an event or events of Force Majeure. Schedule 27 – Dispute Resolution Procedure shall not apply to a failure of Contracting Authority and Project Co to reach agreement pursuant to this Section 35.5.

36. PROJECT CO DEFAULT

36.1 Project Co Events of Default

- (a) For the purposes of this Project Agreement, “**Project Co Event of Default**” means any one or more of the following events or circumstances:
 - (i) the occurrence of any of the following events other than as a consequence of a breach by Contracting Authority of its payment obligations hereunder:

- (A) Project Co admits in writing its inability to pay its debts generally as they become due, or makes a general assignment for the benefit of creditors, or a receiver, manager, administrator, administrative receiver, receiver and manager, trustee, custodian or other similar official or any other like person is appointed by or on behalf of or at the instance of a creditor of Project Co with respect to Project Co or any of the property, assets or undertaking of Project Co, or any creditor of Project Co takes control, or takes steps to take control, of Project Co or any of Project Co's assets, or any proceedings are instituted against Project Co that result in Project Co being declared or ordered bankrupt or in administration, liquidation, winding-up, reorganization, compromise, arrangement, adjustment, protection, relief or composition of it or with respect to it or its debts or obligations, or any such proceedings are instituted by Project Co seeking any such result, or any such proceedings are instituted by a person other than Project Co, Contracting Authority, a Contracting Authority Party or a person related to any of them seeking such result and such proceedings have or will have a material adverse effect on the performance of the Works or of the Contracting Authority Activities (where such proceedings have not been withdrawn, stayed, discharged, or are otherwise of no further effect, within 90 days after being instituted), under any Applicable Law (including the *Bankruptcy and Insolvency Act* (Canada) and the *Companies' Creditors Arrangement Act* (Canada)) relating to bankruptcy, insolvency or reorganization of or relief with respect to debtors or debtors' obligations or assets or other similar matters, or seeking the appointment of a receiver, manager, administrator, administrative receiver, receiver and manager, trustee, custodian or other similar official or like person for it or with respect to any of its assets, or any resolutions are passed or other corporate actions of Project Co are taken to authorize any of the actions set forth in this Section 36.1(a)(i);
- (B) Project Co ceases performing a substantial portion of its business, or a substantial portion of such business is suspended or is not being performed, whether voluntarily or involuntarily, that has or will have a material adverse effect on Project Co's ability to perform its obligations under this Project Agreement;
- (C) if any execution, sequestration, extent, garnishment or other process of or order by any court becomes enforceable against Project Co or if a distress or analogous process is levied against any property of Project Co that materially adversely affects Project Co's ability to perform its obligations hereunder; or
- (D) Project Co suffers any event, or any event or set of circumstances occurs or comes about, analogous to the foregoing events or sets of circumstances set out in this Section 36.1(a)(i) in any jurisdiction in which it is incorporated or resident and such event or set of circumstances would, if set out in Section 36.1(a)(i)(A), (B) or (C), constitute a Project Co Event of Default;
- (ii) Project Co failing to achieve Substantial Completion within 180 days after the Scheduled Substantial Completion Date (the "**Longstop Date**");
- (iii) Project Co either:

- (A) failing to deliver a Recovery Works Schedule under Section 14.1(b)(i) of Schedule 12 – Works Schedule Requirements;
 - (B) delivering a Recovery Works Schedule under Section under Section 14.1(b)(i) of Schedule 12 – Works Schedule Requirements which indicates that Project Co will not achieve Substantial Completion by the Longstop Date; or
 - (C) delivering a Recovery Works Schedule under Section 14.1(b)(i) of Schedule 12 – Works Schedule Requirements that is not acceptable to the Independent Certifier, acting reasonably, as to the matters set out in Section 14.1(c)(ii) of Schedule 12 – Works Schedule Requirements;
- (iv) Project Co making any representation or warranty herein that is false or misleading when made, and that has or will have at any time a material adverse effect on the performance of Works, the Governmental Activities, or that may compromise (A) Contracting Authority’s reputation or integrity, or (B) the nature of the public transit system in the Municipality or the Province of Ontario so as to affect public confidence in the public transit system in the Municipality, the Province of Ontario or the Project, and, in the case of a false or misleading representation or warranty that is capable of being remedied, such breach is not remedied within 10 Business Days after receipt of Notice of the same from Contracting Authority;
- (v) Project Co committing a breach of Sections 42 or 43;
- (vi) Project Co committing a breach of its obligations under this Project Agreement which has or will have a material adverse effect on the performance of Contracting Authority operations or Contracting Authority Activities (other than a breach that is otherwise referred to in Sections 36.1(a)(i) to (v) inclusive or (vii) to (xvi) inclusive) other than where such breach is a consequence of a breach by Contracting Authority of its obligations under this Project Agreement, and upon becoming aware of such breach Project Co failing to remedy such breach in accordance with all of the following:
- (A) Project Co shall:
 - (I) immediately commence and thereafter diligently continue to remedy the breach and to mitigate any adverse effects on Contracting Authority and the performance of Contracting Authority’s operations and the Contracting Authority Activities;
 - (II) put forward, within five Business Days after receipt of Notice of such breach from Contracting Authority, a reasonable plan and schedule for diligently remedying the breach and mitigating its effect, which plan and schedule shall specify in reasonable detail the manner in which, and the latest date by which, such breach is proposed to be remedied, which latest date shall in any event be within 60 days after Notice of such breach, or if such breach is not capable of being rectified in such period then such longer period as is reasonable in the circumstances; and

- (III) thereafter perform its obligations to achieve all elements of such plan and schedule in accordance with its terms within the time for the performance of its obligations thereunder;
- (vii) Project Co wholly abandoning the Works for a period which exceeds three Business Days from receipt by Project Co of a written request to return to the Site, other than as a consequence of a breach by Contracting Authority of its obligations under this Project Agreement;
- (viii) Project Co failing to comply with Sections 49.1 or 49.3;
- (ix) the occurrence of any Change in Ownership or Change in Control which is prohibited by Section 49.4;
- (x) Project Co failing to remove an Encumbrance that arose (i) due to an act or omission of Project Co or any Project Co Party (other than any Encumbrance derived through Contracting Authority), or (ii) in relation to the Works, in either case, within 45 days following the earlier of:
 - (A) the registration of such Encumbrance against title to the Lands or any part thereof; and
 - (B) the date on which Project Co or any Project Co Party knew, or ought to have known, about the existence of the Encumbrance;
- (xi) Project Co failing to pay any sum or sums due to Contracting Authority under this Project Agreement, which sum or sums are not being disputed in accordance with Schedule 27 – Dispute Resolution Procedure or have not been set off by Project Co pursuant to Section 4.11(a)(ii), and which sum or sums, either singly or in aggregate, exceed(s) \$[REDACTED] (index linked), and such failure continues for 30 days from receipt by Project Co of a Notice of non-payment from Contracting Authority;
- (xii) Project Co failing to comply with Section 50;
- (xiii) Project Co failing to comply with Section 8.3 or Schedule 28 – Refinancing;
- (xiv) Project Co failing to obtain any bond, security or insurance required to be obtained by or on behalf of Project Co pursuant to this Project Agreement or any such bond, security or insurance being vitiated or otherwise ceasing to be in full force and effect or in material compliance with the requirements set out in this Project Agreement, other than as a consequence of a breach by Contracting Authority of its obligations under this Project Agreement, and:
 - (A) in respect of insurance, such breach by Project Co is not remedied within 10 Business Days after the occurrence of the breach; and
 - (B) in respect of a bond or security, such breach by Project Co is not remedied within five Business Days after Project Co becoming aware of such breach;

- (xv) Project Co failing to comply with any determination, order or award made against Project Co in accordance with Schedule 27 – Dispute Resolution Procedure; or
- (xvi) A default by Project Co or any Project Co Party under any of the Ancillary Documents following the expiry of any applicable notice and cure periods thereunder.

36.2 Notification of Occurrence

- (a) Project Co shall, promptly upon Project Co becoming aware of the occurrence, notify Contracting Authority of the occurrence, and details, of any Project Co Event of Default and of any event or circumstance which is likely, with the passage of time, giving of Notice, determination of any condition, or otherwise, to constitute or give rise to a Project Co Event of Default.

36.3 Right to Termination

- (a) On the occurrence of a Project Co Event of Default, or at any time after Contracting Authority becomes aware of a Project Co Event of Default, and, if the occurrence of a Project Co Event of Default is disputed by Project Co in good faith, then following confirmation in accordance with Schedule 27 – Dispute Resolution Procedure that a Project Co Event of Default has occurred, Contracting Authority may, subject to Section 36.4, terminate this Project Agreement in its entirety by written Notice having immediate effect, such Notice to be given to Project Co, and to any person specified in the Lenders’ Direct Agreement to receive such Notice.

36.4 Remedy Provisions

- (a) In the case of a Project Co Event of Default referred to in Sections 36.1(a)(i)(B), 36.1(a)(i)(C), 36.1(a)(i)(D) (where the Project Co Event of Default referred to in Section 36.1(a)(i)(D) is analogous to a Project Co Event of Default referred to in Section 36.1(a)(i)(B) or 36.1(a)(i)(C)), 36.1(a)(iii), 36.1(a)(iv), 36.1(a)(v), 36.1(a)(vii), 36.1(a)(viii), 36.1(a)(ix), (where the Project Co Event of Default referred to in Section 36.1(a)(ix) is capable of being remedied), 36.1(a)(xi), 36.1(a)(xiii), 36.1(a)(xiv) (where the Project Co Event of Default referred to in Section 36.1(a)(xiv) is not in respect of insurance), 36.1(a)(xv), or 36.1(a)(xvi), Contracting Authority shall, prior to being entitled to terminate this Project Agreement, give Notice of default to Project Co, and to any person specified in the Lenders’ Direct Agreement to receive such Notice, and Project Co shall:
 - (i) within five Business Days after such Notice of default, put forward a reasonable plan and schedule for diligently remedying the Project Co Event of Default, which schedule shall specify in reasonable detail the manner in, and the latest date by which, such Project Co Event of Default is proposed to be remedied, which latest date shall, in any event, be within 30 days after the Notice of default, or if such breach is not capable of being remedied in such period then such longer period as is acceptable to Contracting Authority, acting reasonably; and
 - (ii) thereafter, perform its obligations to achieve all elements of such plan and schedule in accordance with its terms within the time for the performance of its obligations thereunder.

- (b) Where Project Co puts forward a plan and schedule in accordance with Section 36.4(a)(i) that has a date for the Project Co Event of Default to be remedied that is beyond 30 days from the Notice of default, Contracting Authority shall have five Business Days from receipt of the same within which to notify Project Co that Contracting Authority does not accept such longer period in the plan and schedule and that the 30 day limit will apply, failing which Contracting Authority shall be deemed to have accepted the longer period in the plan and schedule.
- (c) If a Project Co Event of Default, of which a Notice of default was given under Section 36.4(a), occurs and:
 - (i) Project Co fails to immediately commence and thereafter diligently continue to remedy the Project Co Event of Default and to mitigate any adverse effects on Contracting Authority and the Governmental Activities; or
 - (ii) Project Co fails to put forward a plan and schedule pursuant to Section 36.4(a)(i); or
 - (iii) such Project Co Event of Default is not remedied within 30 days after such Notice of default or such longer period as is established pursuant to the plan and schedule established pursuant to Sections 36.4(a) and (b); or
 - (iv) where Project Co puts forward a plan and schedule pursuant to Section 36.4(a)(i) and Project Co fails to perform its obligations thereunder necessary to achieve all elements of such plan and schedule in accordance with its terms within the time for the performance of its obligations,

then Contracting Authority may terminate this Project Agreement in its entirety by written Notice with immediate effect, such Notice to be given to Project Co, and to any person specified in the Lenders' Direct Agreement to receive such Notice.

- (d) Notwithstanding that Contracting Authority may give the Notice referred to in Section 36.4(a), and without prejudice to the other rights of Contracting Authority in this Section 36.4, at any time during which a Project Co Event of Default is continuing, Contracting Authority may, at Project Co's risk and expense, take such steps as Contracting Authority considers appropriate, either themselves or by engaging others (including a third party) to take such steps, to perform or obtain the performance of Project Co's obligations under this Project Agreement or to remedy such Project Co Event of Default.
- (e) Upon the occurrence of a Project Co Event of Default that Project Co has remedied pursuant to this Section 36.4, such occurrence of a Project Co Event of Default shall thereafter cease to be a Project Co Event of Default and Contracting Authority shall not be entitled to terminate this Project Agreement for that occurrence of a Project Co Event of Default.

36.5 Contracting Authority Costs

- (a) Project Co shall reimburse Contracting Authority for all reasonable costs (including all applicable Taxes and all legal or professional services, legal costs being on a full indemnity basis) properly incurred by Contracting Authority in exercising its rights under this Section 36, including any relevant increased administrative expenses. Contracting Authority shall take commercially reasonable steps to mitigate such costs.

36.6 No Other Rights to Terminate

- (a) Contracting Authority shall have no right or entitlement to terminate this Project Agreement, or to accept any repudiation of this Project Agreement, and shall not purport to exercise any such right or entitlement except as set forth in Sections 36 and 38.

37. CONTRACTING AUTHORITY DEFAULT

37.1 Contracting Authority Events of Default

- (a) For the purposes of this Project Agreement, “**Contracting Authority Event of Default**” means any one or more of the following events or circumstances:

- (i) Contracting Authority failing to pay any sum or sums due to Project Co under this Project Agreement, which sum or sums are not being disputed in accordance with Schedule 27 – Dispute Resolution Procedure or have not been set off by Contracting Authority pursuant to Section 4.11(a)(i), and which sum or sums, either singly or in aggregate, exceed(s) \$[REDACTED] (index linked), and:

(A) in respect of the Substantial Completion Payment or Legislative Holdback, such failure continues for a period of 10 Business Days; or

(B) in respect of any other payment due and payable by Contracting Authority to Project Co under this Project Agreement, such failure continues for a period of 90 days,

in any such case, from receipt by Contracting Authority of a Notice of non-payment from or on behalf of Project Co;

- (ii) Contracting Authority committing a material breach of its obligations under Section 16 (other than as a consequence of a breach by Project Co of its obligations under this Project Agreement), which breach materially adversely affects the ability of Project Co to perform its obligations under this Project Agreement for a continuous period of not less than 60 days; or

- (iii) an act of any Governmental Authority which renders it impossible for Project Co to perform all or substantially all of its remaining obligations under this Project Agreement (other than as a consequence of a breach by Project Co of its obligations under this Project Agreement) for a continuous period of not less than 60 days, provided that, for greater certainty, the non-issuance of, or the imposition of any conditions or limitations in, any of the Project Co Permits, Licences, Approvals and Agreements shall not constitute an “act of any Governmental Authority”.

37.2 Project Co’s Options

- (a) On the occurrence of a Contracting Authority Event of Default and while the same is continuing, Project Co may give Notice to Contracting Authority of the occurrence of such Contracting Authority Event of Default, which Notice will specify the details thereof, and, at Project Co’s

option and without prejudice to its other rights and remedies under this Project Agreement, Project Co may:

- (i) suspend performance of the Works until such time as Contracting Authority has remedied such Contracting Authority Event of Default; or
- (ii) if such Contracting Authority Event of Default has not been remedied within 30 days after receipt by Contracting Authority of Notice of the occurrence of such Contracting Authority Event of Default, terminate this Project Agreement in its entirety by Notice in writing having immediate effect.

37.3 Project Co's Costs

- (a) Contracting Authority shall reimburse Project Co for all reasonable costs (including all applicable Taxes and all legal or professional services, legal costs being on a full indemnity basis) properly incurred by Project Co in exercising its rights under this Section 37, including any relevant increased administrative expenses. Project Co shall take commercially reasonable steps to mitigate such costs.

37.4 No Other Rights to Terminate

- (a) Project Co shall have no right or entitlement to terminate this Project Agreement, nor to accept any repudiation of this Project Agreement, and shall not exercise, nor purport to exercise, any such right or entitlement except as expressly set forth in this Project Agreement.

38. RELIEF EVENT AND NON DEFAULT TERMINATION

38.1 Termination for Relief Event

- (a) If a Relief Event occurs and the effects of the Relief Event continue for 180 days from the date on which the Party affected gives Notice to the other Party pursuant to Section 34.3(c), either Party may, at any time thereafter, terminate this Project Agreement by written Notice to the other Party having immediate effect, provided that the effects of the Relief Event continue during such period to prevent either Party from performing a material part of its obligations under this Project Agreement.

38.2 Termination for Force Majeure

- (a) If an event of Force Majeure occurs and the Parties, having used commercially reasonable efforts, have failed to reach agreement on any modification to this Project Agreement pursuant to Section 35.5 within 180 days after the date on which the Party affected gives Notice to the other Party as set out therein, either Party may, at any time thereafter, terminate this Project Agreement by written Notice to the other Party having immediate effect, provided that the effects of the event of Force Majeure continue during such period to prevent either Party from performing a material part of its obligations under this Project Agreement.

38.3 Termination for Convenience

- (a) Contracting Authority shall, in its sole discretion and for any reason whatsoever, be entitled to terminate this Project Agreement at any time on 180 days' written Notice to Project Co.
- (b) In the event of Notice being given by Contracting Authority in accordance with this Section 38.3, Contracting Authority shall, at any time before the expiration of such Notice, be entitled to direct Project Co to refrain from commencing, or allowing any third party to commence, the Works, or any part or parts of the Works where such Works have not yet been commenced.

38.4 Automatic Expiry on Expiry Date

- (a) This Project Agreement shall terminate automatically on the Expiry Date.
- (b) Project Co shall not be entitled to any compensation due to termination of this Project Agreement on expiry of the Project Term on the Expiry Date.

39. EFFECT OF TERMINATION

39.1 Termination

- (a) Notwithstanding any provision of this Project Agreement, upon the service of a Notice of termination or termination on the Expiry Date pursuant to Section 38.4, this Section 39 shall apply in respect of such termination.

39.2 Continued Effect – No Waiver

- (a) Notwithstanding any breach of this Project Agreement by a Party, the other Party may elect to continue to treat this Project Agreement as being in full force and effect and to enforce its rights under this Project Agreement without prejudice to any other rights which such other Party may have in relation to such breach. The failure of either Party to exercise any right under this Project Agreement, including any right to terminate this Project Agreement and any right to claim damages, shall not be deemed to be a waiver of such right for any continuing or subsequent breach.

39.3 Continuing Performance

- (a) Subject to any exercise by Contracting Authority of its rights to perform, or to seek, pursuant to this Project Agreement, a third party to perform, the obligations of Project Co, the Parties shall continue to perform their obligations under this Project Agreement (including, if applicable, pursuant to Schedule 23 – Compensation on Termination) notwithstanding the giving of any Notice of default or Notice of termination, until the termination of this Project Agreement becomes effective in accordance with this Section 39.

39.4 Effect of Notice of Termination

- (a) On the service of a Notice of termination, or termination on the Expiry Date pursuant to Section 38.4:

- (i) if termination is prior to the Substantial Completion Date, in so far as any transfer shall be necessary to fully and effectively transfer such property to Contracting Authority as shall not already have been transferred to Contracting Authority pursuant to Section 45.1, Project Co shall transfer to, and there shall vest in, Contracting Authority, free from all Encumbrances (other than the Encumbrances caused or consented to by Contracting Authority), such part of the Works, the New Metrolinx Infrastructure, and the New Third Party Infrastructure as shall have been constructed and such items of the Plant, infrastructure and equipment as shall have been procured by Project Co, and, if Contracting Authority so elects:
 - (A) all Plant, equipment and materials (other than those referred to in Section 39.4(a)(i)(B)) on or near to the Lands shall remain available to Contracting Authority for the purposes of completing the Works; and
 - (B) all construction Plant and equipment shall remain available to Contracting Authority for the purposes of completing the Works, subject to payment by Contracting Authority of the Construction Contractor's reasonable charges;
- (ii) if termination is prior to the Substantial Completion Date, Project Co shall deliver to Contracting Authority (to the extent such items have not already been delivered to Contracting Authority) one complete set of all Project Data and Intellectual Property relating to the design, construction and completion of the Works, the New Metrolinx Infrastructure, and the New Third Party Infrastructure;
- (iii) in so far as title shall not have already passed to Contracting Authority pursuant to Section 45.1 or Section 39.4(a)(i), Project Co shall hand over to, and there shall vest in, Contracting Authority, free from all Encumbrances (other than any Encumbrances caused or consented to by Contracting Authority), the New Metrolinx Infrastructure and the New Third Party Infrastructure together with all other assets and rights capable of being transferred that are necessary for the performance of the Project and the Works and all facilities and equipment, and to the extent that any such assets or rights are not capable of being transferred by Project Co to Contracting Authority, Project Co shall enter into agreements or make other arrangements in order to permit the use of the assets or rights by Contracting Authority in order to enable them, or their designated agents or subcontractors, to continue to perform the activities which would have otherwise been performed by Project Co if this Project Agreement had not been terminated;
- (iv) if Contracting Authority so elects, Project Co shall ensure that any of the Subcontracts between Project Co and a Subcontractor (including the Design and Construction Contract), any other instrument entered into between any such Subcontractor and Project Co for securing the performance by such Subcontractor of its obligations in respect of the Works or to protect the interests of Project Co, shall be novated or assigned to Contracting Authority or its nominee, provided that where termination occurs other than as a result of a Project Co Event of Default, the consent of the relevant Subcontractor shall be required, and further provided that any such novation or assignment of the Design and Construction Contract with the Construction Contractor shall be made by Contracting Authority pursuant to, and subject to, the terms of the Construction Contractor's Direct Agreement;

- (v) Project Co shall, or shall ensure that any Project Co Party shall, offer to sell (and if Contracting Authority so elects, execute such sale) to Contracting Authority at a fair value (determined as between a willing vendor and willing purchaser, with any Disputes as to such fair value being resolved in accordance with Schedule 27 – Dispute Resolution Procedure), free from all Encumbrances (other than any Encumbrances caused or consented to by Contracting Authority), all or any part of the stocks of material and other assets, road vehicles, construction equipment, spare parts and other moveable property owned by Project Co or any Project Co Parties and dedicated to or predominantly used in respect of the New Metrolinx Infrastructure, and reasonably required by Contracting Authority in connection with the operation of the New Metrolinx Infrastructure;
- (vi) Project Co shall use commercially reasonable efforts to assign, or otherwise transfer, to Contracting Authority, free from all Encumbrances (other than any Encumbrances caused or consented to by Contracting Authority), the benefit of all manufacturers' warranties, including all documentation in respect thereof, in respect of mechanical and electrical Plant and equipment used or made available by Project Co under this Project Agreement and included in the New Metrolinx Infrastructure and the New Third Party Infrastructure; and
- (vii) Project Co shall deliver to Contracting Authority all information, reports, documents, records and the like referred to in Section 28, including as referred to in Schedule 26 – Record Provisions, except where such are required by Applicable Law to be retained by Project Co or the Project Co Parties (in which case complete copies shall be delivered to Contracting Authority).

39.5 Ownership of Information

- (a) Subject to Section 41, all information obtained by Project Co, including the As Built Drawings, Record Drawings, and other technical drawings and data, supplier agreements and contracts, utilities consumption information, environmental and technical reports, static building information, lease, licence and subletting data and contracts, asset condition data, standard operating procedures, processes and manuals and all other information directly related to the Works accumulated over the course of the Project Term shall be the property of Contracting Authority and upon termination of this Project Agreement shall be provided or returned to Contracting Authority, as applicable, in electronic format acceptable to Contracting Authority, acting reasonably, where it exists in electronic format, and in its original format, when not in electronic format.

39.6 Provision in Subcontracts

- (a) Project Co shall make provision in all Subcontracts to which it is a party (including requiring the relevant Project Co Parties to make such provision and to require other Project Co Parties to make such provision) to ensure that Contracting Authority shall be in a position to exercise its rights, and Project Co shall be in a position to perform its obligations, under this Section 39.

39.7 Transitional Arrangements

- (a) On the termination of this Project Agreement for any reason, for a reasonable period both before and after any such termination, Project Co shall:

- (i) as soon as practicable remove from the Lands all property belonging to Project Co or any Project Co Party that is not acquired by Contracting Authority pursuant to Section 39.4 or otherwise, and, if Project Co has not done so within 60 days after any Notice from Contracting Authority requiring it to do so, Contracting Authority may, without being responsible for any loss, damage, costs or expenses, remove and sell any such property and shall hold any proceeds, less all costs incurred to the credit of Project Co;
- (ii) forthwith deliver to the Contracting Authority Representative:
 - (A) all keys to, and any pass cards and other devices used to gain access to any part of the New Metrolinx Infrastructure; and
 - (B) to the extent transferable and without prejudice to Contracting Authority's rights pursuant to Section 41, any copyright licences for any computer programs, or licences to use the same, used in connection with the operation of the New Metrolinx Infrastructure; and
- (iii) as soon as practicable vacate the Lands and shall leave the Lands and the New Metrolinx Infrastructure in a safe, clean and orderly condition.

39.8 Termination upon Aforesaid Transfer

- (a) On completion of Project Co's obligations pursuant to this Section 39, this Project Agreement shall terminate and, except as provided in Section 39.9, all rights and obligations of Contracting Authority and Project Co under this Project Agreement shall cease and be of no further force and effect.

39.9 Survival

- (a) Except as otherwise provided in this Project Agreement, termination of this Project Agreement shall be without prejudice to, and shall not affect:
 - (i) all representations, warranties and indemnities under this Project Agreement; and
 - (ii) Sections 1.2, 1.3, 4.11, 4.12, 4.14, 6, 7, 8, 11.16, 11.17, 11.18, 17.2, 18.1, 18.2(a), 18.3(a), 18.4(a), 22.6, 24.12, 25.14, 27, 28, 36.5, 37.3, 38.4, 39, 40, 41 (with the exception of 41.4(b)), 42, 43, 44.3, 45, 46, 47, 48, 50.3, 51.1, 54.4, 54.8, 54.9, 54.10, 54.11, 54.12 of this Project Agreement, Schedule 7B – Warranty Letter of Credit, Schedule 14 – Outline Commissioning Program and Handover, Schedule 23 – Compensation on Termination, Schedule 32 – Financial Model, Sections 1.2-1.8 of Schedule 26 – Record Provisions, Schedule 27 – Dispute Resolution Procedure, Sections 2.1-2.6 and 3.2-3.9 of Schedule 24 – Intellectual Property, and any other provisions of this Project Agreement which are expressed to survive termination or which are required to give effect to such provisions which survive termination or to such termination or the consequences of such termination,

all of which shall survive the termination of this Project Agreement, including for termination on the Expiry Date pursuant to Section 38.4. For clarity, any termination of this Project Agreement shall be without prejudice to, and shall not affect, the Performance Guarantee of Construction Guarantor, which shall survive the termination of this Project Agreement, including termination

on the Expiry Date pursuant to Section 38.4, in respect of any and all of such surviving provisions of the Project Agreement.

40. COMPENSATION ON TERMINATION

40.1 Compensation on Termination

- (a) If this Project Agreement is terminated in accordance with the terms hereof, then Schedule 23 – Compensation on Termination shall apply and Contracting Authority shall pay Project Co any applicable compensation on termination.

40.2 Full and Final Settlement

- (a) Except as otherwise provided in Section 40.2(b), any compensation paid pursuant to this Section 40, including pursuant to Schedule 23 – Compensation on Termination in the total amount owing thereunder, shall be in full and final settlement of any claims, demands and proceedings of Project Co and Contracting Authority, and each shall be released from all liability to the other in relation to any breaches or other events leading to such termination of this Project Agreement, and the circumstances leading to such breach or termination, and Project Co and Contracting Authority shall be precluded from exercising all other rights and remedies in respect of any such breach or termination whether in contract, tort, restitution, statute, at common law or otherwise.
- (b) Section 40.2(a) shall be without prejudice to:
- (i) any liability of either Party to the other, including under the indemnities contained in this Project Agreement, that arose prior to the Termination Date (but not from the termination itself or the events leading to such termination) to the extent such liability has not already been set off pursuant to Section 4.11 or taken into account pursuant to Schedule 23 – Compensation on Termination in determining or agreeing upon the Contracting Authority Default Termination Sum, Non-Default Termination Sum, Project Co Default Termination Sum or any other termination sum, as the case may be; and
 - (ii) any liabilities arising under or in respect of any breach by either Party of their obligations under Section 39.9 of this Project Agreement, or the Sections referred to therein, which did not lead to such termination and which arises or continues after the Termination Date.

41. INTELLECTUAL PROPERTY

41.1 Ownership of Intellectual Property

- (a) Subject to Section 41.3(a), the Ownership of Intellectual Property shall be as set out in Schedule 24 – Intellectual Property. Project Co and Contracting Authority shall each comply with the requirements of Schedule 24 – Intellectual Property.

41.2 Licenses to Intellectual Property

- (a) Schedule 24 – Intellectual Property sets out the terms on which Intellectual Property used or supplied in connection with the Project will be licenced.

41.3 Representation and Warranty

- (a) Project Co represents, warrants and covenants to Contracting Authority that:
- (i) Project Co has and shall have the full and unencumbered right to provide all rights and licenses granted to Contracting Authority in this Project Agreement and to make all assignments of Intellectual Property as contemplated in this Project Agreement and to otherwise fully comply with the terms and requirements of Schedule 24 – Intellectual Property and its obligations therein;
 - (ii) any Intellectual Property licenses to Contracting Authority pursuant to this Project Agreement does not and shall not infringe, and is not and shall not be misappropriation of, any third party Intellectual Property rights;
 - (iii) as of Commercial Close:
 - (A) Project Co has not received any alleged infringement or misappropriation notices from third parties regarding any such Intellectual Property; and
 - (B) no fact is known to Project Co (including in respect of any actual, pending or threatened disputes, claims, suits, actions or proceedings or any other circumstance or event) that will, or could reasonably, effect, limit or prevent Project Co from fully complying with this Section 41.3(a).

41.4 Jointly Developed Materials

- (a) To the extent any data, documents, drawings, reports, plans, software, formulae, calculations or designs or any other materials or Intellectual Property are developed jointly by,
- (i) Project Co or any Subcontractor and Contracting Authority to the exclusion of any other party pursuant to this Project Agreement or in relation to the New Metrolinx Infrastructure, the Metrolinx Lands or Works (the “**Contracting Authority Jointly Developed Materials**”); and
 - (ii) Project Co or any Subcontractor and the Municipality to the exclusion of any other party in relation to the New Third Party Infrastructure that will be owned by the applicable third party owner (the “**Municipal Jointly Developed Materials**”),
- (together, the “**Jointly Developed Materials**”), then the Parties hereby acknowledge and agree that,
- (iii) Contracting Authority shall be the sole and exclusive owner of all right, title and interest in and to the Contracting Authority Jointly Developed Materials, any Intellectual Property associated therewith and any and all Modifications thereto and Project Co shall, at the request of Contracting Authority, execute such further agreements and cause the Subcontractors to execute any and all assignments, waivers of moral rights and other documents as may be reasonably required to fulfill the intent of this provision; and

- (iv) the Municipality shall be the sole and exclusive owner of all right, title and interest in and to the Municipal Jointly Developed Materials, any Intellectual Property associated therewith and any and all Modifications thereto and that Project Co shall, at the request of the Municipality, execute such further agreements and cause the Subcontractors to execute any and all assignments, waivers of moral rights and other documents as may be reasonably required to fulfill the intent of this provision.
- (b) Contracting Authority hereby grants Project Co a royalty free, non-exclusive and non-transferable licence, with a right to grant sub-licences to each Subcontractor, to use the Contracting Authority Jointly Developed Materials during the Project Term for the sole purposes of Project Co or any Subcontractor performing its obligations under this Project Agreement or its Subcontract, as applicable. For clarity, the licence granted to Project Co in accordance with this Section 41.4(b) shall not extend to any Municipal Jointly Developed Materials.
- (c) Upon termination of this Project Agreement, all rights and licences whatsoever granted to Project Co in the Jointly Developed Materials shall automatically terminate, and Project Co shall return any and all Jointly Developed Materials in the custody or possession of Project Co to,
 - (i) Contracting Authority, in the case of the Contracting Authority Jointly Developed Materials; and
 - (ii) the Municipality, in the case of the Municipal Jointly Developed Materials.
- (d) In the event of any inconsistency between this Section 41.4 and any provision of Schedule 24 – Intellectual Property, the wording of this Section 41.4 shall prevail.

41.5 Maintenance of Data

- (a) To the extent that any of the data, materials and documents referred to in this Section 41 or Schedule 24 – Intellectual Property are generated by, or maintained on, a computer or similar system, Project Co shall procure for the benefit of Contracting Authority, either at no charge or at the lowest reasonable fee, the grant of a licence or sub-licence for any relevant software to enable Contracting Authority or its nominee to access and otherwise Use (subject to the payment by Contracting Authority of any relevant fee) such data, materials and documents in accordance with rights granted pursuant to Schedule 24 – Intellectual Property.
- (b) For the purposes of Section 41.5(a), “Use” has the meaning set out in Schedule 24 – Intellectual Property, and includes the Limited Modification Rights.
- (c) Without limiting the obligations of Project Co under Section 41.5(a), Project Co shall ensure the back-up and storage in safe custody of the data, materials and documents referred to in this Section 41 in accordance with Good Industry Practice. Project Co shall submit to the Contracting Authority Representative Project Co’s proposals for the back-up and storage in safe custody of such data, materials and documents and Contracting Authority shall be entitled to object if the same is not in accordance with Good Industry Practice. Project Co shall comply, and shall cause all Project Co Parties to comply, with all procedures to which the Contracting Authority Representative has not objected. Project Co may vary its procedures for such back-up and storage subject to submitting its proposals for change to the Contracting Authority Representative, who shall be entitled to object on the basis set out above. Any Disputes in connection with the

provisions of this Section 41.5(c) may be referred for resolution in accordance with Schedule 27 – Dispute Resolution Procedure with reference to Good Industry Practice.

41.6 Contracting Authority Trade-Marks

- (a) Project Co shall not:
- (i) use any Contracting Authority Trade-Marks without obtaining a trade-mark licence on terms and conditions mutually satisfactory to Contracting Authority and Project Co, each acting reasonably; or
 - (ii) use the names or any identifying logos or otherwise of Contracting Authority or the Contracting Authority Representative in any advertising or permit them so to be used except with the prior written consent of Contracting Authority.

41.7 Confidential Information

- (a) It is expressly acknowledged and agreed that nothing in this Section 41 shall be deemed to create or convey to a Party any right, title, or interest in and/or to the Confidential Information of the other Party.

41.8 Government Use of Documents

- (a) Project Co hereby disclaims any right, title or interest of any nature whatsoever it may have in or to this Project Agreement that might prohibit or otherwise interfere with Contracting Authority's ability to use this Project Agreement in any manner desired by Contracting Authority.
- (b) Project Co hereby consents to the use by Contracting Authority of this Project Agreement, and any portion thereof, subject to compliance with FIPPA and to the removal by Contracting Authority (in consultation with Project Co) of any information supplied in confidence to Contracting Authority by Project Co in circumstances where disclosure may be refused under section 17(1) of FIPPA.

41.9 Restrictions

- (a) The Parties hereby agree that either Party may use the Project Know-How for any purpose, provided, however, that neither Project Co nor any Subcontractor shall use the Project Know-How to the extent that such Project Know-How incorporates, references or is otherwise based on the Project Data, the Intellectual Property Rights, the Jointly Developed Materials, the Intellectual Property of Contracting Authority, the Intellectual Property of any Contracting Authority Party or any third party provided by Contracting Authority, the Confidential Information of Contracting Authority, or the Confidential Information of any Contracting Authority Party or any third party provided by Contracting Authority, including the Output Specifications unless such use is otherwise permitted pursuant to this Project Agreement in order to enable Project Co and the Project Co Parties to meet Project Co's obligations under this Project Agreement.
- (b) Project Co hereby covenants and agrees that it will not make any commercial use, including use in any other request for proposal or similar procurement process, of the Project Data, the Intellectual Property Rights, the Jointly Developed Materials, the Intellectual Property of

Contracting Authority, the Intellectual Property of any Contracting Authority Party or any third party provided by Contracting Authority, the Confidential Information of Contracting Authority, or the Confidential Information of any Contracting Authority Party or any third party provided by Contracting Authority, including the Output Specifications, or any other drawings, reports, documents, plans, formulae, calculations, manuals, or other data that was created specifically for the Project or was based upon the Project Data, the Intellectual Property Rights, the Jointly Developed Materials, the Intellectual Property of Contracting Authority, the Intellectual Property of any Contracting Authority Party provided by Contracting Authority, the Confidential Information of Contracting Authority, or the Confidential Information of any Contracting Authority Party provided by Contracting Authority, including the Output Specifications.

- (c) Nothing in this Section 41.9 shall be deemed to grant to any party (including any Subcontractor or any personnel thereof) any right or license in respect of any other party's or other persons' Intellectual Property.

42. CONFIDENTIALITY

42.1 Disclosure

- (a) Subject to Sections 42.1(b), 42.1(c) and 42.2, but notwithstanding anything else in this Project Agreement to the contrary, Project Co acknowledges and agrees that Contracting Authority has a right to disclose or publish (including on websites) this Project Agreement, any or all terms hereof, including any or all contractual submissions and other records kept in accordance with this Project Agreement, any information related to the performance of Project Co (or any Project Co Party) or any information derived from this Project Agreement or the information related to the performance of Project Co (or any Project Co Party) as each of IO and Metrolinx, in their sole discretion, may consider appropriate. In exercising their discretion, each of IO and Metrolinx will be guided by the principles set out in Sections 42.1(b) and 42.1(c).
- (b) Contracting Authority will not disclose portions of this Project Agreement, any terms hereof, including any contractual submissions or other records kept in accordance with this Project Agreement, any information related to the performance of Project Co (or any Project Co Party) or any information derived from this Project Agreement or the information related to the performance of Project Co (or any Project Co Party) which would be exempt from disclosure under section 17(1) of FIPPA.
- (c) Notwithstanding Section 42.1(b), but subject to Section 42.2, where a compelling public interest in the disclosure of the information clearly outweighs the public interest in limiting the disclosure of the information supplied by Project Co (or any Project Co Party), Contracting Authority may disclose such information.
- (d) Notwithstanding anything else in this Project Agreement to the contrary, Project Co acknowledges and agrees that this Project Agreement and any or all terms thereof are subject to the Open Data Directive and that the Ontario ministries and agencies are required to disclose or publish certain data in accordance with the Open Data Directive.

42.2 Redaction

- (a) Prior to disclosing or publishing this Project Agreement, any terms hereof, including any contractual submissions or other records kept in accordance with this Project Agreement, any information related to the performance of Project Co (or any Project Co Party) or any information derived from this Project Agreement or the information related to the performance of Project Co (or any Project Co Party), Contracting Authority shall provide to Project Co a redacted version of this Project Agreement or other documents or information to be disclosed or published, on the basis that the information so redacted constitutes information which should not be disclosed pursuant to Section 42.1(b). The Parties acknowledge and agree that the Guaranteed Price, but not any breakdown thereof, may be disclosed.
- (b) If Project Co, acting in good faith, contends that any of the information not redacted constitutes information that falls within the scope of Section 42.1(b) and, accordingly, would be exempt from disclosure under FIPPA, the dispute may be referred for resolution in accordance with Schedule 27 – Dispute Resolution Procedure, and Contracting Authority shall not disclose any information in dispute until a determination is made. Any such determination shall be made with reference to the text and principles of FIPPA.

42.3 Disclosure to Government

- (a) Project Co acknowledges and agrees that subject to compliance with FIPPA, Contracting Authority will be free to use, disclose or publish (including on websites) any information, including Confidential Information, on such terms and in such manner as Contracting Authority see fit.
- (b) For greater certainty, Project Co acknowledges and agrees that, subject only to the removal of any information which Project Co is (or would be) entitled to refuse to disclose pursuant to section 17(1) of FIPPA, this Project Agreement, any contractual submissions or other records kept in accordance with this Project Agreement, any information related to the performance of Project Co (or any Project Co Party) or any information derived from this Project Agreement or the information related to the performance of Project Co (or any Project Co Party) are public documents and information and, as such, may be disclosed by Contracting Authority.

42.4 Freedom of Information and Protection of Privacy Acts

- (a) The Parties acknowledge and agree that,
 - (i) FIPPA applies to Contracting Authority, and that Contracting Authority is required to fully comply with FIPPA; and
 - (ii) MFIPPA may apply to the owners of any New Third Party Infrastructure, and that such owners of any New Third Party Infrastructure are required to fully comply with MFIPPA.
- (b) Contracting Authority shall, within the time periods provided in FIPPA for a party to exercise rights to prevent disclosure of information, advise Project Co of any request for Confidential Information that relates to Project Co (or any Project Co Party) or of Contracting Authority's intention to voluntarily release any information or documents which contain Confidential Information that relates to Project Co (or any Project Co Party).

42.5 Use and Disclosure of Confidential Information

- (a) Except as authorized hereunder, each Party shall hold in confidence, not disclose and not permit any person any manner of access to, whether directly or indirectly, any Confidential Information of the other Party, provided that this Section 42 shall not restrict either Party from disclosing such Confidential Information to its professional advisors, to the extent necessary, to enable that Party to perform, to cause to be performed, or to enforce, its rights or obligations under this Project Agreement.
- (b) Project Co may:
 - (i) disclose in confidence to the Lenders and prospective Lenders, including any trustee or agent of the Lenders and the Lenders' Agent, and their respective professional advisors such Confidential Information as is reasonably required by the Lenders in connection with the raising or syndication of the financing or any sub-participation in the financing of the Works or which Project Co is obliged to supply by the terms of the Lending Agreements; and
 - (ii) disclose in confidence to any Project Co Party and their professional advisors, such Confidential Information as is necessary for the performance by that Project Co Party of that Project Co Party's obligations under this Project Agreement.
- (c) Project Co acknowledges that Contracting Authority may use the Confidential Information of Project Co for purposes not specific to the Project, but for other general governmental purposes, such as development of the Province's alternate procurement and financing policies and framework. Contracting Authority will advise Project Co prior to using any Confidential Information of Project Co for non-Project purposes.
- (d) Subject to the foregoing, neither Party shall use, or directly or indirectly cause, authorize or permit any other person to use, any Confidential Information of the other Party except for the purposes of this Project Agreement, as permitted by this Project Agreement or as authorized by the disclosing Party in writing.
- (e) Each Party shall,
 - (i) protect all Confidential Information of the disclosing Party with the same degree of care as it uses to prevent the unauthorized use, disclosure, publication, or dissemination of its own confidential information of a similar nature or character, but in no event with less than a reasonable degree of care;
 - (ii) if legally compelled to disclose any Confidential Information,
 - (A) provide the disclosing Party with prompt Notice to that effect to allow the disclosing Party to seek any appropriate remedies and cooperate with the disclosing Party and its legal counsel; and
 - (B) disclose only that portion of the Confidential Information that it is legally required to disclose; and

- (iii) provide Confidential Information to the disclosing Party upon demand by the disclosing Party.

Section 42.5(e)(iii) shall not apply to Confidential Information in relation to which a Party has been provided a licence pursuant to Schedule 24 – Intellectual Property provided that the use of such Confidential Information is in accordance with Schedule 24 – Intellectual Property.

- (f) Without limiting the generality of this Section 42.5, Project Co shall comply with the document control and security protocol submitted by Project Co pursuant to Section 11.5 and approved by Contracting Authority, which protocol shall prescribe limitations on the use, disclosure and storage of this Project Agreement and any other Confidential Information specified by Contracting Authority.

42.6 Exceptions

- (a) Information of a Party (the “**Proprietor**”), other than Government Sensitive Information and other than Personal Information, will not be considered to be Confidential Information in the following circumstances:
 - (i) the Proprietor advises the other Party to whom the information has been disclosed (the “**Confidant**”) that the information is not required to be treated as Confidential Information;
 - (ii) the information is as of the date of this Project Agreement, or becomes at any time thereafter, generally available to or accessible by the public through no fault or wrongdoing of the Confidant;
 - (iii) the information is a matter of public record or in the public domain;
 - (iv) the information was in the possession of the Confidant prior to its disclosure and the Confidant came into possession of such information without being in breach of this Project Agreement;
 - (v) the information is received by the Confidant on a non-confidential basis from a source other than the Proprietor, provided that to the best of the Confidant’s knowledge such source is not bound by a confidentiality agreement with the Proprietor or otherwise prohibited from disclosing the information to the Confidant by a contractual, legal or fiduciary obligation;
 - (vi) the information was independently developed by the Confidant without access to the Confidential Information, as evidenced by written records;
 - (vii) the information is required to be disclosed pursuant to Applicable Law, provided that the Confidant provides the Proprietor with reasonable notification and an opportunity to contest such requirement prior to disclosure;
 - (viii) the information is disclosed to Contracting Authority upon a termination of this Project Agreement, pursuant to Section 38 or is otherwise required by Contracting Authority for

the purposes of performing (or having performed) the Works, including the design or construction of the New Metrolinx Infrastructure, or any other operations or services the same as, or similar to, the Works; or

- (ix) the information would not be exempt from disclosure under FIPPA.

42.7 Survival of Confidentiality

- (a) The obligations in Section 42.1 to Section 42.6 will cease on the date that is three years after the Termination Date and accordingly shall survive the termination of the Project Agreement.

42.8 Confidentiality of Intellectual Property

- (a) Nothing in this Section 42 shall prevent Contracting Authority from exercising any right granted to Contracting Authority pursuant to Schedule 24 – Intellectual Property. Contracting Authority shall have the right to disclose Confidential Information of Project Co Parties when exercising the rights granted pursuant to Schedule 24 – Intellectual Property in accordance therewith.

43. PERSONAL INFORMATION

43.1 General

- (a) Project Co acknowledges the importance of maintaining the confidentiality and privacy of Personal Information.
- (b) Project Co shall, and shall require each Project Co Party to, only collect, hold, process, use, store and disclose Personal Information with the prior consent of Contracting Authority and: (i) shall not collect, hold, process, use or store Personal Information except to the extent necessary to perform Project Co's obligations under this Project Agreement; and (ii) shall not disclose Personal Information or otherwise permit access to or make Personal Information available to any person except as expressly permitted or instructed by Contracting Authority.
- (c) Project Co shall, and shall require each Project Co Party to, at all times treat Personal Information as strictly confidential and shall comply with all applicable requirements of the Output Specifications and the requirements of Applicable Law, including *FIPPA*, the *Personal Information Protection and Electronic Documents Act* (Canada), and any other Canadian federal or provincial legislation now in force or that may in the future come into force governing the collection, use, disclosure and protection of personal information applicable to Project Co, each Project Co Party or to the Works.
- (d) Project Co shall take all necessary and appropriate action, and shall require each Project Co Party to take all necessary and appropriate action, against any person who fails to comply with this Section 43.1.
- (e) Project Co shall allow Contracting Authority on reasonable Notice to inspect any Personal Information in the custody or possession of Project Co or a Project Co Party and to audit Project Co and each Project Co Party's compliance with this Section 43 including the measures used by Project Co and each Project Co Party to protect Personal Information, and otherwise promptly and

properly respond to all reasonable inquiries of Contracting Authority with respect to Project Co or each Project Co Party's handling of Personal Information.

- (f) Project Co shall not subcontract or delegate to any third party any of the Works that involve or may involve the collection, use, storage, processing or any other handling of Personal Information without the express consent of Contracting Authority and without obtaining written contractual commitments of such third party substantially the same as those of this Section 43.

43.2 Protection of Personal Information

- (a) Project Co shall implement and use, and shall require each Project Co Party to implement and use, appropriate technical, organizational and physical security measures to protect Personal Information against loss, theft and unauthorized access, disclosure, copying, use, modification or disposal, and shall otherwise ensure that Project Co, the Project Co Parties, and its and their staff shall protect, secure and keep confidential any Personal Information.
- (b) Project Co shall and shall cause each Project Co Party to restrict access to Personal Information to only those authorized employees and permitted Project Co Parties that require access to such Personal Information to fulfil their job requirements in connection with the Works and that are subject to obligations of confidentiality and Personal Information protection no less stringent than those of this Section 43.
- (c) Upon termination of this Project Agreement or upon request of Contracting Authority, whichever comes first, Project Co shall immediately cease all use of and return to Contracting Authority or, at the direction of Contracting Authority, dispose of, destroy or render permanently anonymous all Personal Information, in each case using appropriate technical, organizational and physical security measures to protect Personal Information against loss, theft and unauthorized access, disclosure, copying, use or modification.
- (d) To the extent that any of the Works involve or may involve destruction or disposal of Personal Information, including any disposal or destruction pursuant to Section 43.2(c), such activities shall include, at a minimum, irreversible destruction, shredding or pulverizing of all documents, records or media containing Personal Information to a size or state that ensures that the document, record or other medium is permanently destroyed and that no information contained therein can be read, reconstructed or deciphered.
- (e) Project Co shall immediately inform Contracting Authority of any actual or suspected loss, theft or accidental or unauthorized access, disclosure, copying, use, modification or destruction of Personal Information by Project Co or any Project Co Party or any other breach of this Section 43.
- (f) Contracting Authority may from time to time require that Project Co and any Project Co Party or member of its or their staff execute and deliver within two Business Days after such request an agreement satisfactory to Contracting Authority, acting reasonably, requiring such person to keep Personal Information confidential.

43.3 Personal Information

- (a) Project Co shall provide, and shall cause each Project Co Party to provide, in a timely manner, all necessary and reasonable information and co-operation to Contracting Authority and to any

regulatory or other governmental bodies or authorities with jurisdiction or oversight over Applicable Law governing the collection, use, disclosure and protection of personal information in connection with any investigations, audits or inquiries made by any such bodies or authorities under such legislation.

- (b) To the extent of any conflict or inconsistency between this Section 43 and any other provision of the Project Agreement, this Section 43 shall prevail.
- (c) The obligations in this Section 43.3 shall survive the termination of this Project Agreement.

44. INSURANCE AND PERFORMANCE SECURITY

44.1 General Requirements

- (a) Project Co and Contracting Authority shall comply with the provisions of Schedule 25 – Insurance and Performance Security Requirements.

44.2 No Relief from Liabilities and Obligations

- (a) Neither compliance nor failure to comply with the insurance provisions of this Project Agreement shall relieve Project Co or Contracting Authority of their respective liabilities and obligations under this Project Agreement.

44.3 Performance Guarantee of Construction Guarantor

- (a) At all times during the Project Term and, in respect of the provisions described in Section 39.9, following the Project Term, Project Co shall ensure that a valid and binding Performance Guarantee of Construction Guarantor in favour of Contracting Authority from the Construction Guarantor (or a party of comparable financial strength, capacity and stability, as determined by Contracting Authority acting in its sole discretion) and in the form of guarantee attached as Schedule 29 – Form of Performance Guarantee of Construction Guarantor, is in place and enforceable by Contracting Authority.

45. TITLE

45.1 Title

- (a) Title to each item and part of the New Metrolinx Infrastructure or the New Third Party Infrastructure, including any materials, supplies, equipment, facilities, parts and any other deliverable or component items, but not the risk of loss or damage or destruction thereto or thereof, shall pass to Contracting Authority (or as Contracting Authority may direct) upon the receipt of such item on the Lands, provided however that title to items of tangible personal property (personal property that can be seen, weighed, measured, felt or touched or that is in any way perceptible to the senses and includes computer programs, natural gas and manufactured gas) that comprise the New Metrolinx Infrastructure and the New Third Party Infrastructure or are to be affixed or attached to the New Metrolinx Infrastructure and the New Third Party Infrastructure prior to Substantial Completion shall pass to Contracting Authority (or as Contracting Authority may direct) at the time that such items are included in the New Metrolinx Infrastructure and the

New Third Party Infrastructure or are to be affixed or attached to the New Metrolinx Infrastructure and the New Third Party Infrastructure.

46. INDEMNITIES

46.1 Project Co Indemnities to Contracting Authority

(a) Project Co shall indemnify and save harmless Contracting Authority and the Province Persons and each of their respective directors, officers, employees, agents and representatives from and against any and all Direct Losses which may be suffered, sustained, incurred or brought against them as a result of, in respect of, or arising out of any one or more of the following:

(i) a failure by Project Co to achieve:

(A) Interim Completion by the Scheduled Interim Completion Date; and/or

(B) Substantial Completion by the Scheduled Substantial Completion Date;

(ii) any physical loss of or damage to all or any part of the Lands, lands owned by Metrolinx that are adjacent to the Lands (but that are not Metrolinx Lands), the New Metrolinx Infrastructure, the New Third Party Infrastructure, the Existing Infrastructure, or to any equipment, assets or other property related thereto;

(iii) the death or personal injury of any person;

(iv) any physical loss of or damage to property or assets of any third party, including, for clarity, any physical loss of or damage to Existing Third Party Infrastructure, or New Third Party Infrastructure;

(v) any other loss or damage of any third party;

(vi) any fines or penalties levied or imposed under Applicable Law with respect to privacy; or

(vii) Injurious Affection claims made by third parties,

in the case of Sections 46.1(a)(i) to 46.1(a)(vi), arising, directly or indirectly, out of, or in consequence of, or involving or relating to, the performance or any breach of this Project Agreement by Project Co or any act or omission of Project Co or any Project Co Party, and in the case of Section 46.1(a)(vii), arising, directly or indirectly, out of, or in consequence of, or involving or relating to, any breach of this Project Agreement by Project Co or any Project Co Party, except to the extent caused, or contributed to, by:

(viii) the breach of this Project Agreement by Contracting Authority; or

(ix) in respect of Section 46.1(a)(i), any deliberate or negligent act or omission of Contracting Authority or any Province Person; or

(x) in respect of Sections 46.1(a)(ii), 46.1(a)(iii), 46.1(a)(iv), or 46.1(a)(v), any act or omission of Contracting Authority or any Province Person.

- (b) Project Co shall indemnify and save harmless Contracting Authority and each of their directors, officers, employees, agents and representatives from and against any and all Direct Losses which may be suffered, sustained, incurred or brought against them as a result of, in respect of, or arising out of any breach of a representation or warranty by Project Co herein.
- (c) Project Co shall indemnify and save harmless Contracting Authority and each of their directors, officers, employees, agents and representatives from and against any and all Direct Losses which may be suffered, sustained, incurred or brought against them as a result of, in respect of, arising out of, or involving or relating to any one or more of the following:
 - (i) the performance by Project Co of this Project Agreement not in accordance with or in breach of the requirements of any Permits, Licences, Approvals and Agreements, Applicable Law or requirements of Governmental Authorities, or the failure of Project Co to obtain all necessary Project Co Permits, Licences, Approvals and Agreements in accordance with this Project Agreement;
 - (ii) any Contamination on, in or under, or migrating to or from, the Lands, except for Contamination for which Contracting Authority is responsible pursuant to Section 18.2(a); or
 - (iii) the provision of assistance by Contracting Authority to Project Co pursuant to Section 11.13(d),

except to the extent that such Direct Losses are caused, or contributed to, by the breach of this Project Agreement by Contracting Authority or by any act or omission of Contracting Authority or any Contracting Authority Party.

- (d) Without prejudice to Contracting Authority's rights under Section 36 and any other rights under this Project Agreement, if Contracting Authority exercises its step-in rights under the Construction Contractor's Direct Agreement, Project Co shall indemnify Contracting Authority for all obligations of Project Co assumed by Contracting Authority under the Design and Construction Contract, as the case may be, and for all reasonable costs and expenses incurred by Contracting Authority in relation to the exercise of Contracting Authority's rights.
- (e) Project Co shall indemnify Contracting Authority for damages suffered or incurred on account of (i) any payment not duly made by Project Co pursuant to the terms of this Project Agreement on the due date; (ii) any overpayment to or underpayment by Project Co; or (iii) an amount determined as payable by Project Co to Contracting Authority under Schedule 27 – Dispute Resolution Procedure, by payment of an amount equal to the Payment Compensation Amount calculated from day to day at a rate per annum from the day after the date on which payment was due, the day on which overpayment was made by Contracting Authority, or from the date identified (if any) applicable to an amount determined as payable by Project Co to Contracting Authority under Schedule 27 – Dispute Resolution Procedure, up to and including the date of payment.
- (f) Project Co shall defend, in accordance with the procedures of Section 46.3, and indemnify and save harmless Contracting Authority and the Province Persons, and any Governmental Authority and each of their respective directors, officers, employees, agents and representatives from and

against any and all Direct Losses which may be suffered, sustained, incurred or brought against them as a result of, in respect of, or arising out of any one or more of the following:

- (i) any breach of Section 41.3;
 - (ii) any claim, suit, action or proceeding by a person alleging that (x) any Intellectual Property licensed or assigned to and used by Contracting Authority, any Province Persons or any Governmental Authority pursuant to this Project Agreement; or (y) any Intellectual Property or other materials used by Project Co or any Project Co Party or any Subcontractor in the performance of the Works and the Project, infringes or misappropriates any Intellectual Property rights of that person, other than where such claim, suit, action or proceeding is directly caused by,
 - (A) the use of such Intellectual Property by Contracting Authority not in accordance with this Project Agreement or the applicable Technical Information; or
 - (B) the use of such Intellectual Property by Contracting Authority in combination with other products, software or equipment not supplied by or on behalf of Project Co or the Subcontractors and not authorized by any of them;
 - (iii) any claim, suit, action or proceeding arising out of the alleged infringement or misappropriation of any rights in or to any Project Data or Intellectual Property Rights or the use thereof by Contracting Authority Party, any Province Persons or any Governmental Authority or due to the use of any materials, machinery or equipment in connection with the Works infringes any rights in or to any Intellectual Property of a third party unless such infringement has arisen out of the use of any Project Data or Intellectual Property Rights by Contracting Authority otherwise than in accordance with the terms of this Project Agreement or the applicable Technical information; and
 - (iv) any claim, suit, action or proceeding by any Licensor alleging that Project Co or any Project Co Party or any Subcontractor has used any Contracting Authority Supplied Third Party Intellectual Property in breach of Sections 3.1(a)(ii), 3.1(b), 3.1(c) or 3.1(d) of Schedule 24 – Intellectual Property.
- (g) Without limiting and in addition to the obligations in Section 46.1(f), if, as a result of a claim under Section 46.1(f)(i) or Section 46.1(f)(ii), all or any part of any Intellectual Property licensed or assigned to and used by Contracting Authority pursuant to this Project Agreement; or any Intellectual Property or other materials used by Project Co or any Subcontractor in the performance of the Works and the Project (any or all of the foregoing the “**Infringing Material**”) becomes, or in Project Co’s opinion is likely to be, enjoined from use, Project Co will:
- (i) give Notice to Contracting Authority of the same; and
 - (ii) at its sole option and expense, either:
 - (A) procure for itself and Contracting Authority, to the extent required, the right to continue to use the infringing element or component of the Infringing Material as contemplated in this Project Agreement; or

- (B) modify the infringing element or component of the Infringing Material so that it is non-infringing without materially affecting the quality, performance and functionality of such infringing element or component, or replace the infringing element or component with a substitute of materially equivalent quality, performance and functionality.

46.2 Contracting Authority Indemnities to Project Co

- (a) Contracting Authority shall indemnify and save harmless Project Co and the Project Co Parties and each of their respective directors, officers, employees, agents and representatives from and against any and all Direct Losses which may be suffered, sustained, incurred or brought against them as a result of, in respect of, or arising out of any one or more of the following:
 - (i) the death or personal injury of any person arising, directly or indirectly, out of, or in consequence of, or involving or relating to, the performance or breach of this Project Agreement by Contracting Authority or any act or omission of any Province Person, except to the extent caused, or contributed to, by the breach of this Project Agreement by Project Co or by any act or omission of Project Co or any Project Co Party;
 - (ii) any physical loss of or damage to all or any part of any property or assets of Project Co or any Project Co Party, arising, directly or indirectly, out of, or in consequence of, or involving or relating to, breach of this Project Agreement by Contracting Authority or any deliberate or negligent act or omission of any Province Person, except to the extent caused, or contributed to, by the breach of this Project Agreement by Project Co or by any act or omission of Project Co or any Project Co Party; and
 - (iii) any physical loss of or damage to property or assets of any third party, or any other loss or damage of any third party, arising, directly or indirectly, out of, or in consequence of, or involving or relating to, breach of this Project Agreement by Contracting Authority or any deliberate or negligent act or omission of any Province Person, except to the extent caused, or contributed to, by the breach of this Project Agreement by Project Co or by any act or omission of Project Co or any Project Co Party,

provided that there shall be excluded from the indemnity given by Contracting Authority any liability for the occurrence of risks against which Project Co is required to insure under this Project Agreement to the extent of the proceeds available or that should have been available but for a failure by Project Co to comply with its obligations to properly insure under this Project Agreement.

- (b) IO shall indemnify and save harmless Project Co and its directors, officers, employees, agents and representatives from and against any and all Direct Losses which may be suffered, sustained, incurred or brought against them as a result of, in respect of, or arising out of any breach of a representation or warranty by IO set out in Section 6.2(a).
- (c) Metrolinx shall indemnify and save harmless Project Co and its directors, officers, employees, agents and representatives from and against any and all Direct Losses which may be suffered, sustained, incurred or brought against them as a result of, in respect of, or arising out of any breach of a representation or warranty by Metrolinx set out in Section 6.2(b).

- (d) Contracting Authority shall indemnify Project Co for damages suffered or incurred on account of (i) any payment not duly made by Contracting Authority pursuant to the terms of this Project Agreement on the due date; (ii) any overpayment to or underpayment by Contracting Authority; or (iii) an amount determined as payable by Contracting Authority to Project Co under Schedule 27 – Dispute Resolution Procedure, by payment of an amount equal to the Payment Compensation Amount calculated from day to day at a rate per annum from the day after the date on which payment was due, the day on which overpayment was made by Project Co, or from the date identified (if any) applicable to an amount determined as payable by Contracting Authority to Project Co under Schedule 27 – Dispute Resolution Procedure, up to and including the date of payment.

46.3 Conduct of Claims

- (a) This Section 46.3 shall apply to the conduct of claims, made by a third person against a Party having, or claiming to have, the benefit of an indemnity pursuant to this Project Agreement. The Party having, or claiming to have, the benefit of the indemnity is referred to as the “**Beneficiary**” and the Party giving the indemnity is referred to as the “**Indemnifier**”.
- (b) If the Beneficiary receives any Notice, demand, letter or other document concerning any claim for which it appears that the Beneficiary is, or may become entitled to, indemnification under this Section 46, the Beneficiary shall give written Notice to the Indemnifier as soon as reasonably practicable and in any event within 10 Business Days after receipt of the same. Such Notice shall specify with reasonable particularity, to the extent that information is available, the factual basis for the claim and the amount of the claim.
- (c) Subject to Sections 46.3(d), 46.3(e) and 46.3(f), on the giving of such Notice by the Beneficiary, where it appears that the Beneficiary is or may be entitled to indemnification from the Indemnifier in respect of all, but not part only, of the liability arising out of the claim, the Indemnifier shall (subject to providing the Beneficiary with a secured indemnity to the Beneficiary’s reasonable satisfaction against all costs and expenses that the Beneficiary may incur by reason of such action) be entitled to dispute the claim in the name of the Beneficiary at the Indemnifier’s own expense and take conduct of any defence, dispute, compromise, or appeal of the claim and of any incidental negotiations. The Beneficiary shall give the Indemnifier all reasonable cooperation, access and assistance for the purposes of considering and resisting such claim. The Beneficiary shall have the right to employ separate counsel in respect of such claim and the reasonable fees and expenses of such counsel shall be to the account of the Indemnifier only where representation of both the Indemnifier and Beneficiary by common counsel would be inappropriate due to any actual or potential conflicting interests between the Indemnifier and Beneficiary.
- (d) With respect to any claim conducted by the Indemnifier:
- (i) the Indemnifier shall keep the Beneficiary fully informed and consult with it about material elements of the conduct of the claim;
 - (ii) the Indemnifier shall not bring the name or reputation of the Beneficiary into disrepute;
 - (iii) the Indemnifier shall not pay, compromise or settle such claims without the prior consent of the Beneficiary, such consent not to be unreasonably withheld or delayed;

- (iv) the Indemnifier shall not admit liability or fault to any third party without the prior consent of the Beneficiary, such consent not to be unreasonably withheld or delayed; and
 - (v) the Indemnifier shall use commercially reasonable efforts to have the Beneficiary named as a beneficiary under any release given by the persons bringing the claim to which this Section 46.3 relates.
- (e) The Beneficiary shall be free to pay or settle any such claim on such terms as it thinks fit and without prejudice to its rights and remedies under this Project Agreement if:
- (i) the Indemnifier is not entitled to take conduct of the claim in accordance with Section 46.3(c);
 - (ii) the Indemnifier fails to notify the Beneficiary of its intention to take conduct of the relevant claim as soon as reasonably practicable and in any event within 10 Business Days following the Indemnifier's receipt of the Notice from the Beneficiary under Section 46.3(b) or notifies the Beneficiary that the Indemnifier does not intend to take conduct of the claim; or
 - (iii) the Indemnifier fails to comply in any material respect with Section 46.3(d).
- (f) The Beneficiary shall be free at any time to give Notice to the Indemnifier that the Beneficiary is retaining or taking over, as the case may be, the conduct of any defence, dispute, compromise or appeal of any claim, or of any incidental negotiations, to which Section 46.3(c) applies. For greater certainty, Project Co acknowledges and agrees that where Contracting Authority is the Beneficiary, Contracting Authority may retain or take over such conduct in any matter involving Personal Information or any matter involving public policy. On receipt of such Notice the Indemnifier shall promptly take all steps necessary to transfer the conduct of such claim to the Beneficiary, and shall provide to the Beneficiary all relevant documentation and all reasonable cooperation, access and assistance for the purposes of considering and resisting such claim. If the Beneficiary gives any Notice pursuant to this Section 46.3(f), then the Indemnifier shall be released from any liabilities arising under the applicable indemnity hereunder in respect of the applicable claim.
- (g) If the Indemnifier pays to the Beneficiary an amount in respect of an indemnity and the Beneficiary subsequently recovers, whether by payment, discount, credit, saving, relief or other benefit or otherwise, a sum or anything else of value (the "**Recovery Amount**") which is directly referable to the fact, matter, event or circumstances giving rise to the claim under the indemnity, the Beneficiary shall forthwith repay to the Indemnifier whichever is the lesser of:
- (i) an amount equal to the Recovery Amount less any out-of-pocket costs and expenses properly incurred by the Beneficiary in recovering the same; and
 - (ii) the amount paid to the Beneficiary by the Indemnifier in respect of the claim under the relevant indemnity,

provided that there shall be no obligation on the Beneficiary to pursue any Recovery Amount and that the Indemnifier is repaid only to the extent that the Recovery Amount, aggregated with any sum recovered from the Indemnifier, exceeds the loss sustained by the Beneficiary except,

however, that if the Beneficiary elects not to pursue a Recovery Amount, the Indemnifier shall be entitled to require an assignment to it of the right to do so.

- (h) Any person taking any of the steps contemplated by this Section 46.3 shall comply with the requirements of any insurer who may have an obligation to provide an indemnity in respect of any liability arising under this Project Agreement.

46.4 Mitigation – Indemnity Claims

- (a) For greater certainty, Section 54.4 applies to any indemnity given under this Project Agreement and any such indemnity shall not extend to Direct Losses which could have been reduced or avoided by the Beneficiary complying with such Section.

47. LIMITS ON LIABILITY

47.1 Indirect Losses

- (a) Subject to Section 47.1(b) and without prejudice to the Parties' rights in respect of payments provided for herein, the indemnities under this Project Agreement shall not apply and there shall be no right to claim damages for breach of this Project Agreement, in tort or on any other basis whatsoever, to the extent that any loss claimed by either Party is:

- (i) for punitive, exemplary or aggravated damages;
- (ii) for loss of profits, loss of use, loss of production, loss of business or loss of business opportunity;
- (iii) is a claim for consequential loss or for indirect loss of any nature suffered or allegedly suffered by either Party; or
- (iv) for damages sustained by Contracting Authority in respect of delay claims arising from delay to a subsequent project that is managed or controlled by Contracting Authority that is caused by Project Co failing to achieve Substantial Completion by the Scheduled Substantial Completion Date,

(collectively, "**Indirect Losses**").

- (b) With respect to the indemnity in Section 46.1(a)(i) only, the exceptions in Sections 47.1(a)(ii) and (iii) shall not apply as a result of, or in relation to, Contracting Authority's loss of use of the New Metrolinx Infrastructure, the New Third Party Infrastructure and/or the Existing Infrastructure or a portion thereof, which for the purposes of Section 46.1(a)(i), shall be Direct Losses.
- (c) With respect to the indemnity in Section 46.1(a)(v) only, the exceptions in Sections 47.1(a)(ii) and 47.1(a)(iii) shall not apply as a result of, or in relation to, CP's loss of use of the Rail Corridor, including any CP Train Delay, which, for the purposes of Section 46.1(a)(v), shall be Direct Losses.

47.2 No Liability in Tort

- (a) Subject to the indemnities provided herein, neither Contracting Authority nor any Province Persons shall be liable in tort to Project Co or any Project Co Party, and neither Project Co nor any Project Co Party shall be liable in tort to Contracting Authority or any Province Person in respect of any negligent act or omission of any such person relating to or in connection with this Project Agreement and no such person shall bring such a claim.

47.3 Sole Remedy

- (a) Nothing in this Project Agreement shall prevent or restrict the right of Contracting Authority to seek injunctive relief or a decree of specific performance or other discretionary remedies of a court of competent jurisdiction.
- (b) Notwithstanding any other provision of this Project Agreement, and except to the extent recovered under any of the insurances required pursuant to Schedule 25 – Insurance and Performance Security Requirements, neither Party shall be entitled to recover compensation or make a claim under this Project Agreement, or any other agreement in relation to the Project, in respect of any loss that it has incurred (or any failure of the other Party) to the extent that the Party has already been compensated in respect of that loss or failure pursuant to this Project Agreement, or otherwise.
- (c) The following shall apply with respect to the deductions and liquidated damages set out in the Project Agreement:
- (i) the liquidated damages paid by Project Co pursuant to Section 2.3(c) shall be Contracting Authority’s sole remedy for Project Co’s failure to deliver to Contracting Authority any of the documents referred to in Section 1 of Schedule 2 – Completion Documents by the Financial Close Target Date (other than as a direct result of a breach by Contracting Authority of its obligations under Section 2.3(b)(ii)) if Contracting Authority does not waive such requirement;
 - (ii) the liquidated damages paid by Project Co pursuant to Sections 3.1(a) and 3.1(b) of Schedule 21 – Liquidated Damages and Construction Enforcement Regime shall be Contracting Authority’s sole remedy for Specified Costs and for the costs related to customer ticket refunds in circumstances where Project Co has caused an individual GO Train Delay, but shall not be Contracting Authority’s sole remedy with respect to amounts that are not Specified Costs or costs related to customer ticket refunds;
 - (iii) the liquidated damages paid by Project Co pursuant to Sections 3.1(c) and 3.1(d) of Schedule 21 – Liquidated Damages and Construction Enforcement Regime shall be Contracting Authority’s sole remedy for Specified Costs and for the costs related to customer ticket refunds in circumstances where Project Co has caused an individual Train Cancellation, but shall not be Contracting Authority’s sole remedy with respect to amounts that are not Specified Costs or costs related to customer ticket refunds;
 - (iv) the liquidated damages paid by Project Co pursuant to Section 3.1(e) of Schedule 21 – Liquidated Damages and Construction Enforcement Regime shall be Contracting Authority’s sole remedy with respect to Specified Costs for a GO Train Rerouting Event,

- but shall not be Contracting Authority's sole remedy with respect to amounts that are not Specified Costs;
- (v) the liquidated damages paid by Project Co pursuant to Section 3.2(a) of Schedule 21 – Liquidated Damages and Construction Enforcement Regime shall be Contracting Authority's sole remedy for the Specified Costs for an individual Failure to Vacate, but shall not be Contracting Authority's sole remedy with respect to amounts that are not Specified Costs;
 - (vi) the liquidated damages paid by Project Co pursuant to Section 3.2(b) of Schedule 21 – Liquidated Damages and Construction Enforcement Regime shall be Contracting Authority's sole remedy for the Specified Costs for an individual Cancelled Major Track Closure, but shall not be Contracting Authority's sole remedy with respect to amounts that are not Specified Costs;
 - (vii) the liquidated damages paid by Project Co pursuant to Section 3.3 of Schedule 21 – Liquidated Damages and Construction Enforcement Regime shall be Contracting Authority's sole remedy for Specified Costs and for the costs related to a CP Train Delay but shall not be Contracting Authority's sole remedy with respect to amounts that are not Specified Costs;
 - (viii) the liquidated damages paid by Project Co pursuant to Section 4.1(a) of Schedule 21 – Liquidated Damages and Construction Enforcement Regime shall be Contracting Authority's sole remedy for the Specified Costs arising from Project Co's failure to provide the applicable Key Individual Category A in accordance with Section 12.4(a), but shall not be Contracting Authority's sole remedy with respect to amounts that are not Specified Costs;
 - (ix) the liquidated damages paid by Project Co pursuant to Section 4.1(b) of Schedule 21 – Liquidated Damages and Construction Enforcement Regime shall be Contracting Authority's sole remedy for the Specified Costs arising from Project Co's failure to replace the applicable Key Individual Category A in accordance with Section 12.4(b) but shall not be Contracting Authority's sole remedy with respect to amounts that are not Specified Costs;
 - (x) the liquidated damages paid by Project Co pursuant to Section 4.2 of Schedule 21 – Liquidated Damages and Construction Enforcement Regime shall be the sole remedy of Contracting Authority and Province Persons for Specified Costs that may be claimed by Contracting Authority and Province Persons as a result of Project Co failing to achieve the requirements for the Interim Completion Certificate and an Interim Completion Certificate not being issued on or before the Interim Completion LD Commencement Date, but shall not be Contracting Authority's sole remedy with respect to amounts that are not Specified Costs in connection with Project Co failing to achieve the requirements for the Interim Completion Certificate and an Interim Completion Certificate not being issued on or before the Interim Completion LD Commencement Date;
 - (xi) the liquidated damages paid by Project Co pursuant to Section 4.3 of Schedule 21 – Liquidated Damages and Construction Enforcement Regime shall be the sole remedy of Contracting Authority and Province Persons for Specified Costs that may be claimed by

Contracting Authority and Province Persons as a result of Project Co failing to achieve the requirements for the Substantial Completion Certificate and a Substantial Completion Certificate not being issued on or before the Substantial Completion LD Commencement Date, but shall not be Contracting Authority's sole remedy with respect to amounts that are not Specified Costs in connection with Project Co failing to achieve the requirements for the Substantial Completion Certificate and a Substantial Completion Certificate not being issued on or before the Substantial Completion LD Commencement Date; and

- (xii) the amounts deducted from the Substantial Completion Payment pursuant to Section 5 of Schedule 21 – Liquidated Damages and Construction Enforcement Regime shall not be Contracting Authority's sole remedy in respect of Project Co's failure to perform its obligations in accordance with the Project Agreement.

47.4 Maximum Liability

- (a) Subject to Section 47.4(b), the maximum aggregate liability of each Party in respect of all claims under Section 46 shall not exceed \$[REDACTED]. This limit shall be index linked and shall be exclusive of any insurance or performance security proceeds received or which will be received pursuant to performance security or policies maintained in accordance with Schedule 25 – Insurance and Performance Security Requirements. This limit shall not apply in cases of wilful misconduct or deliberate acts of wrongdoing.
- (b) Project Co's maximum aggregate liability in respect of all claims under Section 46.1(a)(i) shall not exceed \$[REDACTED]. This limit shall be index linked and shall be exclusive of any insurance or performance security proceeds received or which will be received pursuant to performance security or policies maintained in accordance with Schedule 25 – Insurance and Performance Security Requirements. This limit shall not apply in cases of wilful misconduct or deliberate acts of wrongdoing.
- (c) Nothing in this Section 47.4 shall restrict, limit, prejudice or in any other way impair the rights and/or remedies of the Parties under any other provision of this Project Agreement.

48. DISPUTE RESOLUTION PROCEDURE

- (a) All Disputes shall be resolved in accordance with, and the Parties shall comply with, Schedule 27 – Dispute Resolution Procedure.

49. ASSIGNMENT, SUBCONTRACTING AND CHANGES IN CONTROL

49.1 Project Co Assignment

- (a) Project Co shall not sell, assign, transfer, charge, mortgage, encumber, dispose of or otherwise alienate all or any part of any interest, whether legal or beneficial, in this Project Agreement or any Ancillary Document without the prior written consent of Contracting Authority, which consent may be withheld in the sole discretion of Contracting Authority, provided however that no assignment, transfer, charge, disposition or other alienation shall be permitted to a person where that person or its Affiliate is a Restricted Person or a person whose standing or activities may compromise (i) Contracting Authority's reputation or integrity, or (ii) the nature of the public

transit system in the Municipality or the Province of Ontario so as to affect public confidence in the public transit system in the Municipality, the Province of Ontario or the Project.

- (b) Section 49.1(a) shall not apply to the grant of any security for any loan made to Project Co under the Lending Agreements provided that any grantee of such security shall enter into the Lenders' Direct Agreement in relation to the exercise of its rights, if Contracting Authority so requires.

49.2 Contracting Authority Assignment

- (a) Contracting Authority may assign, transfer, dispose of or otherwise alienate any interest in this Project Agreement or any agreement in connection with this Project Agreement to which Project Co and Contracting Authority are parties:

- (i) to the Province;
- (ii) as may be required to comply with Applicable Law;
- (iii) to any minister of the Province;
- (iv) to an agency of the Province having the legal capacity, power, authority and ability to become a party to and to perform the obligations of Contracting Authority under this Project Agreement provided that such person confirms in writing to Project Co that it will perform all of Contracting Authority's obligations hereunder and under the other Project Documents to which Contracting Authority is a party in respect of the period from and after the assignment; and
- (v) in circumstances other than those described in Sections 49.2(a)(i) to 49.2(a)(iv) with the prior written consent of Project Co; provided that the person to whom any such assignment, transfer, disposition or other alienation is made has the capacity to perform, and confirms in writing to Project Co that it will perform all the obligations of Contracting Authority hereunder and under any agreement in connection with this Project Agreement to which Project Co and Contracting Authority are parties in respect of the period from and after the assignment.

- (b) Contracting Authority shall not be released of any of its obligations under this Project Agreement except upon an assignment, transfer, disposition or other alienation of their interest in this Project Agreement in accordance with this Section 49.2.

49.3 Subcontracting

- (a) Project Co shall not subcontract any interest in this Project Agreement or the Design and Construction Contract, and shall not permit the Construction Contractor to subcontract any interest in the Design and Construction Contract, to a Restricted Person, or any Affiliate thereof, or a person whose standing or activities may compromise (i) Contracting Authority's reputation or integrity, or (ii) the nature of the public transit system in the Municipality or the Province of Ontario so as to affect public confidence in the public transit system in the Municipality, the Province of Ontario or the Project.

- (b) Project Co shall not terminate, agree to the termination of or replace the Construction Contractor unless Project Co has complied with Sections 8.2(a), 49.3(c) and 49.3(d) or received the prior written consent of Contracting Authority.
- (c) Subject to Section 49.3(d), if the Design and Construction Contract shall at any time lapse, terminate or otherwise cease to be in full force and effect, whether by reason of expiry, default or otherwise, with the effect that the Construction Contractor shall cease to act in relation to the Project, Project Co shall forthwith appoint a replacement, subject to Contracting Authority's prior written consent, acting reasonably, as to the suitability of the replacement.
- (d) It is a condition of replacement of the Construction Contractor, and Project Co shall require, that any replacement enter into a contract upon the same or substantially similar terms as the person so replaced and into a direct agreement on the same terms as the Construction Contractor's Direct Agreement entered into by the person so replaced, unless any material variations are approved by Contracting Authority, acting reasonably.

49.4 Changes in Ownership and Control

- (a) No Restricted Person or a person whose standing or activities are inconsistent with the Province's reputation or integrity shall be permitted to have at any time or acquire, Direct or Indirect Power or Control over any member of the Project Co Group in relation to the decisions, management, actions or policies of Project Co or in relation to the operation, management and ownership of the Project.
- (b) No Change in Ownership of Project Co, or of any Control Party, shall be permitted:
 - (i) where the person acquiring the ownership interest is a Restricted Person or a person whose standing or activities may compromise (A) Contracting Authority's reputation or integrity, or (B) the nature of the public transit system in the Municipality or the Province of Ontario so as to affect public confidence in the public transit system in the Municipality, the Province of Ontario or the Project; or
 - (ii) if such Change in Ownership would have a material adverse effect on the performance of the Works or the Governmental Activities.
- (c) In the event that a person having Direct or Indirect Power or Control over any member of the Project Co Group in relation to the decisions, management, actions or policies of Project Co or in relation to the operation, management and ownership of the Project becomes a Restricted Person, Contracting Authority may:
 - (i) in the case of an individual who becomes a Restricted Person, require that such Restricted Person be divested of his or her Direct or Indirect Power or Control; or
 - (ii) in any other circumstance, require a Change in Ownership so that the Restricted Person shall be divested of its Direct or Indirect Power or Control,

in each case, on such terms as are satisfactory to Contracting Authority's, in its discretion.

- (d) Project Co shall provide Notice to Contracting Authority of any Change in Ownership of Project Co or of any Control Party, as the case may be, that is not a Change in Control within five Business Days after such Change in Ownership, and such Notice shall include a statement identifying all persons with an ownership interest in Project Co or the relevant Control Party, as the case may be, and their respective holdings of such ownership interests, in each case prior to and following such Change in Ownership.
- (e) Subject to Sections 49.4(a), 49.4(b), 49.4(c) and 49.4(d), no Change in Control of Project Co, or of any Control Party, shall be permitted without the prior written consent of Contracting Authority.
- (f) Project Co shall provide Notice to Contracting Authority of any proposed Change in Control of Project Co or of any Control Party, as the case may be, not less than 20 Business Days prior to such proposed Change in Control, and such Notice shall include:
 - (i) a statement identifying all persons with an ownership interest in Project Co or the relevant Control Party, as the case may be, and their respective holdings of such ownership interests in each case prior to and following any such proposed Change in Control; and
 - (ii) as applicable, the legal name, registered address, directors and officers of, and nature of the business and activities carried on by, the person who would acquire control over Project Co or the relevant Control Party pursuant to such Change in Control.

Following the delivery to Contracting Authority of the Notice referred to in this Section 49.4(f), Project Co shall provide Contracting Authority with such other information pertaining to the proposed Change in Control as Contracting Authority may reasonably request.

- (g) Upon request by Project Co and delivery of the information required by Contracting Authority, Contracting Authority shall advise Project Co whether the person described in such particulars is a Restricted Person or a person whose standing or activities may compromise (i) Contracting Authority's reputation or integrity, or (ii) the nature of the public transit system in the Municipality or the Province of Ontario so as to affect public confidence in the public transit system in the Municipality, the Province of Ontario or the Project.
- (h) Notwithstanding the definition of "Control Parties" set out Schedule 1 – Definitions and Interpretation, this Section 49.4 shall not apply to a Change in Ownership or Change in Control of persons whose equity securities or units evidencing ownership or any other ownership interests are listed on a recognized stock exchange.
- (i) Section 49.4(d) shall not apply to a Change in Ownership of a Control Party that arises from a change in the shareholdings of such Control Party or an Affiliate of such Control Party (the "**Relevant Entity**") owned by an employee of such Relevant Entity, unless such changes individually or in the aggregate determined since the date of this Project Agreement, would result in a Change of Control of Project Co, in which case Section 49.4(f) shall apply.

49.5 Contracting Authority's Due Diligence

- (a) Project Co shall promptly reimburse Contracting Authority for Contracting Authority's reasonable due diligence costs (including fees of professional advisors) in connection with any consent

required of Contracting Authority pursuant to, or Contracting Authority's determination of Project Co's compliance with, Sections 49.1, 49.3 or 49.4, whether or not such consent is granted.

50. PROHIBITED ACTS

50.1 Definition

(a) The term "**Prohibited Act**" means:

- (i) offering, giving or agreeing to give to Contracting Authority or any public body (or anyone employed by or acting on their behalf), or to any family member of such person, any gift or consideration of any kind as an inducement or reward:
 - (A) for doing or not doing, or for having done or not having done, any act in relation to the obtaining or performance of this Project Agreement or any other agreement with Contracting Authority or any public body in connection with the Project; or
 - (B) for showing or not showing favour or disfavour to any person in relation to this Project Agreement or any other agreement with Contracting Authority or any public body in connection with the Project,

provided that this Section 50.1(a)(i) shall not apply to Project Co or any Project Co Party (or anyone employed by or acting on their behalf) providing consideration to Contracting Authority or any public body in the ordinary course, or as reasonably necessary, to fulfill or comply with the obligations and liabilities of Project Co under this Project Agreement or any other agreement with Contracting Authority or any public body in connection with the Project;

- (ii) entering into this Project Agreement or any other agreement with Contracting Authority or any public body in connection with the Project if a commission or a fee has been paid or has been agreed to be paid by Project Co, or on its behalf or to its knowledge, Contracting Authority or any public body (or anyone employed by or acting on their behalf), or to any family member of such person, unless, before the relevant agreement is entered into, particulars of any such commission or fee have been disclosed in writing to Contracting Authority, provided that this Section 50.1(a)(ii) shall not apply to a fee or commission paid by Project Co or any Project Co Party (or anyone employed by or acting on their behalf) to Contracting Authority or any public body pursuant to an agreement where such fee or commission is paid in the ordinary course, or as reasonably necessary, to fulfill or comply with the obligations and liabilities of Project Co under this Project Agreement or any other agreement with Contracting Authority or any public body in connection with the Project without contravening the intent of this Section 50;
- (iii) breaching or committing any offence under Applicable Law in respect of corrupt or fraudulent acts in relation to this Project Agreement or any other agreement with Contracting Authority or any public body in connection with the Project; or
- (iv) defrauding or attempting to defraud or conspiring to defraud Contracting Authority or any other public body.

50.2 Remedies

- (a) If Project Co or any Project Co Party (or anyone employed by or acting on their behalf) commits any Prohibited Act, then Contracting Authority shall be entitled to act in accordance with the following:
- (i) if the Prohibited Act is committed by Project Co or by an employee acting under the direction of a director or officer of Project Co, then Contracting Authority may give written Notice to Project Co and Section 36 shall apply;
 - (ii) if the Prohibited Act is committed by an employee of Project Co acting independently of a direction of a director or officer of Project Co, then Contracting Authority may give written Notice to Project Co and Section 36 shall apply, unless, within 30 days after receipt of such Notice, Project Co terminates the employee's employment and ensures that the relevant part of the Works shall be performed by another person;
 - (iii) if a Prohibited Act is committed by a Project Co Party or by an employee of that Project Co Party not acting independently of a direction of a director or officer of that Project Co Party, then Contracting Authority may give written Notice to Project Co and Section 36 shall apply, unless, within 30 days after receipt of such Notice, Project Co terminates the relevant Subcontract and ensures that the relevant part of the Works shall be performed by another person, where relevant, in accordance with Section 49.3;
 - (iv) if the Prohibited Act is committed by an employee of a Project Co Party acting independently of a direction of a director or officer of that Project Co Party, then Contracting Authority may give Notice to Project Co and Section 36 shall apply, unless, within 30 days after receipt of such Notice, Project Co causes the termination of the employee's employment and ensures that the relevant part of the Works shall be performed by another person; and
 - (v) if the Prohibited Act is committed on behalf of Project Co or a Project Co Party by a person not specified in Sections 50.2(a)(i) to 50.2(a)(iv), then Contracting Authority may give Notice to Project Co and Section 36 shall apply, unless, within 30 days after receipt of such Notice, Project Co causes the termination of such person's employment or the appointment of their employer and, if necessary, ensures that the relevant part of the Works shall be performed by another person.
- (b) Any Notice of termination under this Section 50.2 shall specify:
- (i) the nature of the Prohibited Act;
 - (ii) the identity of the person whom Contracting Authority believes has committed the Prohibited Act; and
 - (iii) the date of termination in accordance with the applicable provisions of this Project Agreement.

- (c) Without prejudice to its other rights or remedies under this Section 50.2, Contracting Authority shall be entitled to recover from Project Co any Direct Loss sustained in consequence of any breach of this Section 50.

50.3 Permitted Payments

- (a) Nothing contained in this Section 50 shall prevent Project Co or any other person from paying any proper commission, fee or bonus whether to its employees within the agreed terms of their employment or otherwise, and such commission fee or bonus shall not constitute a Prohibited Act.

50.4 Notification

- (a) Project Co shall notify Contracting Authority of the occurrence and details of any Prohibited Act promptly on Project Co becoming aware of its occurrence.

50.5 Replacement of Project Co Party

- (a) Where Project Co is required to replace any Project Co Party pursuant to this Section 50, the party replacing such Project Co Party shall from the time of the replacement be deemed to be a Project Co Party and the provisions of this Project Agreement shall be construed accordingly.

51. NOTICES

51.1 Notices to Parties

- (a) All notices, requests, demands, instructions, certificates, consents and other communications (each being a “**Notice**”) required or permitted under this Project Agreement shall be in writing (whether or not “written notice” or “notice in writing” is specifically required by the applicable provision of this Project Agreement) and served by sending the same by registered mail, facsimile or by hand (in each case with a copy by electronic submission), as follows:

If to Project Co:

[REDACTED]

Fax No.: [REDACTED]

Email: [REDACTED]

Attn.: [REDACTED]

with a copy to:

Email: [REDACTED]

Attn.: [REDACTED]

If to IO:

[REDACTED]

Fax No.: [REDACTED]

Attn.: [REDACTED]

If to Metrolinx: [REDACTED]

Fax No.: [REDACTED]
Attn.: [REDACTED]

with a copy to:

[REDACTED]

Fax No.: [REDACTED]
Attn.: [REDACTED]

51.2 Notices to Representatives

- (a) In addition to the Notice requirements set out in Section 51.1, where any Notice is to be provided or submitted to the Contracting Authority Representative or the Project Co Representative it shall be provided or submitted by sending the same by registered mail, facsimile or by hand, as follows:

If to Project Co Representative: [REDACTED]

Fax No.: [REDACTED]
Email: [REDACTED]
Attn.: [REDACTED]

If to the Contracting Authority Representative: [REDACTED]

Fax No.: [REDACTED]
Email: [REDACTED]
Attn.: [REDACTED]

51.3 Facsimile

- (a) Where any Notice is provided or submitted to a Party via facsimile, an original of the Notice sent via facsimile shall promptly be sent by regular mail or registered mail. For greater certainty, a Notice given via facsimile shall not be invalid by reason only of a Party's failure to comply with this Section 51.3.

51.4 Change of Address

- (a) Either Party to this Project Agreement may, from time to time, change any of its contact information set forth in Sections 51.1 or 51.2 by prior Notice to the other Party, and such change shall be effective on the Business Day that next follows the recipient Party's receipt of such Notice unless a later effective date is given in such Notice.

51.5 Deemed Receipt of Notices

- (a) Subject to Sections 51.5(b), 51.5(c) and 51.5(d):
- (i) a Notice given by registered mail shall be deemed to have been received on the third Business Day after mailing;

- (ii) a Notice given by hand delivery shall be deemed to have been received on the day it is delivered; and
 - (iii) a Notice given by facsimile shall be deemed to have been received on the day it is transmitted by facsimile.
- (b) If the Party giving the Notice knows or ought reasonably to know of difficulties with the postal system which might affect negatively the delivery of mail, any such Notice shall not be mailed but shall be made or given by personal delivery or by facsimile transmission in accordance with this Section 51.
- (c) If any Notice delivered by hand or transmitted by facsimile is so delivered or transmitted, as the case may be, either on a day that is not a Business Day or on a Business Day after 4:00 p.m. (recipient's local time), then such Notice shall be deemed to have been received by such recipient on the next Business Day.
- (d) A Notice given by facsimile shall be deemed to have been received by the recipient on the day it is transmitted only if a facsimile transmission report (maintained by the sender) indicates that the transmission of such Notice was successful.

51.6 Service on Contracting Authority

- (a) Where any Notice is required to be served on Contracting Authority, the obligation to serve such Notice shall be fulfilled by serving it on Contracting Authority in accordance with the provisions of this Section 51.

52. EMERGENCY MATTERS

52.1 Emergency

- (a) From Financial Close until Substantial Completion Date, upon the occurrence of an Emergency, Project Co shall comply with the Contractor Site Specific Safety Manual.
- (b) From and after Substantial Completion Date, upon the occurrence of an Emergency, Project Co shall comply with its Contractor Site Specific Safety Manual in accordance with the Output Specifications.
- (c) If, in respect of any Emergency, Contracting Authority notifies Project Co that it requires compliance with any additional or overriding procedures as may be determined by Contracting Authority or any other statutory body, then Project Co shall, subject to Schedule 22 – Variation Procedure (if compliance with such procedures constitutes a Variation), comply with such procedures (whether such procedures are specific to the particular Emergency or of general application and on the basis that such procedures shall take precedence to the extent that they overlap with the procedures mentioned in Sections 52.1(a) or 52.1(b)).

53. CONTRACTING AUTHORITY'S DESIGNATE

53.1 Right to Designate

- (a) At any time and from time to time, the Crown may designate any ministry, branch, agency, division, department or office of the Government of Ontario to carry out administrative responsibility for the rights and obligations of Contracting Authority under this Project Agreement (including review of all documentation submitted by Project Co, a Project Co Representative or a Project Co Party to Contracting Authority for review, approval, comment, evaluation or otherwise as described in this Project Agreement, engagement in discussions, consultations and meetings with Project Co, submission of Notices and documentation to Contracting Authority, issuances of Notices, documentation, Variation Confirmations and related matters) and Project Co may deal exclusively with the designated person in respect of all such matters and is entitled to rely on the actions, directions, requests, Notices, consents, approvals, waivers, and comments relating to the review of documentation and other administrative matters and decisions determined by such designated person from time to time, until the Crown has notified Project Co in writing that such designated person is no longer the person designated by the Crown hereunder and such Notice shall have effect on the later of the date of delivery of such Notice and the date specified in the written Notice. The Crown shall advise Project Co in writing of any designation hereunder. The rights and obligations of the parties to this Project Agreement shall be in no way affected by reason of any such designation. Project Co acknowledges the right of the Crown to delegate administrative responsibilities hereunder as set forth in this Section 53.1.

54. GENERAL

54.1 Amendments

- (a) This Project Agreement may not be varied, amended or supplemented except by an agreement in writing signed by duly authorized representatives of the Parties and stating on its face that it is intended to be an amendment, restatement or other modification, as the case may be, to this Project Agreement.

54.2 Waiver

- (a) No waiver made or given by a Party under or in connection with this Project Agreement shall be binding or effective unless the waiver is in writing, signed by an authorized representative of the Party giving such waiver, and delivered by such Party to the other Parties. No waiver made with respect to any right, power or remedy in one instance will be deemed to be a waiver with respect to any other instance involving the exercise of such right, power, or remedy or with respect to any other right, power, or remedy.
- (b) Failure by either Party to exercise any of its rights, powers or remedies hereunder or its delay to do so shall not constitute a waiver of those rights, powers or remedies. The single or partial exercise of a right, power or remedy shall not prevent its subsequent exercise or the exercise of any other right, power or remedy.

54.3 Relationship Between the Parties

- (a) The Parties are independent contractors. This Project Agreement is not intended to and does not create or establish between the Parties, or between Contracting Authority and any Project Co Party, any relationship as partners, joint venturers, employer and employee, master and servant, or (except as provided in this Project Agreement), of principal and agent, and does not create or establish any relationship whatsoever between Contracting Authority and any representative or employee of Project Co or the Project Co Parties.
- (b) The Parties further agree that:
 - (i) except as expressly provided in this Project Agreement, neither Party shall be, or be deemed to be, an agent of the other Party, and neither Party shall have authority hereunder to represent that it is an agent of the other Party, or to accept any order, or enter into any contract or agreement, or make any representations or warranties of any kind to any person, or to assume or create any obligation, express or deemed, on behalf of or binding, or purportedly binding upon, the other Party;
 - (ii) neither Party shall be required to make or pay employment benefits, contributions for Employment Insurance, Canada Pension Plan, Workers' Compensation Board or other similar levies with respect to any persons employed or engaged by the other Party;
 - (iii) except as otherwise expressly provided in this Project Agreement, each Party shall be free from the control of the other Party as to the manner in which it shall perform its obligations, or cause same to be performed, under this Project Agreement; and
 - (iv) any person which a Party may engage as an agent, employee, subcontractor or otherwise, to perform such Party's obligations under this Project Agreement, as permitted hereby, shall, unless the Parties otherwise agree in writing, be engaged by such Party to act solely on behalf of such Party, and such person shall not act, or be deemed to act, on behalf of the Party that did not engage its services.

54.4 General Duty to Mitigate

- (a) Contracting Authority and Project Co shall at all times take commercially reasonable steps to minimize and mitigate any loss for which the relevant Party is entitled to bring a claim against the other Party pursuant to this Project Agreement.

54.5 Actual Knowledge

- (a) Except where limited to actual knowledge and/or such knowledge which they, at law, may from time to time, be deemed to have, Project Co and Contracting Authority shall, for all purposes of this Project Agreement, be deemed to have such knowledge in respect of the Project as is actually held (or ought reasonably to be held) by the directors, officers and senior management of Project Co and in the case of Contracting Authority, its directors, officers and senior management, and the Contracting Authority Representative or the Project Co Representative, as applicable. For clarity, except as expressly set out to the contrary, a reference in this Project Agreement to the "knowledge" of Project Co or of Contracting Authority shall be construed in a manner consistent with the foregoing sentence.

54.6 Entire Agreement

- (a) Except where provided otherwise in this Project Agreement, this Project Agreement constitutes the entire agreement between the Parties in connection with its subject matter and supersedes all prior representations, communications, negotiations and understandings, whether oral, written, express or implied, concerning the subject matter of this Project Agreement.

54.7 No Reliance

- (a) Each of the Parties acknowledge that:
 - (i) it has not entered into this Project Agreement on the basis of and does not rely, and has not relied, upon any statement or representation, whether negligent or innocent, or warranty or other provision, whether oral, written, express or implied, made or agreed to by any person, whether a Party to this Project Agreement or not, except those expressly made, given or repeated in this Project Agreement and the only remedy or remedies available in respect of any misrepresentation or untrue statement made to it shall be those expressly provided for in this Project Agreement; and
 - (ii) this Section 54.7 shall not apply to any statement, representation or warranty made fraudulently, or to any provision of this Project Agreement which was induced by fraud, for which the remedies available shall be all those available under the law governing this Project Agreement.

54.8 Severability

- (a) Each provision of this Project Agreement shall be valid and enforceable to the fullest extent permitted by law. If any provision of this Project Agreement is declared invalid, unenforceable or illegal by the courts of a competent jurisdiction, such provision may be severed and such invalidity, unenforceability or illegality shall not prejudice or affect the validity, enforceability and legality of the remaining provisions of this Project Agreement. If any such provision of this Project Agreement is invalid, unenforceable or illegal, the Parties shall, acting in good faith, promptly negotiate new provisions to eliminate such invalidity, unenforceability or illegality and to restore this Project Agreement as near as possible to its original intent and effect.

54.9 Enurement

- (a) This Project Agreement and any other agreement entered into in connection with the Project to which both Contracting Authority and Project Co are parties shall enure to the benefit of, and be binding on, Contracting Authority and Project Co and their respective successors and permitted transferees and assigns.

54.10 Governing Law and Jurisdiction

- (a) This Project Agreement, and each of the documents contemplated by or delivered under or in connection with this Project Agreement, shall be governed by and construed in accordance with the laws of Ontario and the laws of Canada applicable therein and shall be treated in all respects as an Ontario contract, without regard to conflict of laws principles.

- (b) Subject to Schedule 27 – Dispute Resolution Procedure, both Parties hereby irrevocably attorn to the exclusive jurisdiction of the courts of the Province of Ontario and all courts competent to hear appeals therefrom.
- (c) Nothing in this Project Agreement affects the rights, protections and immunities of the Crown under the *Proceedings Against the Crown Act* (Ontario).

54.11 Cumulative Remedies

- (a) Except as otherwise set forth in this Project Agreement, the rights, powers and remedies of each Party set forth in this Project Agreement are cumulative and are in addition to and without prejudice to any other right, power or remedy that may be available to such Party under this Project Agreement.

54.12 Further Assurance

- (a) Each Party shall do all things, from time to time, and execute all further documents necessary to give full effect to this Project Agreement.

54.13 Costs

- (a) Each Party shall be responsible for paying its own costs and expenses incurred in connection with the negotiation, preparation and execution and delivery of this Project Agreement.

54.14 Language of Agreement

- (a) Each of the parties acknowledges having requested and being satisfied that this Project Agreement and related documents be drawn in English. Chacune des parties reconnaît avoir demandé que ce document et ses annexes soient rédigés en anglais et s'en déclare satisfaite.
- (b) For greater certainty, all correspondence, Notices, drawings, test reports, certificates, specifications, information, operation and maintenance instructions, name plates, identification labels, instructions and notices to the public and staff and all other written, printed or electronically readable matter required in accordance with, or for purposes envisaged by, this Project Agreement shall be in English.

54.15 Proof of Authority

- (a) Contracting Authority and Project Co each reserve the right to require any person executing this Project Agreement on behalf of the other Party to provide proof, in a form acceptable to Contracting Authority or Project Co, as applicable, that they have the requisite authority to execute this Project Agreement on behalf of and to bind Contracting Authority or Project Co, as applicable.

54.16 Counterparts

- (a) This Project Agreement may be executed in one or more counterparts. Any single counterpart or a set of counterparts executed, in either case, by all the Parties shall constitute a full, original and binding agreement for all purposes. Counterparts may be executed either in original or faxed form

provided that any Party providing its signature in faxed form shall promptly forward to the other Party an original signed copy of this Project Agreement which was so faxed.

54.17 Province Persons and Contracting Authority Parties as Third Party Beneficiaries

- (a) All provisions expressed to be for the benefit of a Province Person or Contracting Authority Party, as applicable, are:
 - (i) intended for the benefit of each Province Person, or Contracting Authority Party, as applicable and, if so set out in the relevant Section, each Province Person's or Contracting Authority Party's, as applicable, directors, officers employees, board appointees, agents and representatives, and shall be enforceable by each of such persons and his or her heirs, executors, administrators and other legal representatives (collectively, in respect of each Province Person, the "**Province Person Third Party Beneficiaries**", and in respect of each Contracting Authority Party, the "**Contracting Authority Third Party Beneficiaries**"); and
 - (ii) are in addition to, and not in substitution for, any other rights that the Province Person Third Party Beneficiaries may have in contract or otherwise.
- (b) Contracting Authority shall hold the rights and benefits of each provision of this Project Agreement which is to the benefit of each Province Person or Contracting Authority Party, as applicable, in trust for and on behalf of the Province Person Third Party Beneficiaries or Contracting Authority Third Party Beneficiaries, as applicable, and Contracting Authority hereby accepts such trust and agree to hold the benefit of and enforce performance of such covenants on behalf of the Province Person Third Party Beneficiaries or Contracting Authority Third Party Beneficiaries, as applicable.

54.18 Time is of the Essence

- (a) Time is of the essence in this Project Agreement.

54.19 Copyright Notice

- (a) The Parties acknowledge that the Queen's Printer for Ontario is the exclusive owner of the copyright in the Project Agreement.

[SIGNATURE PAGES IMMEDIATELY FOLLOW]

IN WITNESS WHEREOF the Parties have executed this Project Agreement as of the date first above written.

ONTARIO INFRASTRUCTURE AND LANDS CORPORATION, a Crown agent, continued under the *Ontario Infrastructure and Lands Corporation Act, 2011*

Per: _____
Name: **[REDACTED]**
Title: **[REDACTED]**

Per: _____
Name:
Title:

I/We have authority to bind the corporation.

METROLINX

Per: _____
Name:
Title:

Per: _____
Name:
Title:

I/We have authority to bind the corporation.

GCRS DAVENPORT GENERAL PARTNERSHIP,
by its partners:

GCP DAVENPORT INC.

Per: _____
Name: **[REDACTED]**
Title: **[REDACTED]**

I have authority to bind the corporation.

GRACORP DAVENPORT INC.

Per: _____
Name: **[REDACTED]**
Title: **[REDACTED]**

I have authority to bind the corporation.

SCHEDULE 1

DEFINITIONS AND INTERPRETATION

1. **Definitions.** In the Project Agreement, unless the context otherwise requires:
 - 1.1 “**Access Management Plan**” has the meaning given in Schedule 10 – Review Procedure.
 - 1.2 “**Access Quality Management Plan**” has the meaning given in Schedule 11 – Quality Management.
 - 1.3 “**Accessibility Requirements**” has the meaning given in Schedule 15 – Output Specifications.
 - 1.4 “**Accident**” means an undesired or unplanned event that results in death, injury or damage to property or process.
 - 1.5 “**Account Trustee**” has the meaning given in Schedule 30 – Insurance Trust Agreement.
 - 1.6 “**Additional Contractor**” means any independent contractor (not being, for the avoidance of doubt, any of the Third Party Contractors or Project Co) or Contracting Authority’s own forces, engaged by Contracting Authority to carry out the Additional Works.
 - 1.7 “**Additional Train Movement**” has the meaning given in Schedule 34 – Rail Corridor Access and Flagging.
 - 1.8 “**Additional Works**” means those works or services, (i) in relation to any of the New Metrolinx Infrastructure or in relation to any New Third Party Infrastructure; or (ii) being carried out on the Site or Existing Metrolinx Infrastructure, which are not Works and which are to be carried out by an Additional Contractor, including works or services to be performed either before or after Substantial Completion.
 - 1.9 “**Adjacent Developments**” means any development works or like activity carried out during the Project Term by or on behalf of any third party adjacent to the Lands, New Metrolinx Infrastructure or New Third Party Infrastructure and which otherwise affects or may potentially affect any part of the Works, the Lands or the New Metrolinx Infrastructure or New Third Party Infrastructure.
 - 1.10 “**Advisory Temporary Signage Plan**” means the plan to be included in Project Co’s Access Management Plan, as provided in Schedule 10 – Review Procedure.
 - 1.11 “**Affiliate**” means an “**affiliate**” as that term is used in the *Business Corporations Act* (Ontario) and any successor legislation thereto, and, in the case of Project Co, shall include each of the unitholders, shareholders, partners or owners of Project Co, as applicable, and any person or entity controlling, controlled by or under common control with Project Co where “control” of any person or entity shall mean the ownership, directly or indirectly, of securities of such person or entity having the power to elect a majority of directors or similar authority or to otherwise control the decisions made on behalf of such person or entity.
 - 1.12 “**Ancillary Documents**” means the Design and Construction Contract [REDACTED].

- 1.13 “**Anticipated Final Completion Date**” has the meaning given in Section 25.12(a) of the Project Agreement.
- 1.14 “**Anticipated Milestone Payment Completion Date**” has the meaning given in Section 25A.1(a) of the Project Agreement.
- 1.15 “**Anticipated Substantial Completion Date**” has the meaning given in Section 25.8(a) of the Project Agreement.
- 1.16 “**Applicable Law**” means:
- (a) any statute or proclamation or any delegated or subordinate legislation including regulations and by-laws;
 - (b) any Authority Requirement; and
 - (c) any judgment of a relevant court of law, board, arbitrator or administrative agency which is a binding precedent in the Province of Ontario,
- in each case, in force in the Province of Ontario, or otherwise binding on Project Co, any Project Co Party, Contracting Authority, any Contracting Authority Party or any Province Person.
- 1.17 “**Appointed Representative**” has the meaning given in Schedule 4 – Lenders’ Direct Agreement.
- 1.18 “**Appointed Representative Notice**” has the meaning given in Schedule 4 – Lenders’ Direct Agreement.
- 1.19 “**Apprenticeship Plan**” has the meaning given in Section 11.23(a) of the Project Agreement.
- 1.20 “**Arborist Report Reassessment Addendum**” has the meaning given in Schedule 17 – Environmental Obligations.
- 1.21 “**Archaeological Report**” has the meaning [REDACTED].
- 1.22 “**Artist**” has the meaning given in Schedule 15 – Output Specifications.
- 1.23 “**As Built Drawings**” means drawings prepared by Project Co in a format and with content and details that Contracting Authority, acting reasonably, considers appropriate.
- 1.24 “**Associated Liabilities**” has the meaning given in Section 4.20(b) of the Project Agreement.
- 1.25 “**Authority Requirements**” means any order, direction, directive, request for information, policy, administrative interpretation, guideline or rule of or by any Governmental Authority and includes, for clarity, any direction or instruction from Transport Canada arising from any contractual arrangement or board orders involving Transport Canada and one or both of MTO or Metrolinx with respect to the Rail Corridor.
- 1.26 “**Background Information**” means any and all drawings, reports (including the Environmental Reports, the Archaeological Reports, the Geotechnical Reports, the Cultural Heritage Reports and

the Environmental Assessments, the Subsurface Utility Engineering (SUE) Report and any other report given or otherwise referred to in the Output Specifications), studies, plans, data, documents, or other information, given or made available to Project Co or any Project Co Party by Contracting Authority or any Contracting Authority Party, or which was obtained from or through any other sources prior to the date of the Project Agreement.

- 1.27 “**Bank**” has the meaning given in Schedule 30 – Insurance Trust Agreement.
- 1.28 “**Bankruptcy and Insolvency Act (Canada)**” means the *Bankruptcy and Insolvency Act*, R.S.C. 1985, c. B-3, as amended from time to time.
- 1.29 “**Baseline Works Schedule**” has the meaning given in Schedule 12 – Works Schedule Requirements.
- 1.30 “**Basis of Works Schedule Report**” has the meaning given in Schedule 12 – Works Schedule Requirements.
- 1.31 “**Beneficiary**” has the meaning given in Section 46.3(a) of the Project Agreement.
- 1.32 “**Bond**” means any one or more of the Performance Bond and the Labour and Material Payment Bond described in Section 17 of Schedule 25 – Insurance and Performance Security Requirements, and, collectively, “**Bonds**” means all of them.
- 1.33 “**Business Corporations Act (Ontario)**” means the *Business Corporations Act*, R.S.O. 1990, c. B.16, as amended from time to time.
- 1.34 “**Business Day**” means any day other than a Saturday, a Sunday, a statutory holiday in the Province of Ontario or any day on which banks are not open for business in the City of Toronto, Ontario.
- 1.35 “**Canadian and Industry Standards**” means, at the applicable time, those standards, practices, methods and procedures applicable to Good Industry Practice.
- 1.36 “**Canadian GAAP**” shall be deemed to be the generally accepted accounting principles from time to time approved by the Canadian Institute of Chartered Accountants, or any successor institute, applicable as at the date on which such calculation is made or required to be made in accordance with generally accepted accounting principles, as such principles may be amended or varied by International Financial Reporting Standards then in effect in Canada, in any case consistently applied from one period to the next.
- 1.37 “**Canadian Railway Operating Rules**” has the meaning given in Schedule 34 – Rail Corridor Access and Flagging.
- 1.38 “**Capital Expenditure**” means capital expenditure as interpreted in accordance with Canadian GAAP.
- 1.39 “**Category 1 Utility Company**” means any one of,
- (a) Bell Canada;

- (b) Enbridge Gas Distribution Inc.;
- (c) Toronto-Hydro Electric System Limited;
- (d) Roger Communications Partnership;
- (e) Bell 360; and
- (f) Toronto Transit Commission (“**TTC**”),

to the extent that such Utility Companies are performing Category 1 Utility Work.

- 1.40 “**Category 1 Utility Work**” means the Utility Work that the Category 1 Utility Company must carry out itself (by the Category 1 Utility Company’s own forces or by a subcontractor retained by the Category 1 Utility Company) pursuant to the Final Utility Baseline Document.
- 1.41 “**Category 2 Utility Company**” means any Utility Company that is not defined as a Category 1 Utility Company.
- 1.42 “**Certificate of Recognition**” means the certification issued by IHSA to a person confirming that the health and safety management systems of such person comply with the terms, provisions and conditions of the COR Program.
- 1.43 “**Certification Services**” has the meaning given in Schedule 6 – Independent Certifier Agreement.
- 1.44 “**Certification Services Variation**” has the meaning given in Schedule 6 – Independent Certifier Agreement.
- 1.45 “**Certified H&S Inspector**” means an individual who is an employee or contractor of the IHSA and has the necessary credentials recognized by the COR Program for the purpose of such individual performing any inspections as may be required to be performed in accordance with Section 15.1(b) of the Project Agreement.
- 1.46 “**Change in Control**” means, with respect to a person:
- (a) any Change in Ownership, where the effect of such change is to result in control of the decisions made by or on behalf of such person subsequently being with a different entity or entities than prior to such change;
 - (b) any other change in respect of the power to elect a majority of the directors of the person or otherwise control the decisions made on behalf of such person; or
 - (c) any other change of direct or indirect power or authority through any contractual right or other power or interest with or over a person to influence, direct, cause to change or prevent from changing the approval of a decision, direction of the management, actions or policies of such person, to direct or cause the direction of the management, actions or policies of such person.

- 1.47 “**Change in Law**” means the coming into effect or repeal (without re-enactment or consolidation) in Ontario of any Applicable Law, or any amendment or variation of any Applicable Law, including any judgment of a relevant court of law which changes binding precedent in Ontario in each case after the date of the Project Agreement.
- 1.48 “**Change in Ownership**” means, with respect to a person, any change in ownership, whether beneficial or otherwise, of any of the shares or units of ownership of such person, or in the direct or indirect power to vote or transfer any of the shares or units of ownership of such person.
- 1.49 “**Changed Cost for Utilities**” means an amount equal to,
- (a) the total aggregate price actually paid by Project Co for the Eligible Utilities Costs minus any Ineligible Cost Increase; minus,
 - (b) the Original Eligible Utilities Cost.
- 1.50 “**City of Toronto**” means the City of Toronto and all operating divisions thereof.
- 1.51 “**City of Toronto Act (Ontario)**” means the *City of Toronto Act (Ontario)*, 2006, S.O. 2006, C. 11, Sched. A, as amended from time to time.
- 1.52 “**City PLAA Deadline**” has the meaning given in Section 11.8(e) of the Project Agreement.
- 1.53 “**CMMS**” has the meaning given in Schedule 15 – Output Specifications.
- 1.54 “**CN**” means the Canadian National Railway Company and any successors thereto.
- 1.55 “**Commercial Close**” means the date of the Project Agreement.
- 1.56 “**Commissioning Submittals**” has the meaning given in Schedule 14 – Outline Commissioning Program and Handover.
- 1.57 “**Commissioning Team**” has the meaning given in Schedule 14 – Outline Commissioning Program and Handover.
- 1.58 “**Commissioning Tests**” means all commissioning tests:
- (a) described in Schedule 14 – Outline Commissioning Program and Handover;
 - (b) required by Applicable Law, Canadian and Industry Standards or CSA Standards;
 - (c) recommended by the manufacturer of any part of the New Metrolinx Infrastructure or the New Third Party Infrastructure;
 - (d) required to be included in the Interim Completion Commissioning Program by the Independent Certifier, the Contracting Authority Commissioning Consultant or the Contracting Authority Representative during its development pursuant to Section 24.2 of the Project Agreement; and

- (e) required to be included in the Final Commissioning Program by the Independent Certifier, the Contracting Authority Commissioning Consultant or the Contracting Authority Representative during its development pursuant to Section 25.2 of the Project Agreement.
- 1.59 “**Communications Plan**” means the plan to be included in Project Co’s Access Management Plan as required in Schedule 10 – Review Procedure.
- 1.60 “**Community Engagement and Stakeholder Relations Plans**” has the meaning given in Schedule 18 – Communication and Public Engagement Protocol.
- 1.61 “**Companies’ Creditors Arrangement Act (Canada)**” means the *Companies’ Creditors Arrangement Act*, R.S.C. 1985, c. C-36, as amended from time to time.
- 1.62 “**Compensation Event**” has the meaning given in Section 33.1(a) of the Project Agreement.
- 1.63 “**Compensation Payment**” means the Contracting Authority Default Termination Sum, the Project Co Default Termination Sum or the Non-Default Termination Sum.
- 1.64 “**Completion Holdback**” has the meaning given in Section 25.9(a) of the Project Agreement.
- 1.65 “**Confidant**” has the meaning given in Section 42.6(a)(i) of the Project Agreement.
- 1.66 “**Confidential Information**” means all confidential and proprietary information which is supplied by or on behalf of a Party, whether before or after the date of the Project Agreement.
- 1.67 “**Construction Act**” means the *Construction Act*, R.S.O. 1990, c.C.30, and regulations enacted thereunder, all as amended from time to time and subject to the application of the transition provisions in s. 87.3 of the Construction Act.
- 1.68 “**Construction Activities**” means construction, rehabilitation, Reinstatement Work, rectification work, Warranty Work, and any other aspect of the Works that:
- (a) comprises the alteration, augmenting, upgrading, construction, completion, inspection, calibration, testing or commissioning of any part of the New Metrolinx Infrastructure and the New Third Party Infrastructure;
 - (b) comprises the assessment of any New Metrolinx Infrastructure or New Third Party Infrastructure;
 - (c) may affect the structural integrity of any New Metrolinx Infrastructure or New Third Party Infrastructure, and including any such aspect of the Works carried out as part of any Force Majeure event, Relief Event, Variation, or Innovation Proposal accepted by Contracting Authority; or
 - (d) comprises Construction Clearing and Grubbing.
- 1.69 “**Construction Certificate**” means a certificate with contents described in Attachment 2 to Appendix A of Schedule 10 – Review Procedure.

- 1.70 “**Construction Clearing and Grubbing**” means the stage of the Works in which vegetation and debris is cleared from the Lands (clearing) and a root rake or similar device is employed to remove roots remaining in the soil (grubbing).
- 1.71 “**Construction Contractor**” means [REDACTED], engaged by Project Co to perform the Works and any substitute construction contractor engaged by Project Co as may be permitted by the Project Agreement.
- 1.72 “**Construction Contractor’s Direct Agreement**” means the direct agreement between Contracting Authority, Project Co, the Construction Contractor and the Construction Guarantor in the form set out in Schedule 5 – Construction Contractor’s Direct Agreement.
- 1.73 “**Construction Defect**” has the meaning given to it in Section 11.15(a)(i) of the Project Agreement.
- 1.74 “**Construction Document Submittals**” has the meaning given in Section 11.1(d)(ii) of the Project Agreement.
- 1.75 “**Construction Guarantor**” means [REDACTED].
- 1.76 “**Construction Latent Defect**” has the meaning given in Section 11.16(b)(ii) of the Project Agreement.
- 1.77 “**Construction Management Plan**” has the meaning given in Schedule 10 – Review Procedure.
- 1.78 “**Construction Period Quality Failure**” has the meaning given in Schedule 21 – Liquidated Damages and Construction Enforcement Regime.
- 1.79 “**Construction Quality Management Plan**” has the meaning given in Schedule 11 – Quality Management.
- 1.80 “**Construction Safety Manager**” means the person appointed by Project Co to implement the Construction Safety Plan.
- 1.81 “**Construction Safety Plan**” or “**CSP**” means a plan, prepared by Project Co, that demonstrates how Project Co will meet all of its safety obligations under the *Occupational Health and Safety Act* (Ontario), Transport Canada, GO Transit safety requirements and CN Rail safety requirements.
- 1.82 “**Contamination**” means the presence of any Hazardous Substance in the environment, except Hazardous Substances present in the environment in concentrations below applicable standards as set by Applicable Laws. If Contamination is present in soil, surface water or groundwater, then the soil, surface water or groundwater, as applicable, containing the Contamination shall also be deemed to be Contamination for the purposes of the Project Agreement.
- 1.83 “**Contracting Authority**” means, collectively, (i) IO and (ii) Metrolinx.
- 1.84 “**Contracting Authority Activities**” means the provision of all governmental services and the conduct of all activities provided in connection or otherwise associated with rail transit and other similar services.

- 1.85 “**Contracting Authority Commissioning**” means the commissioning activities that may be carried out by Contracting Authority in accordance with the Final Commissioning Program.
- 1.86 “**Contracting Authority Commissioning Consultant**” means the person appointed by Contracting Authority as its commissioning consultant.
- 1.87 “**Contracting Authority Commissioning Period**” means the period during which Contracting Authority is performing the Contracting Authority Commissioning.
- 1.88 “**Contracting Authority Commissioning Tests**” means all commissioning tests required to be performed by Contracting Authority pursuant to the Final Commissioning Program.
- 1.89 “**Contracting Authority Default Termination Sum**” has the meaning given in Schedule 23 – Compensation on Termination.
- 1.90 “**Contracting Authority Design Team**” means any of Contracting Authority, its agents, contractors and subcontractors of any tier and its or their directors, officers and employees, and other persons engaged in respect of design reviews, design evaluation, or design consultation processes with respect to the New Metrolinx Infrastructure or the New Third Party Infrastructure or the Contracting Authority Activities, but excluding Project Co and any Project Co Party.
- 1.91 “**Contracting Authority Event of Default**” has the meaning given in Section 37.1(a) of the Project Agreement.
- 1.92 “**Contracting Authority HR Policy**” means Contracting Authority’s human resources policies and guidelines, as they may be amended from time to time and provided to Project Co in writing.
- 1.93 “**Contracting Authority Jointly Developed Materials**” has the meaning given in Section 41.4(a)(i) of the Project Agreement.
- 1.94 “**Contracting Authority Party**” means any of Contracting Authority and its respective agents, contractors and subcontractors of any tier and its or their directors, officers and employees, and other persons engaged by any of the foregoing in respect of the Contracting Authority Activities, but excluding Project Co and any Project Co Party, and the “Contracting Authority Parties” shall be construed accordingly.
- 1.95 “**Contracting Authority Permits, Licences, Approvals and Agreements**” means only those Contracting Authority permits, licences, approvals and agreements which are the responsibility of Contracting Authority to obtain as set out in Appendix A to this Schedule 1 – Permits, Licences, Approvals and Agreements, but for greater certainty shall not include any permission, consent, approval, certificate, permit, licence, agreement or authorization not set out in Appendix A to this Schedule 1 – Permits, Licences, Approvals and Agreements but required by the terms of any such item set out in such Appendix.
- 1.96 “**Contracting Authority Representative**” means the person designated as such by Contracting Authority on or prior to the date of the Project Agreement and any permitted replacement.
- 1.97 “**Contracting Authority Supplied Third Party Intellectual Property**” has the meaning given in Schedule 24 – Intellectual Property.

- 1.98 “**Contracting Authority Taxes**” means taxes, or payments in lieu of taxes, imposed on Contracting Authority and HST and property taxes for which Contracting Authority is responsible pursuant to Section 4.14 of the Project Agreement.
- 1.99 “**Contracting Authority Third Party Beneficiaries**” has the meaning given in Section 54.17(a)(i) of the Project Agreement.
- 1.100 “**Contracting Authority Trade-Marks**” means any and all Trade-Marks used by Contracting Authority in any manner whatsoever.
- 1.101 “**Contractor Site Specific Safety Manual**” means the document describing the Construction Contractor’s health and safety management program for the Project and the Site commencing no later than the first Business Day following Financial Close until Final Completion, all in accordance with the minimum requirements set out in Schedule 35 – Contractor Site Specific Safety Manual Requirements.
- 1.102 “**Control Party**” means:
- (a) any person with any form of direct ownership interest in Project Co;
 - (b) [REDACTED]; and
 - (c) [REDACTED].
- 1.103 “**Co-ordination Study Report**” means a study determining overcurrent protection equipment throughout the power distribution system so the minimum amount of power service to equipment is interrupted as a result of a fault, current overload or disconnection occurring anywhere in the power distribution system.
- 1.104 “**Copyrights**” means all copyrights (registered or otherwise) and registrations and applications for registration thereof, and all rights therein provided by multinational treaties or conventions.
- 1.105 “**COR Certification**” means, in respect of a person, receipt by such person of its (i) Certificate of Recognition; and (ii) Letter of Good Standing.
- 1.106 “**COR Program**” means the national safety program known as “The Certificate of Recognition (COR™)”, being a safety program that enables persons to assess their health and safety management systems to manage risks, establish controls, and minimize the incidence of injury and illness to their workers, and being nationally trademarked and endorsed by participating members of the Canadian Federation of Construction Safety Associations, or such other national safety program approved by Contracting Authority.
- 1.107 “**COR-Certified Construction Project Co Party**” has the meaning given in Section 11.25(a)(ii) of the Project Agreement.
- 1.108 “**COR-Qualified Construction Project Co Party**” means one of the following:
- (a) where the Construction Contractor is a single legal entity, the Construction Contractor;

- (b) where the Construction Contractor is a joint venture, each member of the joint venture; or
- (c) where the Construction Contractor is a partnership, each partner of the partnership,
- provided that each such person has current OHSAS 18001 Accreditation in good standing.
- 1.109 “**Cost Adjustment – Utilities**” has the meaning given in Section 4.21(a) of the Project Agreement.
- 1.110 “**Cost of the Financing**” means all costs and expenses incurred in connection with the Financing pursuant to the Lending Agreements, including all interest, fees, expense reimbursements, pre-payment and breakage costs and all other costs and expenses, as set out in Schedule 32 – Financial Model.
- 1.111 “**Cost of the Works**” means the cost to Project Co of performing the Works as set out in Schedule 32 – Financial Model and shall include all amounts to be included in the Cost of the Works set out in the Project Agreement.
- 1.112 “**Countdown Notice**” has the meaning given in Section 25.8(a) of the Project Agreement.
- 1.113 “**CP**” means Canadian Pacific Railway Company and any successors thereto.
- 1.114 “**CPI**” means, as at the date of the Project Agreement, CPI XFET and, thereafter, the latest available Consumer Price Index Canada (all items) as published by Statistics Canada from time to time (whether preliminary or final), or failing such publication, such other index as the Parties may agree, or as may be determined in accordance with Schedule 27 – Dispute Resolution Procedure, most closely resembles such index.
- 1.115 “**CPI XFET**” means the Consumer Price Index excluding food, energy and the effect of changes in indirect taxes.
- 1.116 “**CPI_{In}**” is the value of CPI on April 1 of the relevant year, to be determined by reference to the relevant index in the month of February most recently preceding the indexation date.
- 1.117 “**CPI_o**” is the value of CPI at Financial Close, to be determined by reference to the relevant index in the month immediately preceding Financial Close.
- 1.118 “**Critical Non-Conformance**” means any Non-Conformance, or combination of Major Non-Conformances, that:
- (a) in the reasonable opinion of Contracting Authority, demonstrates that Project Co is performing the Works in a manner that may result in Project Co becoming unable to satisfy the requirements for Interim Completion or Substantial Completion;
- (b) is persistent, ongoing and repeated; or

- (c) in the reasonable opinion of Contracting Authority, by its continued existence or through the process of rectification, would:
 - (i) result or is reasonably expected to result in material disruption to the public or a materially adverse disruption to traffic flow or the public transit system in the Municipality;
 - (ii) prejudice or is reasonably expected to materially prejudice the performance of any Governmental Activities;
 - (iii) create or is reasonably expected to create a serious threat to the health, safety or security of any person, including any user of any part of or the whole of the New Metrolinx Infrastructure, New Third Party Infrastructure and/or Existing Infrastructure, including System Users, volunteers and visitors to the New Metrolinx Infrastructure, New Third Party Infrastructure and/or Existing Infrastructure, and members of the public;
 - (iv) materially increase Contracting Authority’s risk or transfer risk to Contracting Authority or any Contracting Authority Party;
 - (v) materially adversely affect the ability of any Contracting Authority Party, Other Contractor or the Operator to perform their activities as permitted or contemplated by the Project Agreement;
 - (vi) materially adversely affect or change the critical path of the Project as defined in the Progress Works Schedule, adversely affect Project Co’s ability to achieve Interim Completion by the Scheduled Interim Completion Date or Substantial Completion by the Scheduled Substantial Completion Date, require a material resequencing of the Works or cause any delay in achieving Interim Completion or Substantial Completion; or
 - (vii) potentially compromise,
 - (A) the reputation or integrity of Contracting Authority and/or any Contracting Authority Party; or
 - (B) the nature of the public transit system in the Municipality or the Province of Ontario so as to affect public confidence in the public transit system in the Municipality, the Province of Ontario or the Project.

1.119 “**Crown**” means Her Majesty the Queen in right of Ontario.

1.120 “**Crown Agency Act (Ontario)**” means the *Crown Agency Act*, R.S.O. 1990, c. 48, as amended from time to time.

1.121 “**CSA Standards**” means, at the applicable time, the Canadian Standards Association standards.

1.122 “**Cultural Heritage Report**” has the meaning [REDACTED].

- 1.123 “**Delay Event**” has the meaning given in Section 32.1(a) of the Project Agreement.
- 1.124 “**Demolition**” means the removal of a building or structure, as the case may be, or of any material part of a building or structure.
- 1.125 “**Demolition Default Event**” has the meaning given in Section 11.26(b) of the Project Agreement.
- 1.126 “**Demolition Guidelines**” means those guidelines set forth in the document entitled “Professional Engineers Providing Services for Demolition of Buildings and other Structures” published by the Professional Standards Committee established by the Professional Engineers of Ontario and having a publication date of April, 2011.
- 1.127 “**Demolition Plan**” means a plan or other document prepared by a professional engineer, limited licence holder or provisional licence holder in accordance with subsection (3) of the Performance Standards Regulation with respect to the Demolition of a building or structure, and includes any changes to the plan or other document that are made by a professional engineer, limited licence holder or provisional licence holder.
- 1.128 “**Demolition Requirements**” has the meaning given in Section 11.26(a) of the Project Agreement.
- 1.129 “**Demolition Specifications**” means those specifications relating to any Demolition prepared by Project Co in accordance with Section 11.26(a)(iv)(A) of the Project Agreement.
- 1.130 “**Demolition Supervisor**” has the meaning given in Section 11.26(a)(ii) of the Project Agreement.
- 1.131 “**Design and Bid Fee**” has the meaning given in the Request for Proposals.
- 1.132 “**Design and Construction Certification Procedure**” has the meaning given in Schedule 11 – Quality Management.
- 1.133 “**Design and Construction Contract**” means the design and construction contract between Project Co and the Construction Contractor dated on or about the date of Financial Close.
- 1.134 “**Design Brief**” means a narrative document to accompany the Works Submittals with contents as described in Appendix A to Schedule 10 – Review Procedure.
- 1.135 “**Design Certificate**” means a certificate with contents described in Attachment 1 to Schedule 10 – Review Procedure.
- 1.136 “**Design Compliance Consultant**” means [REDACTED].
- 1.137 “**Design Data**” means all drawings, reports, documents, plans, software, formulae, calculations, and other data prepared or obtained by Project Co relating to the design, construction, testing or monitoring of the New Metrolinx Infrastructure and the New Third Party Infrastructure, but excluding Intellectual Property Rights of third parties, such as CAD software, that is used only in the process of design and construction.
- 1.138 “**Design Development Submittal**” has the meaning given in Section 11.1(d)(i) of the Project Agreement.

- 1.139 “**Design Quality Management Plan**” has the meaning given in Schedule 11 – Quality Management.
- 1.140 “**Design Requirements Manual**” or “**DRM**” means the document created by Metrolinx that outlines the guiding principles and technical details for the infrastructure requirements to design and build GO stations, terminals, and facilities. All references to DRM also include the GO standard drawings, specifications, guidelines, GO Transit Track Standards and other materials available on the Metrolinx website: http://www.gosite.ca/engineering_public/
- 1.141 “**Design Team**” means:
- (a) [REDACTED];
 - (b) [REDACTED];
 - (c) [REDACTED]; and
 - (d) [REDACTED],
- each engaged by Project Co to design the New Metrolinx Infrastructure and the New Third Party Infrastructure and any substitute design team engaged by Project Co as may be permitted by the Project Agreement.
- 1.142 “**Design Workshops**” has the meaning given in Section 11.3(a) of the Project Agreement.
- 1.143 “**Detailed Construction Activity Report**” has the meaning given in Schedule 10 – Review Procedure.
- 1.144 “**Development Approvals**” means development permits, building permits, zoning approvals and any other planning or development permit, consent or applicable Permits, Licences, Approvals and Agreements, required from time to time for construction of the New Metrolinx Infrastructure and the New Third Party Infrastructure.
- 1.145 “**Direct Cost**” has the meaning given in Schedule 22 – Variation Procedure.
- 1.146 “**Direct Fixation Fastening System**” or “**Direct Fixation**” has the meaning given in Schedule 15 – Output Specifications.
- 1.147 “**Direct Losses**” means all damage, losses, liabilities, penalties, fines, assessments, claims, actions, costs, expenses (including the cost of legal or professional services, legal costs being on a substantial indemnity basis), proceedings, demands and charges whether arising under statute, contract or at common law, except Indirect Losses.
- 1.148 “**Direct or Indirect Power or Control**” means the direct or indirect power or control over the decisions, management, actions or policies of a person, including through the direct or indirect power or control over the decisions, management, actions or policies of any persons having direct or indirect power or control over the decisions, management, actions or policies of any other person, whether through:

- (a) ownership, beneficial or otherwise, of greater than [REDACTED] percent of any of the shares, units or equity interests of a person;
- (b) the direct or indirect power to vote any of the shares, units or equity interests of a person where an individual's ownership, beneficial or otherwise, is equal to or exceeds [REDACTED] percent of the voting securities, units or equity interests of such person; or
- (c) the direct or indirect power or authority to influence or direct the approval of a decision, the management, actions or policies of a person or to prevent the approval of a decision, the management, actions or policies of a person through any contractual right or other power or interest with or over a person.

1.149 **“Discriminatory Change in Law”** means any Change in Law which apply expressly to:

- (a) transit systems, including rail transit systems whose design, construction, and financing are procured by a contract similar to the Project Agreement and not to other similar transit systems;
- (b) the New Metrolinx Infrastructure or New Third Party Infrastructure and not to other transit systems, including rail transit systems;
- (c) Project Co and not to other persons; or
- (d) persons undertaking projects for design, construction, and financing that are procured by a contract similar to the Project Agreement and not to other persons undertaking similar projects procured on a different basis,

except that such Change in Law shall not be a Discriminatory Change in Law:

- (e) where it is in response to any act or omission on the part of Project Co which contravenes Applicable Law (other than an act or omission rendered illegal by virtue of the Discriminatory Change in Law itself);
- (f) solely on the basis that its effect on Project Co is greater than its effect on other companies; or
- (g) where such Change in Law affects companies generally.

1.150 **“Dispute”** has the meaning given in Schedule 27 – Dispute Resolution Procedure.

1.151 **“Dispute Resolution Procedure”** means the procedure set out in Schedule 27 – Dispute Resolution Procedure.

1.152 **“Diversion Track”** has the meaning given in Schedule 15 – Output Specifications.

1.153 **“Economic Interest”** means any right to receive, directly or indirectly and whether in cash or in kind, a payment, repayment, fee, interest, dividend, distribution, redemption or any other consideration of benefit or value to the recipient of any nature whatsoever, but excluding wages, salaries or other employment-related benefits.

- 1.154 “**Egress Stairs**” has the meaning given in Schedule 15 – Output Specifications.
- 1.155 “**Eligible Utilities Costs**” means the price charged to Project Co by the Category 1 Utility Companies to perform the Category 1 Utility Work.
- 1.156 “**Embargo Period**” means the dates when Utility Companies do not permit works to be undertaken.
- 1.157 “**Emergency**” means any situation, event, occurrence, multiple occurrences or circumstances:
- (a) that:
 - (i) constitutes or may constitute a hazard to or jeopardizes or may jeopardize or pose a threat to health and safety of any persons (including System Users and Province Persons) or any part of or the whole of the New Metrolinx Infrastructure, the New Third Party Infrastructure or the Existing Infrastructure;
 - (ii) causes or may cause damage or harm to property, buildings and/or equipment;
 - (iii) constitutes a hostage situation or state of emergency declared as such by the Contracting Authority Representative or Contracting Authority (acting reasonably);
 - (iv) materially interferes with or prejudices or may materially interfere with or prejudice the safe operation of the New Metrolinx Infrastructure or New Third Party Infrastructure, any part of the Lands, the conduct of Works, or the conduct of Governmental Activities; or
 - (v) constitutes a period of transition to or from war,and which, in the opinion of Contracting Authority, requires immediate action to prevent and/or mitigate the occurrence (or risk of the occurrence) of the foregoing; or
 - (b) which gives rise to an emergency, as determined by any statutory body including (notwithstanding the generality of the foregoing) an Emergency Service Provider.
- 1.158 “**Emergency Rail Situation**” has the meaning given in Schedule 34 – Rail Corridor Access and Flagging.
- 1.159 “**Emergency Response Plan**” means the written plan describing strategies for all aspects of emergency response, communication with first responders, coordination with the community, information dissemination, recovery from major incidents, prerequisite employee training, standard operating procedures (SOPs), and the names and contact numbers of the work-site emergency management supervisor and other designated individuals.
- 1.160 “**Emergency Service Providers**” means any Police Service, firefighting service, ambulance service, armed forces or other authority with emergency service authority pursuant to Applicable Law which may require access to the New Metrolinx Infrastructure or New Third Party Infrastructure from time to time.

- 1.161 “**Encumbrances**” means the Encumbrances listed in Schedule 16 - Encumbrances and any other encumbrances deemed to be Encumbrances as described in and for the purposes set out in Section 17.2(d) of the Project Agreement.
- 1.162 “**Environmental Activity and Sector Registry**” or “**EASR**” has the meaning given in Schedule 17.
- 1.163 “**Environmental Approval**” has the meaning given in Schedule 17 – Environmental Obligations.
- 1.164 “**Environmental Assessments**” has the meaning given in Schedule 17 – Environmental Obligations.
- 1.165 “**Environmental Director**” has the meaning given in Schedule 17 – Environmental Obligations.
- 1.166 “**Environmental Law**” has the meaning given in Schedule 17 – Environmental Obligations.
- 1.167 “**Environmental Management System**” or “**EMS**” has the meaning given in Schedule 17 – Environmental Obligations.
- 1.168 “**Environmental Protection Act (Ontario)**” means the *Environmental Protection Act*, R.S.O. 1990, c. E. 19, as amended from time to time.
- 1.169 “**Environmental Quality Management Plan**” means has the meaning given in Schedule 11 – Quality Management.
- 1.170 “**Environmental Reports**” means, [REDACTED]:
- (a) [REDACTED];
 - (b) [REDACTED]; and
 - (c) [REDACTED].
- 1.171 “**Estimate**” has the meaning given in Schedule 22 – Variation Procedure.
- 1.172 “**Excise Tax Act (Canada)**” means the *Excise Tax Act*, R.S.C. 1985, c. E-15, as amended from time to time.
- 1.173 “**Executive Council Act (Ontario)**” means the *Executive Council Act*, R.S.O. 1990, c. E. 25, as amended from time to time.
- 1.174 “**Existing Dupont Street Rail Bridge**” has the meaning given in Schedule 15 – Output Specifications.
- 1.175 “**Existing Infrastructure**” means the Existing Metrolinx Infrastructure and the Existing Third Party Infrastructure.
- 1.176 “**Existing Metrolinx Infrastructure**” means the existing assets, systems and services, including public spaces, roads, highways, railway tracks, subways, utilities, bus shelters, platforms, signals,

- signage, parking loads, access roads, electrical, mechanical and communication systems located on the Metrolinx Lands that are owned by Metrolinx.
- 1.177 “**Existing Paton Road Pedestrian Tunnel**” has the meaning given in Schedule 15 – Output Specifications.
- 1.178 “**Executive Project Meeting**” has the meaning given in Section 20.7(a) of the Project Agreement.
- 1.179 “**Executive Project Meeting Document**” has the meaning given in Section 20.7(e) of the Project Agreement.
- 1.180 “**Existing Third Party Infrastructure**” means the existing assets, systems and services, including public spaces, roads, highways, railway tracks, subways, utilities, bus shelters, platforms, signals, signage, parking loads, access roads, electrical, mechanical and communication systems or any other infrastructure situated on the Lands, owned by the MTO, the Municipality, Utilities Companies, Railway Companies, or any other third party.
- 1.181 “**Expiry Date**” means the first anniversary of the Final Completion Date.
- 1.182 “**External Quality Audit**” has the meaning given in Schedule 11 – Quality Management.
- 1.183 “**Final Commissioning Program**” means the program to be jointly developed and agreed by Contracting Authority and Project Co in accordance with Section 25.2 of the Project Agreement.
- 1.184 “**Final Completion**” means the completion of the Works in accordance with the Project Agreement, including completion of all Minor Deficiencies.
- 1.185 “**Final Completion Certificate**” means the certificate to be issued by the Independent Certifier in accordance with Section 25.13 of the Project Agreement.
- 1.186 “**Final Completion Countdown Notice**” has the meaning given in Section 25.12(a) of the Project Agreement.
- 1.187 “**Final Completion Date**” means the date on which Final Completion is achieved as evidenced by the Final Completion Certificate, as such date shall be stated therein.
- 1.188 “**Final Completion Notice**” has the meaning given in Section 25.13(b) of the Project Agreement.
- 1.189 “**Final Utility Baseline Document**” means the Utility Baseline Document attached as Appendix B to this Schedule 1.
- 1.190 “**Financial Administration Act (Ontario)**” means the *Financial Administration Act*, R.S.O. 1990, c. F.12, as amended from time to time.
- 1.191 “**Financial Close**” means the first date that funding is available under the Lending Agreements.

- 1.192 “**Financial Close Target Date**” means July 25, 2019, as such date may be extended in accordance with the provisions of the Project Agreement.
- 1.193 “**Financial Model**” means the computer spreadsheet model included in Schedule 32 – Financial Model for the Project incorporating statements of Project Co’s cashflows including all expenditure, revenues, financing and taxation of the Works together with, if applicable, the profit and loss accounts and balance sheets for Project Co throughout the Project Term accompanied by details of all assumptions, calculations and methodology used in their compilation and any other documentation necessary or desirable to operate the model.
- 1.194 “**Financial Obligations**” means the obligation to pay any application fees, third party fees, costs or charges (including all applicable Taxes thereon), the provision of any letters of credit, instruments of guarantee, bonds or security deposits, or any other financial security obligations.
- 1.195 “**Financing**” means the financing with the Lenders, that is consistent in all material respects with Schedule 32 – Financial Model and the Project Agreement, to finance the Project.
- 1.196 “**Finishing Holdback**” means the finishing construction lien holdback to be retained pursuant to section 22(2) of the Construction Act.
- 1.197 “**Finishing Holdback Payment Date**” means the date for payment of the Finishing Holdback pursuant to Section 4.6(d) of the Project Agreement.
- 1.198 “**FIPPA**” means the *Freedom of Information and Protection of Privacy Act* (Ontario), R.S.O. 1990, c. F.31, as amended from time to time.
- 1.199 “**Fire Safety Plan**” has the meaning given in Schedule 10 – Review Procedure.
- 1.200 “**First Milestone Payment**” means \$31,663,560.41.
- 1.201 “**First Milestone Payment Completion Date**” has the meaning given in Section 25A.2(d)(i) of the Project Agreement.
- 1.202 “**Fisheries Act (Canada)**” means the *Fisheries Act*, R.S.C. 1985, c. F-14, as amended from time to time.
- 1.203 “**Force Majeure**” has the meaning given in Section 35.1(a) of the Project Agreement.
- 1.204 “**Funeral, Burial and Cremations Services Act (Ontario)**” means the Funeral, Burial and Cremations Services Act, S.O. 2002, c.33, as amended from time to time.
- 1.205 “**Geotechnical Reports**” means [REDACTED]:
- (a) [REDACTED];
 - (b) [REDACTED]; and
 - (c) [REDACTED].

- 1.206 “**GO Passenger Charter**” means the GO Transit passenger charter set out on GO Transit’s website (http://www.gotransit.com/passengercharter/en/passenger_charter.aspx), as amended from time to time.
- 1.207 “**GO Transit**” means [REDACTED].
- 1.208 “**GO Transit Design Requirements Manual**” or “**DRM**” has the meaning given in Schedule 15 – Output Specifications.
- 1.209 “**GO Transit Track Standards**” has the meaning given in Schedule 15 – Output Specifications.
- 1.210 “**Good Industry Practice**” means using standards, practices, methods and procedures to a good commercial and rail safety standard, conforming to Applicable Law and exercising that degree of skill and care, diligence, prudence and foresight which would reasonably and ordinarily be expected from a qualified, skilled and experienced person engaged in a similar type of undertaking under the same or similar circumstances.
- 1.211 “**Government Entity**” means any one or more of the Province and MOI.
- 1.212 “**Government Sensitive Information**” means any information which is designated as such by Contracting Authority from time to time, or which a reasonable person having regard to the circumstances, would regard as sensitive, including (i) all confidential information that is designated as such by Applicable Law, and (ii) any record, the disclosure of which could be injurious to the interests of Contracting Authority.
- 1.213 “**Governmental Activities**” means the provision of all governmental services and the conduct of all activities provided in connection or otherwise associated with the Lands, New Metrolinx Infrastructure and New Third Party Infrastructure by any Governmental Authority or Emergency Service Provider, and includes the Contracting Authority Activities.
- 1.214 “**Governmental Authority**” means any federal, provincial, territorial, regional, municipal or local governmental authority, quasi-governmental authority, court, government or self-regulatory organization, commission, board, tribunal, organization, or any regulatory, administrative or other agency, or any political or other subdivision, department, or branch of any of the foregoing, having legal jurisdiction in any way over Contracting Authority, any aspect of the performance of the Project Agreement, the operation of the System or the Governmental Activities, in each case to the extent it has or performs legislative, judicial, regulatory, administrative or other functions within its jurisdiction.
- 1.215 “**Ground Instrument Monitoring Plan**” or “**GIMP**” means an instrumentation and monitoring plan for vibration and/ or settlement that is in accordance with the recommendation from a qualified Geotechnical Engineer and that is reviewed by a Professional Engineer who are both qualified to practice in Ontario. The plan shall include monitoring tracks, adjacent neighbouring structures and any other structure underground or above ground that may be impacted by the Works.
- 1.216 “**Guaranteed Price**” is the amount referred to in Section 3.1(a) of the Project Agreement.
- 1.217 “**H&S Certification Default Event**” has the meaning given in Section 11.25(b) of the Project Agreement.

- 1.218 “**H&S Certification Maintenance Plan**” has the meaning given in Section 11.25(b)(vii)(B) of the Project Agreement.
- 1.219 “**H&S Certification Reinstatement Plan**” has the meaning given in Section 11.25(b)(vi)(B) of the Project Agreement.
- 1.220 “**H&S Construction Inspection**” has the meaning given in Section 15.1(b) of the Project Agreement.
- 1.221 “**H&S Construction Inspection Report**” has the meaning given in Section 15.1(d) of the Project Agreement.
- 1.222 “**H&S Construction Re-Inspection**” has the meaning given in Section 15.1(e)(ii) of the Project Agreement.
- 1.223 “**H&S Construction Re-Inspection Report**” has the meaning given in Section 15.1(e)(iii) of the Project Agreement.
- 1.224 “**Handover**” means, as applicable, the successful handover, by Project Co of the New Third Party Infrastructure to Contracting Authority or, where Notice of Delegation has been provided by Contracting Authority, to the applicable third party owner, in accordance with Section 25.15 of the Project Agreement including, for clarity, the receipt of Contracting Authority’s or the applicable third party owner’s (as the case may be) confirmation that Handover has been successfully achieved and the provision of the Notice to Contracting Authority in accordance with Section 25.15(g) of the Project Agreement.
- 1.225 “**Handover Certificate**” means a Handover Certificate in accordance with the Rail Corridors Standard Practices, Rail Corridor Infrastructure Handover Protocol (RC-0503-01).
- 1.226 “**Hazardous Material Survey Reports**” means:
- (a) [REDACTED]; and
 - (b) [REDACTED].
- 1.227 “**Hazardous Substances**” means any contaminant, pollutant, mould, dangerous substance, toxic substance, liquid waste, industrial waste, gaseous waste, hauled liquid waste, hazardous material, or hazardous substance as defined in or identified pursuant to any Applicable Law.
- 1.228 “**Hazardous Waste Soils**” has the meaning given in Section 18.2(c)(ii)(A) of the Project Agreement.
- 1.229 “**Hedge Provider**” means a person that has entered into a Hedging Agreement with Project Co pursuant to the Lending Agreements, together with their successors and permitted assigns.
- 1.230 “**Hedging Agreement**” means an agreement relating to the hedging of interest rate risk entered into by Project Co and the Hedge Provider(s) pursuant to the Lending Agreements.

- 1.231 “**Highway Traffic Act (Ontario)**” means the *Highway Traffic Act*, R.S.O. 1990, c. H.8, as amended from time to time.
- 1.232 “**HST**” means the value-added tax imposed pursuant to Part IX of the *Excise Tax Act* (Canada), and any successor legislation thereto.
- 1.233 “**Hydrogeological Report**” [REDACTED].
- 1.234 “**IC Interim Completion Deliverables Confirmation**” has the meaning given in Section 24.4(c)(i) of the Project Agreement.
- 1.235 “**IC Interim Completion Deliverables Deficiencies List**” has the meaning given in Section 24.4(c)(ii) of the Project Agreement.
- 1.236 “**IC Substantial Completion Deliverables Confirmation**” has the meaning given in Section 25.4(c)(i) of the Project Agreement.
- 1.237 “**IC Substantial Completion Deliverables Deficiencies List**” has the meaning given in Section 25.4(c)(ii) of the Project Agreement.
- 1.238 “**IHSA**” means Infrastructure Health and Safety Association, a not-for-profit occupational safety organization formed on January 1, 2010 that provides health and safety training material and services to Ontario construction, electrical utilities and transportation industries, and is accredited in Ontario to issue and grant Certificates of Recognition and Letters of Good Standing, or such other person so accredited in Ontario to issue and grant Certificates of Recognition and Letters of Good Standing.
- 1.239 “**Incident**” means an unforeseen event or occurrence, which may not result in death, injury, or damage to property or process, and includes near-misses and Accidents.
- 1.240 “**Incident Management Plan**” means the plan to be included in Project Co’s Access Management Plan, as required in Schedule 10 – Review Procedure.
- 1.241 “**In-Service Certificate**” means an In-Service Certificate in accordance with the Rail Corridors Standard Practices, Rail Corridor Infrastructure Handover Protocol (RC-0503-01).
- 1.242 “**Income Tax Act (Canada)**” means the *Income Tax Act*, R.S.C., 1985, c. 1, as amended from time to time.
- 1.243 “**Indemnifiable Taxes**” has the meaning given in Section 4.20(b) of the Project Agreement.
- 1.244 “**Indemnifier**” has the meaning given in Section 46.3(a) of the Project Agreement.
- 1.245 “**Independent Certifier**” means the person appointed as the Independent Certifier pursuant to the Independent Certifier Agreement and as may be permitted pursuant to the Project Agreement.
- 1.246 “**Independent Certifier Agreement**” means the contract entered into between Project Co, Contracting Authority and the Independent Certifier in substantially the form attached hereto as Schedule 6 – Independent Certifier Agreement.

- 1.247 “**Indirect Losses**” has the meaning given in Section 47.1(a) of the Project Agreement.
- 1.248 “**Ineligible Cost Increase**” means any cost increase attributable to,
- (a) Works that Project Co could have self-performed but elected to have the Category 1 Utility Company perform on Project Co’s behalf;
 - (b) Works carried out during an Embargo Period;
 - (c) any failure by Project Co to diligently enforce the applicable Utility Agreement and to diligently monitor a Category 1 Utility Company’s compliance with the applicable Utility Agreement; or
 - (d) a failure by Project Co to carry out its obligations in accordance with the Project Agreement including, for clarity, a failure of Project Co to comply with a Utility Agreement or a failure of Project Co to coordinate the Utility Infrastructure Work.
- 1.249 “**Inferred Rail Corridor Contamination**” has the meaning given in Section 18.2(c)(i) of the Project Agreement.
- 1.250 “**Infringing Material**” has the meaning given in Section 46.1(g) of the Project Agreement.
- 1.251 “**Injurious Affection**” has the meaning given in the *Expropriations Act*, R.S.O. 1990, c. E. 26, as amended from time to time.
- 1.252 “**Innovation Proposal**” has the meaning given in Section 31.2(b) of the Project Agreement.
- 1.253 “**Inspection and Test Plan**” has the meaning given in Schedule 11 – Quality Management.
- 1.254 “**Inspection and Test Sub-Plans**” has the meaning given in Schedule 11 – Quality Management.
- 1.255 “**Insurance**” means the insurance contemplated in Schedule 25 – Insurance and Performance Security Requirements.
- 1.256 “**Insurance Policies**” has the meaning given in Schedule 30 – Insurance Trust Agreement.
- 1.257 “**Insurance Proceeds**” has the meaning given in Schedule 30 – Insurance Trust Agreement.
- 1.258 “**Insurance Trust Account**” means [REDACTED].
- 1.259 “**Insurance Trust Agreement**” means the insurance trust agreement to be entered into between Contracting Authority, the Lenders’ Agent, Project Co and the Account Trustee in the form set out in Schedule 30 – Insurance Trust Agreement.
- 1.260 “**Intellectual Property**” means all intellectual and industrial property, including: (i) Trade-Marks; (ii) Patents; (iii) Copyrights; (iv) inventions, whether or not patentable, whether or not reduced to practice or whether or not yet made the subject of a pending patent application or applications; (v) ideas and conceptions of potentially patentable subject matter, including any patent disclosures, whether or not reduced to practice and whether or not yet made the subject of a pending patent

application or applications; (vi) trade secrets and confidential, technical or business information (including ideas, formulas, compositions, designs, inventions, and conceptions of inventions whether patentable or unpatentable and whether or not reduced to practice); (vii) whether or not confidential, technology (including know-how and show-how), manufacturing and production processes and techniques, methodologies, research and development information, drawings, specifications, designs, plans, proposals, technical data, copyrightable works, marketing and business data, pricing and cost information, business and marketing plans; (viii) copies and tangible embodiments of all the foregoing, in whatever form or medium; (ix) all rights to obtain and rights to apply for any of the foregoing and all rights therein provided by multinational treaties or conventions; (x) all rights under any agreements or instruments with respect to items in (i) to (ix) above; and (xi) all rights to sue and recover and retain damages and costs and attorneys' fees for present and past infringement or other violation of any of the intellectual property rights hereinabove set out.

- 1.261 **“Intellectual Property Rights”** means all right, title and interest in, to and under the Intellectual Property in or associated with the Project Data and all Intellectual Property which, or the subject matter of which, is at any time before or after Commercial Close created, brought into existence, acquired, used or intended to be used by Project Co, any Subcontractor or by other third parties (for such third parties' use by or on behalf of or for the benefit of Project Co) for any or all of the purposes of:
- (a) the Works, including the design and construction of the New Metrolinx Infrastructure and the New Third Party Infrastructure (excluding Intellectual Property Rights of third parties, such as CAD software, that is used only in the process of design and construction); or
 - (b) the Project Agreement.
- 1.262 **“Interest Reference Rate”** means the reference benchmark rate of interest identified in the Financial Model and used in the calculation of the Project Debt Interest Cost, and for greater clarity, is the base rate of interest exclusive of any stated or imbedded spread, (including credit, swap or other types of spread) or fees.
- 1.263 **“Interim Baseline Works Schedule”** has the meaning given in Schedule 12 – Works Schedule Requirements.
- 1.264 **“Interim Completion”** means the point at which, in each case in accordance with the Project Agreement,
- (a) the Interim Completion Works have been completed;
 - (b) all requirements for Interim Completion described in the Interim Completion Commissioning Program, other than in respect of Interim Completion Minor Deficiencies, have been satisfied;
 - (c) GO train service is shifted to the New Mainline West Track; and
 - (d) the Diversion Track is decommissioned.

- 1.265 “**Interim Completion 10-Day Notice**” has the meaning set out in Section 24.4(a) of the Project Agreement.
- 1.266 “**Interim Completion Commissioning Program**” means the program to be jointly developed and agreed to by Contracting Authority and Project Co in accordance with Section 24.2 of the Project Agreement.
- 1.267 “**Interim Completion Contracting Authority Commissioning**” means the commissioning activities to be carried out by Contracting Authority in accordance with the Interim Completion Commissioning Program.
- 1.268 “**Interim Completion Contracting Authority Commissioning Period**” means the period during which Contracting Authority is performing the Interim Completion Contracting Authority Commissioning.
- 1.269 “**Interim Completion Contracting Authority Commissioning Tests**” means all commissioning tests required to be performed by Contracting Authority pursuant to the Interim Completion Commissioning Program.
- 1.270 “**Interim Completion Certificate**” means the certificate to be issued by the Independent Certifier in accordance with Section 24.4(d) of the Project Agreement.
- 1.271 “**Interim Completion Countdown Notice**” has the meaning given in Section 24.8(a) of the Project Agreement.
- 1.272 “**Interim Completion Date**” means the date on which Interim Completion is achieved as evidenced by the Interim Completion Certificate, as such date shall be stated therein.
- 1.273 “**Interim Completion Deliverables**” has the meaning given in Section 24.8(e).
- 1.274 “**Interim Completion Deliverables List**” has the meaning given in Section 24.8(e).
- 1.275 “**Interim Completion LD Commencement Date**” has the meaning given in Schedule 21 – Liquidated Damages and Construction Enforcement Regime.
- 1.276 “**Interim Completion Minor Deficiencies**” means any defects, deficiencies and items of outstanding work (including in relation to seasonal work) arising from or related to the work required to achieve Interim Completion, and that would not materially impair:
- (a) the public’s, System Users’, or Contracting Authority’s use and enjoyment of the Interim Completion Works (including any Interim Completion Contracting Authority Commissioning);
 - (b) the performance of the Governmental Activities; or
 - (c) safety, security, or traffic or track flow on the Interim Completion Works in any relevant respect.

- 1.277 “**Interim Completion Minor Deficiencies List**” has the meaning given in Section 24.9(a) of the Project Agreement.
- 1.278 “**Interim Completion Notice**” has the meaning given in Section 24.4(b) of the Project Agreement.
- 1.279 “**Interim Completion Project Co Commissioning**” means the commissioning activities to be carried out by Project Co prior to the issuance of the Interim Completion Certificate in accordance with the Interim Completion Commissioning Program.
- 1.280 “**Interim Completion Project Co Commissioning Tests**” means all commissioning tests required to be performed by Project Co pursuant to the Interim Completion Commissioning Program.
- 1.281 “**Interim Completion Works**” means the portion of the Works in respect of the design, construction, installation, testing, commissioning and completion of the following:
- (a) Metrolinx, as owner of the New Mainline West Track, and Project Co have signed an In-Service Certificate for the New Mainline West Track including the North Cut Over and South Cut Over;
 - (b) Metrolinx, as owner of the Rail Grade Separation Structures, and Project Co have signed In-Service Certificates for the portion of the Rail Grade Separation Structures, as required to run GO train and freight service on the New Mainline West Track;
 - (c) new noise barrier walls erected on completed portions of the Rail Grade Separation Structures identified in (b) above and as specified in Article 9 of Schedule 15;
 - (d) Metrolinx, as owner of the new rail signals infrastructure, and Project Co have signed an In-Service Certificate for the new rail signals infrastructure;
 - (e) Portions of the new Stormwater Management Facilities along the Rail Grade Separation Structures, as required, to provide drainage of the completed portions of the New Mainline West Track and Rail Grade Separation Structures identified in (b) above and as specified in Schedule 15. For clarity, Project Co shall not be required to meet all requirements of the Stormwater Management Facilities pursuant to Schedule 15-2, Section 4.4(k) for the purposes of the Interim Completion Works;
 - (f) CCTV System to provide 100% coverage of the Rail Grade Separation Structures identified in (b) above and as specified in Schedule 15;
 - (g) egress lighting for the Rail Grade Separation Structures identified in (b) above and as specified in Schedule 15;
 - (h) fire life safety requirements for the Rail Grade Separation Structures identified in (b) above and as specified in Schedule 15; and
 - (i) security and access control system and fencing for the Rail Grade Separation Structures identified in (b) above and as specified in Schedule 15.
- 1.282 “**Internal Quality Audit**” has the meaning given in Schedule 11 – Quality Management.

- 1.283 “**IO**” or “**Infrastructure Ontario**” means Ontario Infrastructure and Lands Corporation, a Crown agent continued under the *Ontario Infrastructure and Lands Corporation Act, 2011*, S.O. 2011.
- 1.284 “**Irrecoverable Tax**” has the meaning given in Section 4.16(b) of the Project Agreement.
- 1.285 “**Jointly Developed Materials**” have the meaning given in Section 41.4(a) of the Project Agreement.
- 1.286 “**Junior Debt Amount**” has the meaning given in Schedule 23 – Compensation on Termination.
- 1.287 “**Junior Debt Service Amount**” means, for any period, the principal and interest payable by Project Co or any Project Co Party to the Junior Lenders in the normal course under the Lending Agreements.
- 1.288 “**Junior Lenders**” means any lenders to Project Co which are subordinate in interest to the Senior Lenders and for greater clarity, excludes: (i) the Hedge Provider(s) or any other hedge providers and their respective permitted successors and assigns; and (ii) any Affiliate of Project Co or a Project Co Party.
- 1.289 “**Key Individuals**” means those Project Co Parties listed in Schedule 9 – Key Individuals.
- 1.290 “**Key Individuals Category A**” means those Key Individuals who are indicated as being in Category “A” in Schedule 9 – Key Individuals.
- 1.291 “**Labour and Material Payment Bond**” means, collectively, the Labour and Material Payment Bond and the Multiple Obligee Rider to Labour and Material Payment Bond in the form attached as Appendix C to Schedule 25 – Insurance and Performance Security Requirements.
- 1.292 “**Lands**” has the meaning given in Schedule 20 – Lands.
- 1.293 “**Legislative Holdback**” means the basic holdback to be retained pursuant to section 22(1) of the Construction Act.
- 1.294 “**Legislative Holdback Payment Date**” means the date for payment of the Legislative Holdback pursuant to Section 4.5(e) of the Project Agreement.
- 1.295 “**Lenders**” means any or all of the persons acting arm’s length to Project Co and each Project Co Party who provide the Financing, and for greater clarity, excludes the Hedge Provider(s) or any other hedge providers and their respective permitted successors and assigns and any Affiliate of Project Co or a Project Co Party.
- 1.296 “**Lenders’ Agent**” has the meaning given in Schedule 4 – Lenders’ Direct Agreement.
- 1.297 “**Lenders’ Consultant**” means any consultant appointed from time to time by the Lenders. Nothing contained in the Project Documents and no action taken by the Lenders’ Consultant in connection with the Works or the Project Documents shall constitute direction and/or control by Contracting Authority, Project Co or the Lenders.

- 1.298 “**Lenders’ Direct Agreement**” means the direct agreement to be entered into between Contracting Authority, the Lenders’ Agent and Project Co in the form set out in Schedule 4 – Lenders’ Direct Agreement.
- 1.299 “**Lending Agreements**” means any or all of the agreements or instruments to be entered into by Project Co or any of its Affiliates relating to the Financing, including, for greater certainty, the Security Documents and the Hedging Agreements.
- 1.300 “**Letter of Credit Provider**” means the provider of a Standby Letter of Credit, and “**Letter of Credit Provider(s)**” means all providers of the Standby Letter(s) of Credit.
- 1.301 “**Letter of Good Standing**” means the document issued by IHSA to a person confirming that the internal maintenance audit performed by such person regarding its health and safety management systems has been approved by IHSA, and that such person has successfully completed such internal audit pursuant to the terms and conditions of the COR Program.
- 1.302 “**Licensor**” has the meaning given in Schedule 24 – Intellectual Property.
- 1.303 “**Lighting and Illumination Plan**” a lighting plan that is designed by a lighting professional, that demonstrates compliance with DRM requirements, controls light pollution and preserve the night sky, as required in Schedule 10 – Review Procedure.
- 1.304 “**Limitations Act, 2002 (Ontario)**” means the *Limitations Act, 2002*, S.O. 2002, c.24, as amended from time to time.
- 1.305 “**Limited Modification Rights**” has the meaning given in Schedule 24 – Intellectual Property.
- 1.306 “**Listed Project Co PLAA**” means those Permits, Licences, Approvals and Agreements listed in Appendix A-2 to this Schedule 1 – Definitions and Interpretation.
- 1.307 “**Longstop Date**” has the meaning given in Section 36.1(a)(ii) of the Project Agreement.
- 1.308 “**Main Section New Mainline Track**” has the meaning given in Schedule 15 – Output Specifications.
- 1.309 “**Mainline Track**” has the meaning given in Schedule 15 – Output Specifications.
- 1.310 “**Maintenance Plan**” has the meaning given in Schedule 15 – Output Specifications.
- 1.311 “**Major Drainage System**” has the meaning given in Schedule 15 – Output Specifications.
- 1.312 “**Major Non-Conformance**” means any Non-Conformance, or combination of Minor Non-Conformances, that:
- (a) contains significant deficiencies or does not generally conform with the requirements of the Project Agreement; or
 - (b) the continued existence of which is reasonably expected to result in Project Co becoming unable to satisfy the requirements of Interim Completion or Substantial Completion.

- 1.313 “**Major Track Closure**” has the meaning given in Schedule 34 – Rail Corridor Access and Flagging.
- 1.314 “**Major Track Closure Adjustment**” has the meaning given in Schedule 34 – Rail Corridor Access and Flagging.
- 1.315 “**Make Good**”, “**Made Good**”, “**Making Good**” and derivatives thereof, means, as applicable, repairing, restoring, refurbishing, rehabilitating, removing and replacing or performing filling operation on: (a) the Works as required under the Project Agreement; or (b) any existing components disturbed (including Existing Infrastructure) due to the Works, to at least the condition existing at the commencement of the Works, in terms of construction integrity, finishes, alignment with existing adjoining surfaces, compatibility of materials, sound attenuation criteria, exfiltration/infiltration requirements, air/vapour barrier and thermal continuity.
- 1.316 “**Mechanically Stabilized Earth Walls**” or “**MSE Walls**” has the meaning given in Schedule 15 – Output Specifications.
- 1.317 “**Metrolinx**” means Metrolinx, a non-share capital corporation continued under the *Metrolinx Act, 2006*, S.O. 2006, c.16 and a Crown agency in accordance with the *Crown Agency Act*, R.S.O. 1990, c.48 and includes all operating divisions thereof and any successors thereto.
- 1.318 “**Metrolinx Access/Easement Lands**” has the meaning given in Schedule 20 – Lands.
- 1.319 “**Metrolinx Act, 2006 (Ontario)**” means the *Metrolinx Act, 2006*, S.O. 2006, c.16, as amended from time to time.
- 1.320 “**Metrolinx Lands**” has the meaning given in Schedule 20 – Lands.
- 1.321 “**Metrolinx Temporary Easements Lands**” has the meaning given in Schedule 20 – Lands.
- 1.322 “**Metrolinx Track Worker Safety Instructions**” has the meaning given in Schedule 34 – Rail Corridor Access and Flagging.
- 1.323 “**MFIPPA**” means the *Municipal Freedom of Information and Protection of Privacy Act (Ontario)*, R.S.O. 1990, c. M.56, as amended from time to time.
- 1.324 “**Milestone Payment**” means the First Milestone Payment and the Second Milestone Payment, as applicable.
- 1.325 “**Milestone Payment Completion**” means,
- (a) for the First Milestone Payment,
 - (i) Project Co incurring no less than 60% of the Total Capital Costs; and
 - (b) for the Second Milestone Payment,
 - (i) Project Co incurring no less than 80% of the Total Capital Costs.

- 1.326 “**Milestone Payment Completion Countdown Notice**” has the meaning given in Section 25A.1(a) of the Project Agreement.
- 1.327 “**Milestone Payment Completion Date**” means either the First Milestone Payment Completion Date or the Second Milestone Payment Completion Date, as applicable, and the term “**Milestone Payment Completion Dates**” means both the First Milestone Payment Completion Date and the Second Milestone Completion Date.
- 1.328 “**Milestone Payment Completion Notice**” has the meaning given in Section 25A.2(b) of the Project Agreement.
- 1.329 “**Milestone Payment Date**” means the date that is two Business Days after the applicable Milestone Payment Completion Date.
- 1.330 “**Ministry of Transportation Ontario**” or “**MTO**” means Her Majesty the Queen in right of Ontario, as represented by the Minister of Transportation, and includes any successors thereto or persons exercising delegate power and such Minister’s authority.
- 1.331 “**Minor Deficiencies**” means any defects, deficiencies and items of outstanding work (including Seasonal Minor Deficiencies) arising from or related to the work required to achieve Substantial Completion, and that would not materially impair:
- (a) the public’s, System Users’, or Contracting Authority’s use and enjoyment of the New Metrolinx Infrastructure or any third parties use and enjoyment of their respective New Third Party Infrastructure (including any Contracting Authority Commissioning);
 - (b) the performance of the Governmental Activities; or
 - (c) safety, security, or traffic or track flow on the New Metrolinx Infrastructure or New Third Party Infrastructure in any relevant respect.
- 1.332 “**Minor Deficiencies Completion Date**” has the meaning given in Section 25.11(b) of the Project Agreement.
- 1.333 “**Minor Deficiencies List**” has the meaning given in Section 25.9(a) of the Project Agreement.
- 1.334 “**Minor Drainage System**” has the meaning given in Schedule 15 – Output Specifications.
- 1.335 “**Minor Non-Conformance**” means any Non-Conformance that:
- (a) generally conforms to the requirements of the Project Agreement, but in which immaterial deficiencies have been found; or
 - (b) the continued existence of which is not reasonably expected to result in Project Co becoming unable to satisfy the requirements for, (i) Interim Completion but may result in Interim Completion Minor Deficiency; or (ii) Substantial Completion but may result in a Minor Deficiency.

- 1.336 “**Minor System User Contamination**” means Contamination where the costs of clean up or remediation shall not exceed \$[REDACTED] on a per occurrence basis (and not in the aggregate).
- 1.337 “**Minor Track Closure**” has the meaning given in Schedule 34 – Rail Corridor Access and Flagging.
- 1.338 “**Modification**” has the meaning given in Schedule 24 – Intellectual Property.
- 1.339 “**MOECC**” means the Ontario Ministry of the Environment and Climate Change, and any successor ministry thereto.
- 1.340 “**MOI**” means Her Majesty the Queen in right of Ontario as represented by the Minister of Infrastructure and includes any successors thereto or persons exercising delegated power under the Minister’s authority.
- 1.341 “**MOL**” means Her Majesty the Queen in right of Ontario as represented by the Minister of Labour and includes any successors thereto or persons exercising delegated power under the Minister’s authority.
- 1.342 “**Monthly Non-Conformance Report**” has the meaning given in Schedule 11 – Quality Management.
- 1.343 “**Multiple Obligee Rider to Labour and Material Payment Bond**” means the Multiple Obligee Rider amending the Labour and Material Payment Bond to add Contracting Authority and Lenders’ Agent as additional named Obligees, in the form attached as Exhibit 1 to Appendix C of Schedule 25 – Insurance and Performance Security Requirements.
- 1.344 “**Multiple Obligee Rider to Performance Bond**” means the Multiple Obligee Rider amending the Performance Bond to add Contracting Authority and Lenders’ Agent as additional named Obligees, in the form attached as Exhibit 1 to Appendix B of Schedule 25 – Insurance and Performance Security Requirements.
- 1.345 “**Municipal Jointly Developed Materials**” has the meaning given in Section 41.4(a)(ii) of the Project Agreement.
- 1.346 “**Municipal Lands**” has the meaning given in Schedule 20 – Lands.
- 1.347 “**Municipal Road Allowance**” has the meaning given in Schedule 20 – Lands.
- 1.348 “**Municipality**” means [REDACTED].
- 1.349 “**Municipal Standards**” means [REDACTED].
- 1.350 “**Municipal Transit System**” means any operating transit system that Project Co may encounter during the performance of its obligations under this Project Agreement.
- 1.351 “**NCR**” has the meaning given in Schedule 21 – Liquidated Damages and Construction Enforcement Regime.

- 1.352 “**Near-Miss**” means an event or circumstance (close call) that has the potential to cause serious injury, property damage or unexpected death but did not occur due to chance, corrective action and or timely intervention.
- 1.353 “**New Elevated Guideway**” has the meaning given in Schedule 15 – Output Specifications.
- 1.354 “**New Mainline Track**” has the meaning given in Schedule 15 – Output Specifications.
- 1.355 “**New Mainline West Track**” has the meaning given in Schedule 15 – Output Specifications.
- 1.356 “**New Metrolinx Infrastructure**” means the new, modified or improved infrastructure at the Lands as described in Schedule 15 – Output Specifications, including the Rail Grade Separation Works and all structures, systems and facilities and all associated data, records, drawings, plans, reports and systems and excludes, for clarity, New Third Party Infrastructure.
- 1.357 “**New Paton Road Pedestrian Underpass**” has the meaning given in Schedule 15 – Output Specifications.
- 1.358 “**New Third Party Infrastructure**” means new infrastructure as described in Schedule 15 – Output Specifications, to be installed, relocated, upgraded, designed and/or built by Project Co, for third parties,
- (a) in accordance with the Project Agreement; and
 - (b) in the case of new infrastructure to be constructed for the [REDACTED], in accordance with the Project Agreement, with reference to the Municipal Standards.
- 1.359 “**New Utility Company Infrastructure**” means the New Third Party Infrastructure to be installed, relocated, upgraded, abandoned, reinstated, restored, designed and/or built by Project Co in accordance with the Project Agreement and the specifications of the Utility Companies as of the Technical Submission Deadline.
- 1.360 “**New Wallace Avenue Rail Bridge**” has the meaning given in Schedule 15 – Output Specifications.
- 1.361 “**No Default Payment Compensation Amount**” means, [REDACTED].
- 1.362 “**Noise and Vibration Survey**” has the meaning given in Schedule 17 – Environmental Obligations.
- 1.363 “**Non-Conformance**” has the meaning given in Schedule 11 – Quality Management.
- 1.364 “**Non-Conformance Report**” has the meaning given in Schedule 11 – Quality Management.
- 1.365 “**Non-Conformance Tracking System**” has the meaning given in Schedule 11 – Quality Management.
- 1.366 “**Non-Default Termination Sum**” has the meaning given in Schedule 23 – Compensation on Termination.

- 1.367 “**Non-Resident**” means a person that is, at the relevant time, a non-resident of Canada for the purposes of the *Income Tax Act* (Canada).
- 1.368 “**North Cut Over**” has the meaning given in Schedule 15 – Output Specifications.
- 1.369 “**Notice**” has the meaning given in Section 51.1(a) of the Project Agreement.
- 1.370 “**Notice of Delegation**” has the meaning given in Section 25.15(b) of the Project Agreement.
- 1.371 “**Notice of Project**” means a notice of project filed with the Ministry of Labour in compliance with O. Reg 213/91 under the *Occupational Health and Safety Act* (Ontario).
- 1.372 “**Occupational Health and Safety Act (Ontario)**” means the *Occupational Health and Safety Act*, R.S.O. 1990, C. o.1, as amended from time to time.
- 1.373 “**OHSAS 18001**” means the international standard for occupational health and safety management systems developed by the Occupational Health and Safety Advisory Services Project Group, a British body formed to develop the standard.
- 1.374 “**OHSAS 18001 Accreditation**” means, in respect of a person, such person having received certification in respect of its health and safety management systems that such systems comply with the requirements of OHSAS 18001.
- 1.375 “**Ontario Heritage Act (Ontario)**” means the *Ontario Heritage Act*, R.S.O. 1990, c. O.18, as amended from time to time.
- 1.376 “**Ontario Infrastructure and Lands Corporation Act, 2011, S.O. 2011**” or “**Ontario Infrastructure and Lands Corporation Act**” means the Ontario Infrastructure and Lands Corporation Act, 2011, S.O. 2011, c. 9, Sch. 32, as amended from time to time.
- 1.377 “**Open Data Directive**” means the Management Board of Cabinet’s Open Data Directive dated April 29, 2016, as may be amended from time to time.
- 1.378 “**Operator**” means any person directly engaged by Metrolinx to carry out the Operator Tasks.
- 1.379 “**Operator Tasks**” means all of the tasks to be performed by the Operator in connection with the operation of the System.
- 1.380 “**Order**” has the meaning given in Schedule 30 – Insurance Trust Agreement.
- 1.381 “**Original Eligible Utilities Cost**” means the total aggregate Eligible Utilities Costs as set out in the Final Utility Baseline Document.
- 1.382 “**Other Contractor**” means an Additional Contractor or a Third Party Contractor.
- 1.383 “**Other Works**” means the Additional Works and the Third Party Works.
- 1.384 “**Outline Commissioning Program**” means all activities and requirements related to commissioning, including the associated commissioning standards, specifications, procedures,

submittals and other obligations as set out in this Schedule 14 – Outline Commissioning Program and Handover and in Schedule 15 – Output Specifications.

- 1.385 **“Output Specifications”** means Schedule 15 – Output Specifications.
- 1.386 **“Overhead Catenary System”** or **“OCS”** has the meaning given in Schedule 15 – Output Specifications.
- 1.387 **“Ownership”** has the meaning given in Schedule 24 – Intellectual Property.
- 1.388 **“PAR Meeting”** has the meaning given in Section 14.6(f) of the Project Agreement.
- 1.389 **“PAR Meeting Expiry Date”** has the meaning given in Section 14.6(g) of the Project Agreement.
- 1.390 **“Party”** means either Contracting Authority or Project Co, and **“Parties”** means collectively Contracting Authority and Project Co, but, for greater certainty, such definitions do not include MOI.
- 1.391 **“Patents”** includes all national (including the United States and Canada), regional and multinational statutory invention registrations, patents, patent registrations, patent applications, provisional patent applications, industrial designs, industrial models, including all reissues, divisions, continuations, continuations-in-part, extensions and re-examinations, and all rights therein provided by multinational treaties or conventions and all improvements to the inventions disclosed in each such registration, patent or application.
- 1.392 **“Payment Certifier”** means the professional architect of record or the engineer of record for the Project.
- 1.393 **“Payment Compensation Amount”** means, [REDACTED].
- 1.394 **“PCB Soils”** has the meaning given in Section 18.2(c)(ii)(B) of the Project Agreement.
- 1.395 **“Performance Bond”** means any of the Performance Bonds described in Section 17.4 of Schedule 25 – Insurance and Performance Security Requirements.
- 1.396 **“Performance Guarantee of Construction Guarantor”** means a performance guarantee given by the Construction Guarantor in the form set out in Schedule 29 – Form of Performance Guarantee of Construction Guarantor.
- 1.397 **“Performance Standards Regulation”** means Ontario Regulation 260/08 made under the *Professional Engineers Act* (Ontario).
- 1.398 **“Permits, Licences, Approvals and Agreements”** means the Contracting Authority Permits, Licences, Approvals and Agreements and the Project Co Permits, Licences, Approvals and Agreements.
- 1.399 **“Permitted Borrowing”** means:
- (a) any advance to Project Co under the Lending Agreements;

- (b) any additional financing approved by Contracting Authority in accordance with Section 1.9 of Schedule 22 – Variation Procedure to the Project Agreement; and
- (c) any amendment, waiver or exercise of a right under the Lending Agreements made during the Step-in Period that does not increase Contracting Authority’s liabilities under the Project Agreement whether actual or contingent, present or future, known or unknown.
- 1.400 **“Personal Information”** means all personal information (as the term “personal information” is defined in the *Personal Information Protection and Electronic Documents Act* (Canada)) in the custody or control of Project Co or any Project Co Party other than personal information of the employees of Project Co or the Project Co Parties and other than personal information that is wholly unrelated to the Works and not derived directly or indirectly from Contracting Authority in respect of the Project.
- 1.401 **“Personal Information Protection and Electronic Documents Act (Canada)”** means the Personal Information Protection and Electronic Documents Act, S.C. 2000, c. 5, as amended from time to time.
- 1.402 **“Plant”** means all buildings, building services, infrastructure, building fabric, and mechanical and electrical services, which are required to meet the operational needs of Contracting Authority as defined in Schedule 15 – Output Specifications.
- 1.403 **“Police Service”** means the Royal Canadian Mounted Police, the Ontario Provincial Police, the Toronto Police Service and any other law enforcement agency with jurisdiction pursuant to Applicable Law, as applicable.
- 1.404 **“Prequalification Submission”** means Project Co’s response to the request for qualifications issued in respect of the Project on August 17, 2017.
- 1.405 **“Prequalified Subcontractor”** means any Subcontractor that was identified in the list of subcontractors submitted as part of Project Co’s Prequalification Submission, as amended pursuant to the process set out in the Request for Proposals.
- 1.406 **“Proceeding at Risk”** means that Project Co is proceeding with the Works in a manner determined by the Independent Certifier to constitute a valid Proceeding at Risk Matter in the Independent Certifier’s opinion, based on the Independent Certifier’s analysis of Critical Non-Conformance criteria, its review and analysis of Contracting Authority’s reasoning set out in the Proceeding at Risk Notice, Project Co’s response provided pursuant to Section 14.6(c) of the Project Agreement, and the additional information disclosed pursuant to the process set out in Section 14.6 of the Project Agreement.
- 1.407 **“Proceeding at Risk Matter”** has the meaning given in Section 14.6(a) of the Project Agreement.
- 1.408 **“Proceeding at Risk Notice”** has the meaning given in Section 14.6(a) of the Project Agreement.
- 1.409 **“Proceedings Against the Crown Act (Ontario)”** means the *Proceedings Against the Crown Act*, R.S.O. 1990, c. P.27, as amended from time to time.

- 1.410 “**Product**” means or “**Products**” mean material, machinery, equipment and fixtures forming the Works but does not include equipment or machinery used to prepare, fabricate, convey or erect the Works, which is referred to as construction machinery and equipment.
- 1.411 “**Professional Engineer**” means a person who holds a license or a temporary license as a Professional Engineer under the Professional Engineers Act, R.S.O. 1990, chapter P.28.
- 1.412 “**Progress Works Schedule**” has the meaning given in Schedule 12 – Works Schedule Requirements.
- 1.413 “**Prohibited Act**” has the meaning given in Section 50.1(a) of the Project Agreement.
- 1.414 “**Project**” has the meaning given in the recitals to the Project Agreement.
- 1.415 “**Project Agreement**” has the meaning given in the recitals to the Project Agreement.
- 1.416 “**Project Co**” has the meaning given in the introductory paragraph of the Project Agreement.
- 1.417 “**Project Co Amount**” has the meaning given in Schedule 23 – Compensation on Termination.
- 1.418 “**Project Co Commissioning**” means the commissioning activities to be carried out by Project Co prior to the issuance of the Substantial Completion Certificate in accordance with the Final Commissioning Program.
- 1.419 “**Project Co Commissioning Authority**” has the meaning given in Schedule 14 – Outline Commissioning Program and Handover.
- 1.420 “**Project Co Commissioning Tests**” means all Commissioning Tests required to be performed by Project Co pursuant to the Final Commissioning Program.
- 1.421 “**Project Co Construction Event of Default**” means a Project Co Event of Default relating to a failure or breach by Project Co to perform, observe or comply with any covenants, agreements, obligations or liabilities with respect to the Works, excluding a default by the Construction Guarantor under the Performance Guarantee of Construction Guarantor.
- 1.422 “**Project Co Default Termination Sum**” has the meaning given in Schedule 23 – Compensation on Termination.
- 1.423 “**Project Co Event of Default**” has the meaning given in Section 36.1(a) of the Project Agreement.
- 1.424 “**Project Co Group**” means [REDACTED].
- 1.425 “**Project Co Party**” means:
- (a) the Construction Contractor;
 - (b) any person engaged by Project Co and/or the Construction Contractor from time to time as may be permitted by the Project Agreement to procure or manage the provision of the Works (or any of them); and

- (c) in respect of each of the above, their subcontractors of any tier, agents, employees, officers and directors,
- and “**Project Co Parties**” shall be construed accordingly.
- 1.426 “**Project Co Permits, Licences, Approvals and Agreements**” means all permissions, consents, approvals, certificates, permits, licences, agreements and authorizations required to perform the Works in accordance with the Project Agreement and as required by Applicable Law, and including those permissions, consents, approvals, certificates, permits, licences, agreements and authorizations which are the responsibility of Project Co to obtain as set out in Appendix A to this Schedule 1 – Permits, Licences, Approvals and Agreements or which is the responsibility of Project Co to perform or fulfill as set out in Appendix A to this Schedule 1 – Permits, Licences, Approvals and Agreements and the Output Specifications and all necessary consents, approvals, certificates, permits, licences, agreements and authorizations from and with any third parties (including, to the extent applicable, all Development Approvals, Railway Approvals and Utility Agreements, and the approval of the Fire Marshal of Ontario), needed to perform the Works in accordance with the Project Agreement and as required by Applicable Law, but other than the Contracting Authority Permits, Licences, Approvals and Agreements.
- 1.427 “**Project Co Proposal Extracts**” means the documents attached as Schedule 13 – Project Co Proposal Extracts.
- 1.428 “**Project Co Representative**” means the person designated as such by Project Co on or prior to Commercial Close and any permitted replacement.
- 1.429 “**Project Co Variation Notice**” has the meaning given in Schedule 22 – Variation Procedure.
- 1.430 “**Project Data**” has the meaning given in Schedule 24 – Intellectual Property.
- 1.431 “**Project Debt Interest Cost**” means the budgeted amount of aggregate interest charges in respect of the Senior Debt Amount used to calculate the Cost of the Financing portion of the Guaranteed Price.
- 1.432 “**Project Documents**” means the Ancillary Documents and the Lending Agreements.
- 1.433 “**Project Know-How**” means all ideas, concepts, alternatives, methodologies, processes, recommendations and suggestions developed by or through Project Co or any Project Co Party and revealed to or discovered by Contracting Authority, whether before or after Commercial Close, which may be connected in any way to:
- (a) the Works, including the design and construction of the New Metrolinx Infrastructure and the New Third Party Infrastructure; or
 - (b) the Project Agreement.
- 1.434 “**Project Specific Static Signage Catalogue**” has the meaning in Schedule 10 – Review Procedure.
- 1.435 “**Project Term**” means the period commencing on the date of the Project Agreement and expiring at midnight on the Termination Date.

- 1.436 “**Project Works Schedule**” has the meaning given in Schedule 12 – Works Schedule Requirements.
- 1.437 “**Proposal Part**” means a part of Project Co’s proposal submitted in response to the RFP, including any revisions to such part of the submission that were agreed upon by Contracting Authority and Project Co as part of the RFP process.
- 1.438 “**Proposed Works Schedule**” has the meaning given in Schedule 12 – Works Schedule Requirements.
- 1.439 “**Proprietor**” has the meaning given in Section 42.6(a) of the Project Agreement.
- 1.440 “**Protesters**” has the meaning given in Section 11.13(a) of the Project Agreement.
- 1.441 “**Province**” means Her Majesty the Queen in Right of Ontario.
- 1.442 “**Province Person Third Party Beneficiaries**” has the meaning given in Section 54.17(a)(i) of the Project Agreement.
- 1.443 “**Province Persons**” means Contracting Authority Parties, including for clarity the Operator, and, while attending in their official capacity at the Lands, New Metrolinx Infrastructure or New Third Party Infrastructure, the following:
- (a) any person to which authority is designated pursuant to Section 53.1 of the Project Agreement and any agents and employees of any such person; or
 - (b) contractors of Contracting Authority or of any person to which authority is delegated pursuant to Section 53.1 of the Project Agreement and subcontractors of any tier and its or their directors, officers and employees,
- but excluding Project Co and any Project Co Party.
- 1.444 “**Qualified Track Inspector**” has the meaning set out in Schedule 9 – Key Individuals.
- 1.445 “**Quality Audit**” has the meaning given in Schedule 11 – Quality Management.
- 1.446 “**Quality Audit Plan**” has the meaning given in Schedule 11 – Quality Management.
- 1.447 “**Quality Management Plan**” has the meaning given in Schedule 11 – Quality Management.
- 1.448 “**Quality Management System**” has the meaning given in Schedule 11 – Quality Management.
- 1.449 “**Quality Plans**” means the Quality Manual, the Access Quality Management Plan, the Construction Quality Management Plan, the Design Quality Management Plan, the Environmental Quality Management Plan and the Quality Audit Plan.
- 1.450 “**Rail Corridor**” has the meaning given in Schedule 20 – Lands.

- 1.451 “**Rail Corridor Access**” has the meaning given in Schedule 34 – Rail Corridor Access and Flagging.
- 1.452 “**Rail Corridor Access Permit**” has the meaning given in Schedule 34 – Rail Corridor Access and Flagging.
- 1.453 “**Rail Corridor Raceway**” has the meaning given in Schedule 15 – Output Specifications.
- 1.454 “**Rail Grade Separation**” has the meaning given in Schedule 15 – Output Specifications.
- 1.455 “**Rail Grade Separation Lands**” has the meaning given in Schedule 20 – Lands.
- 1.456 “**Rail Grade Separation Structures**” has the meaning given in Schedule 15 – Output Specifications.
- 1.457 “**Rail Grade Separation Works**” has the meaning given in Schedule 15 – Output Specifications.
- 1.458 “**Rail Transit Specific Change in Law**” means any Change in Law which principally affects or principally relates only to the design or construction of rail transit systems.
- 1.459 “**Railway Approvals**” means all consents, approvals, permissions and agreements, and amendments thereto, required to be obtained from a Railway Company pursuant to a Railway Order or Applicable Laws, for the carrying out of Works on land or improvements of a Railway Company, but does not include any Railway Orders.
- 1.460 “**Railway Company**” means CN, CP, GO Transit and any other railway company that owns a railway, any part of which is on any part of the Lands during the Project Term.
- 1.461 “**Railway Order**” means any order of the Canadian Transportation Agency:
- (a) granted in favour of Contracting Authority allowing or providing for:
 - (i) infrastructure comprising or to comprise New Metrolinx Infrastructure or New Third Party Infrastructure to be located upon and across land or improvements of a Railway Company; and
 - (ii) the construction, maintenance and use of such infrastructure upon and across such land or improvements; or
 - (b) for the carrying out of any Works on land or improvements of a Railway Company, and all amendments thereto.
- 1.462 “**Record Drawings**” has the meaning given by the Professional Engineers of Ontario as those drawings prepared and sealed by the reviewing engineer after verifying in detail the actual conditions of the completed project.
- 1.463 “**Recoverable Tax**” has the meaning given in Section 4.16(c) of the Project Agreement.

- 1.464 “**Recovery Amount**” has the meaning given in Section 46.3(g) of the Project Agreement.
- 1.465 “**Recovery Works Schedule**” has the meaning given in Schedule 12 – Works Schedule Requirements.
- 1.466 “**Recovery Works Schedule Report**” has the meaning given in Schedule 12 – Works Schedule Requirements.
- 1.467 “**Railway Track and Grading Implementation Plan**” means the plan to be included in Project Co’s Access Management Plan, as required in Schedule 10 – Review Procedure.
- 1.468 “**Refinancing**” has the meaning given in Schedule 28 – Refinancing.
- 1.469 “**Reimbursement Event**” has the meaning given in Section 27.5(a) of the Project Agreement.
- 1.470 “**Reinstatement Plan**” has the meaning given in Section 11.9(e) of the Project Agreement.
- 1.471 “**Reinstatement Work**” has the meaning given in Section 11.9(b) of the Project Agreement.
- 1.472 “**Relevant Change in Law**” means a Discriminatory Change in Law or a Rail Transit Specific Change in Law.
- 1.473 “**Relevant Conviction**” means a charge or conviction, at any time within the previous 6 years, of any offense: (i) of moral turpitude in Canada or elsewhere; (ii) for which records exist under the *Criminal Records Act*; or (iii) otherwise designated as a Relevant Conviction by Contracting Authority from time to time, and that conviction remains in effect at that time and is one for which a pardon has not been granted.
- 1.474 “**Relevant Entity**” has the meaning given in Section 49.4(i) of the Project Agreement.
- 1.475 “**Relief Event**” has the meaning given in Section 34.1(a) of the Project Agreement.
- 1.476 “**Remainder Works**” means all Works other than the Interim Completion Works.
- 1.477 [Intentionally Deleted]
- 1.478 “**Request for Proposals**” or “**RFP**” means the request for proposals issued in respect of the Project on February 28, 2018, as amended from time to time.
- 1.479 “**Required Amount**” has the meaning given in Section 11.18(a) of the Project Agreement.
- 1.480 “**Response Action Plan**” means Response Action Plan, in accordance with Schedule 10 – Review Procedure that shall indicate methods and means to respond to various review and alert level scenarios based on types of geotechnical instruments that indicate review and alert levels.

- 1.481 **“Restricted Person”** means any person who, or any member of a group of persons acting together, any one of which:
- (a) has, directly or indirectly, its principal or controlling office in a country that is subject to any economic or political sanctions imposed by Canada or Ontario;
 - (b) has as its primary business the illegal manufacture, sale, distribution or promotion of narcotics substances or arms, or is or has been involved in terrorism;
 - (c) in the case of an individual, (i) he or she has been convicted of any indictable offence less than five years prior to the date at which the consideration of whether such individual is a “Restricted Person” is made hereunder, whether or not such person received a custodial sentence; or (ii) he or she has been sentenced to a custodial sentence, other than a suspended sentence, for any regulatory offence other than under the *Highway Traffic Act* (Ontario) or corresponding legislation in any other jurisdiction less than five years prior to the date at which the consideration of whether such individual is a “Restricted Person” is made hereunder;
 - (d) in the case of a person other than an individual, (i) it or any of the members of its (or its general partner’s) board of directors or its senior executive managers has been convicted of any indictable offence less than five years prior to the date at which the consideration of whether such person is a “Restricted Person” is made hereunder, whether or not such person received a custodial sentence; or (ii) any of the members of its (or its general partner’s) board of directors or its senior executive managers has been sentenced to a custodial sentence, other than a suspended sentence, for any regulatory offence other than under the *Highway Traffic Act* (Ontario) or corresponding legislation in any other jurisdiction less than five years prior to the date at which the consideration of whether such person is a “Restricted Person” is made hereunder;
 - (e) has as its primary business the acquisition of distressed assets or investments in companies or organizations which are or are believed to be insolvent or in a financial standstill situation or potentially insolvent;
 - (f) is subject to a material claim of Contracting Authority under any proceedings (including regulatory proceedings) which have been concluded or are pending at the time at which the consideration of whether such person is a “Restricted Person” is made hereunder, and which (in respect of any such pending claim, if it were to be successful) would, in Contracting Authority’s view, in either case, be reasonably likely materially to affect the ability of Project Co to perform its obligations under the Project Agreement; or
 - (g) has a material interest in the production of tobacco products.
- 1.482 **“Review Procedure”** means the procedure set out in Schedule 10 – Review Procedure.
- 1.483 **“RFP Submission Deadline”** means April 2, 2019.
- 1.484 **“Risk Assessment Plan”** means the plan to be included in Project Co’s Access Management Plan, as required in Schedule 10 – Review Procedure.

- 1.485 “**Risk Register**” means the tool developed and managed by Project Co which will document project risks and how Project Co is proactively managing each risk.
- 1.486 “**Schedule**” means a schedule to the Project Agreement.
- 1.487 “**Scheduled Final Completion Date**” means [REDACTED].
- 1.488 “**Scheduled First Milestone Payment Completion Date**” means [REDACTED].
- 1.489 “**Scheduled Interim Completion Date**” means [REDACTED].
- 1.490 “**Scheduled Milestone Payment Completion Date**” means either the Scheduled First Milestone Payment Completion Date or the Scheduled Second Milestone Payment Completion Date, as applicable, and the term “**Scheduled Milestone Payment Completion Dates**” means both the Scheduled First Milestone Payment Completion Date and the Scheduled Second Milestone Payment Completion Date.
- 1.491 “**Scheduled Second Milestone Payment Completion Date**” means [REDACTED].
- 1.492 “**Scheduled Substantial Completion Date**” means [REDACTED].
- 1.493 “**Seasonal Minor Deficiencies**” has the meaning given in Section 25.9(b) of the Project Agreement.
- 1.494 “**Seasonal Works Holdback**” has the meaning given in Section 25.11(b) of the Project Agreement.
- 1.495 “**Second Milestone Payment**” means \$31,663,560.41.
- 1.496 “**Second Milestone Payment Completion Date**” has the meaning given in Section 25A.2(d)(i) of the Project Agreement.
- 1.497 “**Security**” has the meaning given in Schedule 4 – Lenders’ Direct Agreement.
- 1.498 “**Security Documents**” has the meaning given in Schedule 4 – Lenders’ Direct Agreement.
- 1.499 “**Senior Debt Amount**” has the meaning given in Schedule 23 – Compensation on Termination.
- 1.500 “**Senior Debt Service Amount**” means, [REDACTED].
- 1.501 “**Senior Lenders**” means [REDACTED] and their permitted successors and assigns, and for greater clarity, excludes (i) the Hedge Provider(s) or any other hedge providers and their respective permitted successors and assigns; (ii) Junior Lenders; and (iii) any Affiliate of Project Co or a Project Co Party.
- 1.502 “**Sensitive Information**” means financial or commercial information which would, if disclosed to a competitor of Project Co or any Project Co Party, give that competitor a competitive advantage over Project Co or such Project Co Party and thereby prejudice the business of Project Co or such Project Co Party.

- 1.503 “**Severe Market Disruption**” means any occurrence of exceptional circumstances in financial markets in Europe, the United States of America and/or Canada which:
- (a) results in the suspension or cessation of all or substantially all lending activity in national or relevant international capital or interbank markets; and
 - (b) adversely affects access by Project Co to such markets.
- 1.504 “**Shop Drawings**” means drawings, diagrams, illustrations, schedules, performance charts, brochures and other data which are to be provided by Project Co to illustrate details of a portion of the Works, indicating materials, methods of construction and attachment or anchorage, erection diagrams, connections, explanatory notes and other information necessary for completion of the Works.
- 1.505 “**Site**” means, at any time and from time to time, that portion of the Lands,
- (a) on which Project Co or any Project Co Party is engaged in any construction or Demolition activities or is otherwise engaged in completing the Works;
 - (b) on which any of the Works have been commenced but not completed in their entirety;
 - (c) that are hoarded, cordoned, or otherwise fenced off by Project Co, and any Lands immediately surrounding such hoarding, cordons or fencing; or
 - (d) within the active construction footprint of the Works.
- 1.506 “**Site Conditions**” means the condition of the Lands, including the physical, geophysical, climatic, ecological, environmental, geotechnical and archaeological conditions.
- 1.507 “**Soil and Groundwater Management Strategy**” has the meaning given in Schedule 17 – Environmental Obligations.
- 1.508 “**South Cut Over**” has the meaning given in Schedule 15 – Output Specifications.
- 1.509 “**Special Senior Debt Amount**” has the meaning given in Section 33.6(a) of the Project Agreement.
- 1.510 “**Special Trackwork(s)**” has the meaning given in Schedule 15 – Output Specifications.
- 1.511 “**Specified Costs**” has the meaning given in Schedule 21 – Liquidated Damages and Construction Enforcement Regime.
- 1.512 “**Stakeholders**” means individuals and organizations with an interest in the Project, including those listed in Schedule 15 – Output Specifications, but excluding Contracting Authority.
- 1.513 “*Standards & Guidelines for Conservation of Provincial Heritage Properties*” means the Standards & Guidelines for Conservation of Provincial Heritage Properties issued under the *Ontario Heritage Act* (Ontario) on April 28, 2010, as amended from time to time.

- 1.514 “**Standby Letter of Credit**” means a letter of credit attached as Schedule 7A – Standby Letter(s) of Credit, and “**Standby Letter(s) of Credit** or **Standby Letters of Credit**” means all letters of credit attached as Schedule 7A – Standby Letter(s) of Credit.
- 1.515 “**Start-Up Meeting**” has the meaning given in Section 11.2(a) of the Project Agreement.
- 1.516 “**Step-in Period**” has the meaning given in Schedule 4 – Lenders’ Direct Agreement.
- 1.517 “**Stormwater Management Facilities**” has the meaning given in Schedule 15 – Output Specifications.
- 1.518 “**Stormwater Management Report**” means a report prepared by a registered Professional Engineer qualified in municipal engineering/stormwater management, and must include all appropriate reports, plans, computer modeling results and design calculations relating to how storm run-off is to be managed and that meets all the requirements of the City of Toronto as well as other standards and criteria applicable to the Project.
- 1.519 “**Subcontract**” or “**Subcontracts**” means the contracts entered into by or between Project Co and any Subcontractor or between any Subcontractor at any tier, including the Construction Contractor, and any other Subcontractor at any tier in relation to any aspect of the Works.
- 1.520 “**Subcontractor**” means any subcontractor of Project Co engaged by or through Project Co to perform any of the Works, including the Construction Contractor, any Supplier or consultant, and any subcontractor of any other subcontractor at any tier.
- 1.521 “**Subcontractor’s Direct Agreement**” means the agreement to be entered into among Contracting Authority, Project Co, the Construction Contractor and certain Subcontractors determined in accordance with the terms of the Project Agreement in the form set out in Schedule 3 – Subcontractor’s Direct Agreement.
- 1.522 “**Substantial Completion**” means the point at which:
- (a) the New Metrolinx Infrastructure and the New Third Party Infrastructure have been completed in accordance with the Project Agreement;
 - (b) Metrolinx, as owner of the New Metrolinx Infrastructure, and Project Co have signed Handover Certificates for all applicable New Metrolinx Infrastructure;
 - (c) the Payment Certifier appointed pursuant to Section 17.3(f) of the Project Agreement has certified the substantial performance of the Design and Construction Contract and the related certificate of substantial performance has been published, each in accordance with the Construction Act; and
 - (d) all requirements for Substantial Completion described in the Final Commissioning Program, other than in respect of Minor Deficiencies, have been satisfied in respect of the New Metrolinx Infrastructure and the New Third Party Infrastructure as a whole.
- 1.523 “**Substantial Completion 10-Day Notice**” has the meaning set out in Section 25.4(a) of the Project Agreement.

- 1.524 “**Substantial Completion Certificate**” means the certificate to be issued by the Independent Certifier in accordance with Section 25.4(d) of the Project Agreement.
- 1.525 “**Substantial Completion Date**” means the date on which Substantial Completion is achieved as evidenced by the Substantial Completion Certificate, as such date shall be stated therein.
- 1.526 “**Substantial Completion Deliverables**” has the meaning given in Section 25.8(e) of the Project Agreement.
- 1.527 “**Substantial Completion Deliverables List**” has the meaning given in Section 25.8(e) of the Project Agreement.
- 1.528 “**Substantial Completion LD Commencement Date**” has the meaning given in Schedule 21 – Liquidated Damages and Construction Enforcement Regime.
- 1.529 “**Substantial Completion Notice**” has the meaning given in Section 25.4(b) of the Project Agreement.
- 1.530 “**Substantial Completion Payment**” means [REDACTED]:
- (a) [REDACTED];
 - (b) [REDACTED]; and
 - (c) [REDACTED].
- 1.531 “**Substantial Completion Payment Date**” means [REDACTED].
- 1.532 “**Subsurface Utility Engineering (SUE) Report**” means the Subsurface Utility Engineering (SUE) Report, prepared by Hatch, dated December 2017, including all subsequent revisions.
- 1.533 “**Supplier**” means a person who supplies to Project Co, or to any Subcontractor, any equipment, materials, supplies or services as part of, or for, the Works.
- 1.534 “**Surety**” means the person issuing the Bonds.
- 1.535 “**Sustainability Plan**” means the plan to be provided by Project Co as required in Schedule 10 – Review Procedure.
- 1.536 “**System**” means the Metrolinx transit system in the Rail Corridor.
- 1.537 “**System User**” means any member of the public, any Province Person and any other person that is on or about the New Metrolinx Infrastructure or is otherwise making use of the New Metrolinx Infrastructure for any purpose, including customers, employees, consultants or contractors of Contracting Authority.
- 1.538 “**Tax**” or “**Taxes**” means any and all taxes, levies, imposts, duties, fees, withholdings, assessments, deductions or charges whatsoever, imposed, assessed, levied or collected by any Governmental Authority, together with interest thereon and penalties with respect thereto, and includes all HST

- except where stated to the contrary, provided however that “**Taxes**” shall not include the Contracting Authority Taxes.
- 1.539 “**Technical Information**” has the meaning given in Schedule 24 – Intellectual Property.
- 1.540 “**Technical Reports**” means the Environmental Reports, the Geotechnical Reports and the Archaeological Reports.
- 1.541 “**Template Third Party Agreement**” has the meaning given in Section 10.3(e) of the Project Agreement.
- 1.542 “**Temporary Construction Crossing**” means a temporary construction put in place to allow Project Co’s equipment or vehicles to cross the track.
- 1.543 “**Temporary Davenport Diamond Installation Weekend**” or “**TDDIW**” has the meaning given in Schedule 15 – Output Specifications.
- 1.544 “**Termination Date**” means the earlier of the Expiry Date and such other date, if any, on which termination of the Project Agreement takes effect in accordance with its terms.
- 1.545 “**Third Party Agreement**” has the meaning given in Section 10.3(e) of the Project Agreement.
- 1.546 “**Third Party Contractors**” means any person (not being, for the avoidance of doubt, Project Co or any Project Co Party or Additional Contractors) that carries out any Third Party Works.
- 1.547 “**Third Party Facilities**” means transit shelters, telephone facilities, infrastructure and other property of Utility Companies and Railway Companies and other public facilities and associated equipment, plant, materials and apparatus installed and operated or to be installed and operated on the Lands by any transit authority, communications provider, Utility Company, Railway Company or other third party (not including, for the avoidance of doubt, Project Co or any Project Co Party).
- 1.548 “**Third Party Lands**” has the meaning given in Schedule 20 – Lands.
- 1.549 “**Third Party Works**” means any work performed by a Third Party Contractor on the Lands, including works in relation to,
- (a) an Encumbrance;
 - (b) Existing Third Party Infrastructure;
 - (c) Third Party Facilities; and
 - (d) Utility Work and work pursuant to a Utility Agreement, Railway Order or an encroachment permit or other permitting authority of any Governmental Authority under Applicable Law.
- 1.550 “**Total Capital Costs**” is equal to the sum of the Cost of the Works and the Cost of the Financing, less the Legislative Holdback amount.

- 1.551 “**Track Protection Access**” has the meaning given in Schedule 34 – Rail Corridor Access and Flagging.
- 1.552 “**Track Protection Barrier Access**” has the meaning given in Schedule 34 – Rail Corridor Access and Flagging.
- 1.553 “**Trackwork**” has the meaning given in Schedule 15 – Output Specifications.
- 1.554 “**Trade-Marks**” means all trademarks, service marks, trade dress, logos, distinguishing guises and indicia, trade names, corporate names, business names, domain names, whether or not registered, including all common law rights, and registrations, applications for registration and renewals thereof, including, but not limited to, all marks registered in the Canadian Intellectual Property Office and the trademark offices of other nations throughout the world, and all rights therein provided by multinational treaties or conventions.
- 1.555 “**Traffic Signage Plan**” means comprehensive design drawings and documents which detail traffic signage that meets the regulatory requirements and the DRM.
- 1.556 “**Train Delay**” has the meaning given in Schedule 21 – Liquidated Damages and Construction Enforcement Regime.
- 1.557 “**Transit Project Assessment Process**” or “**TPAP**” has the meaning given in Schedule 17 – Environmental Obligations.
- 1.558 “**Tree Protection Plan**” means drawings and documents prepared by a qualified arborist that is in accordance with the requirements of City of Toronto Tree Protection Policy and Specification for Construction near Trees.
- 1.559 “**Trespassers**” has the meaning given in Section 11.13(a) of the Project Agreement.
- 1.560 “**TTC**” means the Toronto Transit Commission.
- 1.561 “**TTC PLAA Deadline**” has the meaning given in Section 11.8(g) of the Project Agreement.
- 1.562 “**Unknown Utility Infrastructure**” has the meaning given in Section 18.4(a) of the Project Agreement.
- 1.563 “**Utilities**” means energy/power supplies, communications, data transmission and waste recovery, including electricity, natural gas/fuel oil, water, sanitary waste and storm water.
- 1.564 “**Utility Agreement**” means any agreement entered into by Project Co with a Utility Company in connection with the design removal, construction, installation, repair, preservation, relocation or maintenance of Utility Infrastructure in, on, under, over or adjacent to the Lands, and includes any site or other permits issued thereunder or pursuant thereto, all as amended, supplemented or replaced from time to time.
- 1.565 “**Utility Company**” means the owner or operator of any Utility Infrastructure or any company or companies designated by Project Co to provide Utilities.

- 1.566 “**Utility Infrastructure**” means privately, publicly or cooperatively owned lines, facilities or systems for transmitting or distributing electricity, lighting, data, communications, gas, oil and petroleum products, water, storm water or sewage, wireless, or other similar commodity or substance which serve the public directly or indirectly, including underground, surface and overhead facilities as well as facilities which use common poles, ducts or conduits on a shared basis, and all related infrastructure.
- 1.567 “**Utility Infrastructure Relocation Plan**” has the meaning set out in Schedule 15 – Output Specifications.
- 1.568 “**Utility Work**” means temporary and permanent installation, protection, removal, relocation, upgrading, reinstatement, restoration, downsizing, designing, and/or building works relating to Utility Infrastructure carried out in connection with or as part of the Works, including design, construction, installation, commissioning, protection, removal and relocation of poles, pole lines, conduits, gas pipes, oil pipes, sewers and tile lines, and related and ancillary works.
- 1.569 “**Variation**” has the meaning given in Schedule 22 – Variation Procedure.
- 1.570 “**Variation Confirmation**” has the meaning given in Schedule 22 – Variation Procedure.
- 1.571 “**Variation Directive**” has the meaning given in Schedule 22 – Variation Procedure.
- 1.572 “**Variation Enquiry**” has the meaning given in Schedule 22 – Variation Procedure.
- 1.573 “**Variation Procedure**” means the procedure set out in Schedule 22 – Variation Procedure.
- 1.574 “**Vehicle, Cyclist, Pedestrian Access Plan**” means the plan to be included in Project Co’s Access Management Plan, as required in Schedule 10 – Review Procedure.
- 1.575 “**Warranty Cash Amount**” has the meaning given in Section 11.18(b) of the Project Agreement.
- 1.576 “**Warranty Letter of Credit**” has the meaning given in Section 11.18(a) of the Project Agreement.
- 1.577 “**Warranty Period**” means,
- (a) with respect to a[REDACTED], a period beginning on the Interim Completion Date and expiring on the date that is, (i) two years following the Substantial Completion Date, or (ii) such longer period as is set out in Schedule 15 – Output Specifications; and
 - (b) with respect to the Remainder Works which have achieved Substantial Completion, a period beginning on the Substantial Completion Date and expiring on the date that is, (i) two years following the Substantial Completion Date, or (ii) such longer period as is set out in Schedule 15 – Output Specifications.
- 1.578 “**Warranty Work**” has the meaning given in Section 11.17(a) of the Project Agreement.
- 1.579 “**Witness and Hold Point**” has the meaning given in Schedule 11 – Quality Management.

- 1.580 “**Workplace Safety and Insurance Act (Ontario)**” means the *Workplace Safety and Insurance Act*, S.O. 1997, c. 16, Sched. A, as amended from time to time.
- 1.581 “**Works**” means the design, construction, installation, testing, commissioning and completion of the New Metrolinx Infrastructure and the New Third Party Infrastructure, including the Interim Completion Works, the Remainder Works, the rectification of any Interim Completion Minor Deficiencies and Minor Deficiencies, the Maintenance Services, Warranty Work, all other work under the Permits, Licences, Approvals and Agreements, and all work which is implied by the Project Agreement and that is necessary for the stability or safe and proper design, construction, installation, testing, commissioning and completion of the New Metrolinx Infrastructure and the New Third Party Infrastructure, except for (i) all work which is expressly described in Appendix A to this Schedule 1 – Permits, Licences, Approvals and Agreements as being the responsibility of Contracting Authority, and (ii) any Contracting Authority Commissioning.
- 1.582 “**Works Change in Law**” means any Change in Law that:
- (a) is not a Relevant Change in Law;
 - (b) occurs after the date of the Project Agreement;
 - (c) requires Project Co to perform any work of alteration, addition, Demolition, extension or variation in the quality or function of the New Metrolinx Infrastructure or the New Third Party Infrastructure which is similar in nature to the Works but is not Works or capital replacement work which Project Co would otherwise be required to perform in order to comply with its obligations under the Project Agreement; and
 - (d) was not reasonably foreseeable at Commercial Close by an experienced contractor carrying out activities and/or performing design and/or other operations similar to those to be carried out and/or performed by any Project Co Party in relation to the Project.
- 1.583 “**Works Committee**” has the meaning given in Section 14.1(a) of the Project Agreement.
- 1.584 “**Works Report**” has the meaning given in Section 13.6(a) of the Project Agreement.
- 1.585 “**Works Schedule Report**” has the meaning given in Schedule 12 – Works Schedule Requirements.
- 1.586 “**Works Submittals**” has the meaning given in Section 1.1 of Schedule 10 – Review Procedure.
- 1.587 “**WSIB**” means the Ontario Workplace Safety and Insurance Board that is responsible for administering the *Workplace Safety and Insurance Act (Ontario)*.
2. **Interpretation.** The Project Agreement shall be interpreted according to the following provisions, unless the context requires a different meaning:
- 2.1 The tables of contents, headings, marginal notes and references to them in the Project Agreement are for convenience of reference only, shall not constitute a part of the Project Agreement, and shall not be taken into consideration in the interpretation of, or affect the meaning of, the Project Agreement.

- 2.2 Except where the context requires otherwise (irrespective of whether some, but not all, references in a Schedule specifically refer to that Schedule or to other portions of the Project Agreement) references to specific Sections, Articles, Clauses, Paragraphs, Subparagraphs, Schedules, and other divisions of the Project Agreement are references to such Sections, Articles, Clauses, Paragraphs, or Subparagraphs of, Schedules to, or divisions of the Project Agreement and the terms “Section”, “Article” and “Clause” are used interchangeably and are synonymous.
- 2.3 Except where the context requires otherwise, references to specific Sections, Articles, Clauses, Paragraphs, Subparagraphs, Schedules, and other divisions of the Project Agreement followed by a number are references to the whole of the Section, Article, Clause, Paragraph, Subparagraphs, Schedule or other division of the Project Agreement as applicable, bearing that number, including all subsidiary provisions containing that same number as a prefix.
- 2.4 Except where the context requires otherwise, references in the Output Specifications to specific Parts, Sections, Articles, Clauses, Paragraphs, Subparagraphs, Schedules, and other divisions of the Output Specifications shall be construed such that each such reference on a page of the Output Specifications will be read to be preceded by and to include the prefix Section number or other reference at the top of the applicable page, and all cross-references to any Section in Schedule 15 – Output Specifications shall be interpreted to include the applicable prefix Section number or other reference.
- 2.5 The Schedules to the Project Agreement are an integral part of the Project Agreement and a reference to the Project Agreement includes a reference to the Schedules.
- 2.6 All references in the Project Agreement to a Schedule shall be to a Schedule of the Project Agreement.
- 2.7 All capitalized terms used in a Schedule shall have the meanings given to such terms in Schedule 1, unless stated otherwise in a particular Schedule in which case such definition shall have the meaning given to it in that Schedule solely for the purposes of that Schedule.
- 2.8 The language of the Output Specifications and other documents comprising the Project Agreement is in many cases written in the imperative for brevity. Clauses containing instructions, directions or obligations are directed to Project Co and shall be construed and interpreted as if the words “Project Co shall” immediately preceded the instructions, directions or obligations.
- 2.9 Words importing persons or parties are to be broadly interpreted and include an individual, corporation, limited liability company, joint stock company, firm, partnership, joint venture, trust, unincorporated organization, Governmental Authority, unincorporated body of persons or association and any other entity having legal capacity, and the heirs, beneficiaries, executors, administrators or other legal representatives of a person in such capacity.
- 2.10 Unless the context otherwise requires, wherever used herein the plural includes the singular, the singular includes the plural, and each of the masculine, feminine and neuter genders include all other genders.
- 2.11 Unless otherwise provided in the Project Agreement, all accounting and financial terms used in the Project Agreement shall be interpreted and applied in accordance with Canadian GAAP.

- 2.12 References to any standard, principle, agreement or document include (subject to all relevant approvals and any other provisions of the Project Agreement concerning amendments) a reference to that standard, principle, agreement or document as amended, supplemented, restated, substituted, replaced, novated or assigned.
- 2.13 References to any Applicable Law, including any statutes or other Applicable Law specifically referred to herein, whether or not amendments or successors to such Applicable Law are referred to herein, are to be construed as references to that Applicable Law as from time to time amended or to any Applicable Law covering the same or similar subject matter from time to time replacing, extending, consolidating or amending the same.
- 2.14 References to a statute shall include all regulations, by-laws, ordinances and orders made under or pursuant to the statute.
- 2.15 References to persons shall include their successors and assigns. References to a public organization shall include their successors and assigns, and if a public organization ceases to exist or ceases to perform its functions without a successor or assign, references to such public organization shall be deemed to include a reference to any public organization or any organization or entity which has taken over either or both the functions and responsibilities of such public organization.
- 2.16 A reference in the Project Agreement or in any Project Document to any right, power, obligation or responsibility of any Governmental Authority shall be deemed to be a reference to the Governmental Authority that, pursuant to Applicable Laws has such right, power, obligation or responsibility at the relevant time.
- 2.17 References to a deliberate act or omission or deliberate or negligent act or omission of any Province Person shall be construed having regard to the interactive nature of the activities of the Province Person and Project Co and further having regard to:
- (a) acts contemplated by the Output Specifications; or
 - (b) acts otherwise provided for in the Project Agreement.
- 2.18 The words in the Project Agreement shall bear their natural meaning.
- 2.19 Each of Project Co's and Contracting Authority's respective obligations shall be construed as separate obligations owed to the other.
- 2.20 References containing terms such as:
- (a) "hereof", "herein", "hereto", "hereinafter", and other terms of like import are not limited in applicability to the specific provision within which such references are set forth but instead refer to the Project Agreement taken as a whole; and
 - (b) "includes" and "including", whether or not used with the words "without limitation" or "but not limited to", shall not be deemed limited by the specific enumeration of items but shall, in all cases, be deemed to be without limitation and construed and interpreted to mean "includes without limitation" and "including without limitation".

- 2.21 In construing the Project Agreement, the rule known as the *ejusdem generis* rule shall not apply nor shall any similar rule or approach apply to the construction of the Project Agreement and, accordingly, general words introduced or followed by the word “other” or “including” or “such as” or “in particular” shall not be given a restrictive meaning because they are followed or preceded (as the case may be) by particular examples intended to fall within the meaning of the general words.
- 2.22 Where the Project Agreement states that an obligation shall be performed “no later than” or “within” or “by” a stipulated date or event which is a prescribed number of days after a stipulated date or event, the latest time for performance shall be 5:00 p.m. on the last day for performance of the obligation concerned, or, if that day is not a Business Day, 5:00 p.m. on the next Business Day.
- 2.23 Where the Project Agreement states that an obligation shall be performed “no later than” or “by” a prescribed number of days before a stipulated date or event or “by” a date which is a prescribed number of days before a stipulated date or event, the latest time for performance shall be 5:00 p.m. on the last day for performance of the obligation concerned, or if that day is not a Business Day, 5:00 p.m. on the next Business Day.
- 2.24 Where the Project Agreement states that an obligation shall be performed “on” a stipulated date, the latest time for performance shall be 5:00 p.m. on that day, or, if that day is not a Business Day, 5:00 p.m. on the next Business Day.
- 2.25 Any reference to time of day or date means the local time or date in Toronto, Ontario. Any reference to a stipulated “day” which is not specifically referred to as a “Business Day” shall be deemed to be a calendar day measured from midnight to midnight.
- 2.26 Unless otherwise indicated, time periods will be strictly construed.
- 2.27 Whenever the terms “will” or “shall” are used in the Project Agreement in relation to Project Co or Contracting Authority they shall be construed and interpreted as synonymous and to read “Project Co shall” or “Contracting Authority shall” as the case may be.
- 2.28 Any reference to currency is to Canadian currency and any amount advanced, paid or calculated is to be advanced, paid or calculated in Canadian currency.
- 2.29 Unless otherwise identified in the Project Agreement, all units of measurement in any documents submitted by Project Co to Contracting Authority shall be in accordance with the SI system of units.
- 2.30 Terms not defined herein and used in the Project Agreement which have a technical meaning commonly understood by the transit system construction industry will be construed as having that meaning unless the context otherwise requires.
- 2.31 Save where expressly stated otherwise, references to amounts or sums expressed to be “indexed” or “index linked” are references to amounts or sums which require adjustment to reflect the effects of inflation. Such adjustment shall be calculated in accordance with the following formula:

$$\text{Adjusted amount or sum} = \text{Amount or sum} \times \frac{\text{CPI}_n}{\text{CPI}_o}$$

- 2.32 The terms “properly inferable”, “readily apparent” and “readily discoverable” as used in this Project Agreement, shall be interpreted by taking into consideration Project Co’s and any Project Co Party’s experience and the investigations, inspections and examinations of the Background Information and in respect of the Lands, including the Existing Infrastructure, carried out by Project Co or by any Project Co Party during the Request for Proposals process or other due diligence; and by taking into consideration reasonable, normal course and industry standard investigations, inspections or other due diligence; in each case in accordance with Good Industry Practice.

APPENDIX A

PERMITS, LICENCES, APPROVALS AND AGREEMENTS

[REDACTED].

APPENDIX B

FINAL UTILITY BASELINE DOCUMENT

[REDACTED].

APPENDIX A TO SCHEDULE 1 - PERMITS, LICENCES, APPROVALS AND AGREEMENTS

1. The Permits, Licences, Approvals and Agreements may include, but are not limited to, those included in the tables set out in this Appendix A to Schedule 1 – Permits, Licences, Approvals and Agreements (the “**PLAA Responsibility Tables**”).
2. The PLAA Responsibility Tables are for the purpose of the performance of the Works.
3. If, for any Permit, Licence, Approval or Agreement, there is a requirement under Applicable Law for the applicant to be Contracting Authority, then Project Co shall be responsible for all aspects of preparing and submitting the application on behalf of Contracting Authority at Project Co’s sole cost and expense. Project Co shall provide Contracting Authority a copy of the application. Contracting Authority may, in its sole discretion, require Project Co to submit any draft application or other materials relating to a Permit, Licence, Approval or Agreement for review by Contracting Authority in accordance with Schedule 10 – Review Procedure.
4. All other Permits, Licences, Approvals and Agreements not listed herein or otherwise noted, are the responsibility of Project Co.
5. The responsibilities listed in the PLAA Responsibility Tables below are based on and subject to the applicable requirements in respect of the Works as set out in the Project Agreement.

[REDACTED]

APPENDIX B TO SCHEDULE 1 – FINAL UTILITY BASELINE DOCUMENT

Davenport Diamond Rail Grade Separation

General Notes

- (a) Project Co is to enter into Utility Agreements with all Utility Companies in order to coordinate required work.
- (b) Project Co is to coordinate work with all Utility Companies keeping in mind potential limitations of the Utility Companies to do work in multiple locations concurrently.
- (c) Project Co is to follow all embargo and brownout periods as laid out by telecommunications companies.
- (d) Splicing for relocations is to be completed at chamber locations, either existing or new.

Table 1 – Bell Canada Utility Work

Utility Company	Description of Utility Work	Plan ID for Utility Work	Category 1 Utility Work	Duration	Cost (\$)
Bell Canada	Protection of existing Bell Canada assets in place as required	N/A	Civil design review	2 weeks	\$5000 per round of complete drawing submissions (per location) submitted by Project Co to Bell Canada for the first two rounds of submissions
			Civil inspection of Project Co’s Works related to the items set out in the column entitled “Description of Utility Work”	N/A – Bell Canada will carry out regular, on-going inspections throughout Project Co’s performance of the Utility Work.	\$5000 for all locations.

The costs and durations set out in Table 1 for the Category 1 Utility Work are based on the following assumptions:

- (a) Baseline cost and schedule estimates for the scope item "Civil design review" are per round of complete drawing submissions submitted by Project Co to Bell Canada, and are only applicable to the first two rounds of submissions. The civil design review is distinct from the review contemplated in Schedule 10 – Review Procedure;
- (b) The cost and duration information set out in Table 1 does not take into account any construction activities that may be undertaken by third parties;

- (c) Category 1 Utility Work is carried out with regard to Bell Canada’s service embargos;
- (d) Category 1 Utility Work is carried out with uninterrupted access and mobilization to Bell Canada’s infrastructure;
- (e) Category 1 Utility Work is carried out during normal working days and hours;
- (f) All costs provided are based on standard business hour rates (premium rates would apply outside of standard business hours);
- (g) All service affecting work activity or cutovers are subject to Bell Canada customer release approval and the work is to be performed during Bell Canada maintenance release window as approved by Bell Canada. The timelines for Bell Canada customer release approval are not incorporated into the durations set out in Table 1;
- (h) Bell Canada’s preference is to always minimize network/customer service impacting work and avoid where possible cable section cuts/cutovers, by supporting and maintaining existing structure 'in place', provided it is safe to do so;
- (i) Civil inspection by Bell Canada is carried out on an ongoing basis in parallel with Project Co carrying out the applicable Utility Work;
- (j) Costs do not include increases for winter work, weekend work or other work acceleration options.

The costs and durations set out in Table 1 for the Category 1 Utility Work are dependent upon Project Co carrying out the following obligations with respect to the Utility Work described in Table 1:

- (a) Project Co shall ensure that Bell Canada has uninterrupted and continuous access to Bell Canada’s infrastructure;
- (b) Any requests by Project Co to have Utility Infrastructure that is owned by more than one Utility Company to be within the same duct bank are subject to Project Co obtaining the applicable Permits, Licences, Agreements and Approvals from the applicable owners of Utility Infrastructure;
- (c) Project Co shall obtain all Permits, Licences and Approvals related to the Utility Work described in the “Description of Utility Work” column in Table 1; and
- (d) Project Co is responsible for carrying out all work related to the Utility Work described in the “Description of Utility Work” column in Table 1 that is not set out in the “Category 1 Utility Work” column.

Table 2 – Enbridge Gas Distribution Inc.

Utility Company	Description of Utility Work	Category 1 Utility Work	Duration	Cost (\$)
Enbridge Gas Distribution Inc.	Relocate gasmain crossing at Paton Road into existing abandoned pedestrian tunnel	Design	12 months	\$841,400
		Construction	5 weeks	
	Protection of existing EGD assets in place as required	Civil design review	To be determined on a site specific basis. Advanced notice of 4 weeks is required to allow for scheduling of available resources. For any documents submitted through the EGD Mark-ups group there is a targeted turn-around timeline of three (3) weeks.	Depending on the construction methodology, practices, and schedule (highlighting duration of exposure/ support), some assets may require onsite assessments/ maintenance/ monitoring/ re-coating which may have costs invoiced back.
	Civil inspection of Project Co’s Works related to the items set out in the column entitled “Description of Utility Work”	N/A – EGD will carry out regular, on-going inspections throughout Project Co’s performance of the Utility Work.		

The costs and durations set out in Table 2 for the Category 1 Utility Work are based on the following conditions and assumptions:

- (a) No design revisions from Enbridge will be requested by Project Co for any location;
- (b) Site inspection by Enbridge Gas Distribution is carried out on an ongoing basis in parallel with Project Co carrying out the applicable Utility Work as per the requirements on Enbridge Gas Distribution’s *Third Party Requirements in the Vicinity of Natural Gas Facilities*; and
- (c) Costs do not include increases for winter work, weekend work or other work acceleration options.
- (d) The estimate includes material costs, applicable overheads, taxes, restoration, but remains subject to various assumptions and conditions including but not limited to the accuracy of information provided to date, impacts of third parties, permitting, sub-surface and weather conditions, resource and land availability, network constraints and adherence of stakeholders to Enbridge’s policies and procedures. Applicable taxes are not included.
- (e) The estimate does not include time and costs associated with staging coordination between Project Co and Enbridge with respects to the partial removal of the tunnel, gas main installation, and grouting.
- (f) Enbridge has also assumed that relevant sites will be appropriately prepared for Enbridge in advance of mobilization and the grouting will be completed by Project Co.

The costs and durations set out in Table 2 for the Category 1 Utility Work are dependent upon Project Co carrying out the following obligations with respect to the Utility Work described in Table 2:

- (a) Project Co shall execute an agreement with Enbridge Gas Distribution Inc. with respect to the construction of the Utility Work;
- (b) Project Co shall ensure that Enbridge Gas Distribution Inc. has uninterrupted and continuous access to Enbridge Gas Distribution Inc.’s infrastructure;
- (c) Project Co shall obtain all Permits, Licences and Approvals related to the Utility Work described in the “Description of Utility Work” column in Table 2; and
- (d) Project Co is responsible for carrying out all work related to the Utility Work described in the “Description of Utility Work” column in Table 2 that is not set out in the “Category 1 Utility Work” column.

Preliminary designs are not acceptable and, as a guideline, designs should be not less than sixty percent (60%) complete for the designated area. In the absence of 60% design information, the following is a list of items that are necessary to be in place prior to Enbridge assessing a submitted design, and, as applicable, commencing work on a design to relocate its plant in a designated area. This list is not exclusive and additional items may be required to be provided based upon the specific design location, the existing Enbridge infrastructure that may be impacted together with Enbridge network considerations. For each of the items listed below Enbridge will determine whether the appropriate level of detail has been provided for the designated area. Note that Enbridge may require that supplemental information be submitted even in instances where a 60% design has been submitted.

- (a) Complete master land base in digital format (Microstation). All design files belonging to the project should be delivered together in a single folder. All reference files used in the design should be stored in the same directory as the master working file. Only the essential files should be included in the delivery and should be properly referenced to the master file.
- (b) Property design (proposed and existing property lines)
- (c) Grading design
- (d) Road design including planter boxes, any furnishing zones, additional decorative or functional boulevard, and road furniture
- (e) Sewer and storm design
- (f) Hydro/Utility Pole design – size of poles, alignment in relation to gas main, buried/aerial
- (g) Design for transit infrastructure
- (h) If applicable, retaining wall design, specifications, drawings, locations and construction methodology
- (i) Completed Quality Level A SUE investigation (with applicable utility company input) that has been fully integrated into design files
- (j) Complete profile cut over proposed gas main alignment
 - i. All proposed and existing municipal infrastructure (storm, sanitary, water) must have verified sizes and depths correctly reflected in profiles provided
 - ii. All data from SUE investigation on utilities must be correctly reflected in profiles provided (size, type, depth, material)
- (k) Road cross sections (as required) with the same requirements as profiles

Note: Once Enbridge begins work on the design of a specific relocation, Enbridge will not incorporate changes to Project Co's design or land base or reference files unless explicitly informed of a change that will cause a conflict with existing or proposed gas main design, construction or maintenance. In the event that a change is required, the correct updated files must be provided by Project Co and the design timelines will be reinitiated.

For pre-construction review of Enbridge assets to be protected, the following is required to be submitted through a Utility Markup Request:

- (a) Cover Letter describing the exact location and City of the proposed work.
- (b) Engineering Plans of proposed work with Directional Orientation – We require scaled pdf and CAD drawings that have the following information:
 - i. Street Names, offset dimensions to Street Lines or Property lines.
 - ii. Profile(s) with depth of proposed work if applicable; specifically at locations where proposed work crosses our gas mains.
 - iii. Cross Section(s) with depth of proposed work if applicable; specifically at locations where proposed work crosses our gas mains.
 - iv. Include Civic number if applicable
 - v. Include a Key Map showing nearest cross streets and distance from closest intersection
 - vi. Include Legend of existing and proposed structures
- (c) City sign-off sheet where applicable indicating:
 - i. Description of proposed work with method of construction
 - ii. Return contact information
- (d) Submit the required documents to Mark-Ups@enbridge.com and copy the following Enbridge Planning staff (Contact to be confirmed at outset of work)
 - i. Michael Abate michael.abate@enbridge.com
 - ii. Daniel Petrozziello daniel.petrozziello@enbridge.com

For protection of Enbridge asset during construction the following information must be provided to Enbridge for any on-site assistance or review required during execution:

- (a) Information on construction methodology, practices, and schedule including excavation area, proposed support area, protection and support plans
- (b) Any supporting/ additional information/ documentation.

For all work around EGD assets, the Third Party Requirements in the Vicinity of Natural Gas Facilities must be followed.

Note: When supporting pipelines (section 4.0) larger than NPS 8 perpendicular to an excavation (i.e. potential to occur on Antler St.), EGD must be engaged explicitly on the proposed support plans. Refer to the Appendix for contact information and copy the Enbridge Planning staff noted above. For all applicable situations it is strongly suggested to engage Enbridge on support plans as far in advance of the work as possible to limit any timeline impacts as part of reviews.

Table 3 – Toronto Hydro Electric System Limited (“THESL”)

Utility Company	Description of Utility Work	Category 1 Utility Work	Duration (weeks)	Cost (\$)	Project Co’s Obligations
THESL	Remove and replace conduit supplying under bridge lighting at Bloor Street. Temporary lighting to be supplied.	Conceptual Design Review	3	\$400,000	Project Co shall ensure that concept drawings comply with the concept checklist requirements set out in the coordination agreement between Project Co and THESL, and must be acceptable to THESL.
		Proposed Design Review	5		Project Co shall ensure that detailed drawings comply with the concept checklist requirements set out in the coordination agreement between Project Co and THESL, and must be acceptable to THESL.
		Permit Design Review	3		Project Co shall ensure that permit drawings comply with the concept checklist requirements set out in the coordination agreement between Project Co and THESL, and must be acceptable to THESL.
		Approved for Construction Review	5		Project Co shall ensure that construction drawings comply with the concept checklist requirements set out in the coordination agreement between Project Co and THESL, and must be acceptable to THESL.

	Order To Operate Request	2	<p>Project Co must submit a schedule of work and an official Order To Operate request for feeder switching two weeks in advance of the commencement of Works in this specific area.</p> <p>Upon the approval of an Order To Operate, THESL will require 0.5 days is for switching feeders on the scheduled date. Feeder switching is a two-step process requiring (outage and restoration).</p> <ul style="list-style-type: none"> • System switching restrictions: <ul style="list-style-type: none"> ○ Summer switching restrictions may apply and are subject to change. ○ Outage is limited to one feeder per group of interconnected feeders. Within a group of interconnected feeders, a feeder must be restored prior to any other subsequent feeder outages. <p>THESL determines the system condition and identifies the interconnected feeders.</p>
Temporarily/permanently relocate high voltage cables in Bloor Street north sidewalk (including UG feed to billboard). New cable to be installed within limits of relocation.	Conceptual Design Review	3	Project Co shall ensure that concept drawings comply with the concept checklist requirements set out in the coordination agreement between Project Co and THESL, and must be acceptable to THESL.
	Proposed Design Review	5	Project Co shall ensure that detailed drawings comply with the concept checklist requirements set out in the coordination agreement between Project Co and THESL, and must be acceptable to THESL.
	Permit Design Review	3	Project Co shall ensure that permit drawings comply with the concept checklist requirements set out in the coordination agreement between Project Co and THESL, and must be acceptable to THESL.
	Approved for Construction Review	5	Project Co shall ensure that construction drawings comply with the concept checklist requirements set out in the coordination agreement between Project Co and THESL, and must be acceptable to THESL.

	Order To Operate Request	2	<p>Project Co must submit a schedule of work and an official Order To Operate request for feeder switching two weeks in advance of the commencement of Works in this specific area.</p> <p>Upon the approval of an Order To Operate, THESL will require 0.5 days is for switching feeders on the scheduled date. Feeder switching is a two-step process requiring (outage and restoration).</p> <ul style="list-style-type: none"> • System switching restrictions: <ul style="list-style-type: none"> ○ Summer switching restrictions may apply and are subject to change. ○ Outage is limited to one feeder per group of interconnected feeders. Within a group of interconnected feeders, a feeder must be restored prior to any other subsequent feeder outages. <p>THESL determines the system condition and identifies the interconnected feeders.</p>
Reinstate into new 4x6 concrete ductbanks in north and south sidewalks of Bloor Street.	Conceptual Design Review	3	Project Co shall ensure that concept drawings comply with the concept checklist requirements set out in the coordination agreement between Project Co and THESL, and must be acceptable to THESL.
	Proposed Design Review	5	Project Co shall ensure that detailed drawings comply with the concept checklist requirements set out in the coordination agreement between Project Co and THESL, and must be acceptable to THESL.
	Permit Design Review	3	Project Co shall ensure that permit drawings comply with the concept checklist requirements set out in the coordination agreement between Project Co and THESL, and must be acceptable to THESL.

	Approved for Construction Review	5	Project Co shall ensure that construction drawings comply with the concept checklist requirements set out in the coordination agreement between Project Co and THESL, and must be acceptable to THESL.	
	Order To Operate Request	2	<p>Project Co must submit a schedule of work and an official Order To Operate request for feeder switching two weeks in advance of the commencement of Works in this specific area.</p> <p>Upon the approval of an Order To Operate, THESL will require 0.5 days is for switching feeders on the scheduled date. Feeder switching is a two-step process requiring (outage and restoration).</p> <ul style="list-style-type: none"> • System switching restrictions: <ul style="list-style-type: none"> ○ Summer switching restrictions may apply and are subject to change. ○ Outage is limited to one feeder per group of interconnected feeders. Within a group of interconnected feeders, a feeder must be restored prior to any other subsequent feeder outages. <p>THESL determines the system condition and identifies the interconnected feeders.</p>	
	Relocate or remove guy wire crossing at Paton Road	Conceptual Design Review	3	Project Co shall ensure that concept drawings comply with the concept checklist requirements set out in the coordination agreement between Project Co and THESL, and must be acceptable to THESL.
		Proposed Design Review	5	Project Co shall ensure that detailed drawings comply with the concept checklist requirements set out in the coordination agreement between Project Co and THESL, and must be acceptable to THESL.
Permit Design Review		3	Project Co shall ensure that permit drawings comply with the concept checklist requirements set out in the coordination agreement between Project Co and THESL, and must be acceptable to THESL.	

	Approved for Construction Review	5
	Order To Operate Request	2
	Conceptual Design Review	3
	Proposed Design Review	5
Relocate ductbank running beneath Paton Road to allow for construction of MSE wall.	Permit Design Review	3

Project Co shall ensure that construction drawings comply with the concept checklist requirements set out in the coordination agreement between Project Co and THESL, and must be acceptable to THESL.
<p>Project Co must submit a schedule of work and an official Order To Operate request for feeder switching two weeks in advance of the commencement of Works in this specific area.</p> <p>Upon the approval of an Order To Operate, THESL will require 0.5 days is for switching feeders on the scheduled date. Feeder switching is a two-step process requiring (outage and restoration).</p> <ul style="list-style-type: none"> • System switching restrictions: <ul style="list-style-type: none"> ○ Summer switching restrictions may apply and are subject to change. ○ Outage is limited to one feeder per group of interconnected feeders. Within a group of interconnected feeders, a feeder must be restored prior to any other subsequent feeder outages. <p>THESL determines the system condition and identifies the interconnected feeders.</p>
Project Co shall ensure that concept drawings comply with the concept checklist requirements set out in the coordination agreement between Project Co and THESL, and must be acceptable to THESL.
Project Co shall ensure that detailed drawings comply with the concept checklist requirements set out in the coordination agreement between Project Co and THESL, and must be acceptable to THESL.
Project Co shall ensure that permit drawings comply with the concept checklist requirements set out in the coordination agreement between Project Co and THESL, and must be acceptable to THESL.

	Approved for Construction Review	5	<p>Project Co shall ensure that construction drawings comply with the concept checklist requirements set out in the coordination agreement between Project Co and THESL, and must be acceptable to THESL.</p> <p>Project Co must submit a schedule of work and an official Order To Operate request for feeder switching two weeks in advance of the commencement of Works in this specific area.</p> <p>Upon the approval of an Order To Operate, THESL will require 0.5 days is for switching feeders on the scheduled date. Feeder switching is a two-step process requiring (outage and restoration).</p> <ul style="list-style-type: none"> • System switching restrictions: <ul style="list-style-type: none"> ○ Summer switching restrictions may apply and are subject to change. ○ Outage is limited to one feeder per group of interconnected feeders. Within a group of interconnected feeders, a feeder must be restored prior to any other subsequent feeder outages. <p>THESL determines the system condition and identifies the interconnected feeders.</p>
	Order To Operate Request	2	
Relocate overhead crossing at Wallace Avenue	Conceptual Design Review	3	Project Co shall ensure that concept drawings comply with the concept checklist requirements set out in the coordination agreement between Project Co and THESL, and must be acceptable to THESL.
	Proposed Design Review	5	Project Co shall ensure that detailed drawings comply with the concept checklist requirements set out in the coordination agreement between Project Co and THESL, and must be acceptable to THESL.
	Permit Design Review	3	Project Co shall ensure that permit drawings comply with the concept checklist requirements set out in the coordination agreement between Project Co and THESL, and must be acceptable to THESL.

	Approved for Construction Review	5	<p>Project Co shall ensure that construction drawings comply with the concept checklist requirements set out in the coordination agreement between Project Co and THESL, and must be acceptable to THESL.</p> <p>Project Co must submit a schedule of work and an official Order To Operate request for feeder switching two weeks in advance of the commencement of Works in this specific area.</p> <p>Upon the approval of an Order To Operate, THESL will require 0.5 days is for switching feeders on the scheduled date. Feeder switching is a two-step process requiring (outage and restoration).</p> <ul style="list-style-type: none"> • System switching restrictions: <ul style="list-style-type: none"> ○ Summer switching restrictions may apply and are subject to change. ○ Outage is limited to one feeder per group of interconnected feeders. Within a group of interconnected feeders, a feeder must be restored prior to any other subsequent feeder outages. <p>THESL determines the system condition and identifies the interconnected feeders.</p>
	Order To Operate Request	2	
	Conceptual Design Review	3	
	Proposed Design Review	5	
Abandonment of existing THESL empty ductbank and associated chamber, south of Davenport Road.	Permit Design Review	3	<p>Project Co shall ensure that concept drawings comply with the concept checklist requirements set out in the coordination agreement between Project Co and THESL, and must be acceptable to THESL.</p> <p>Project Co shall ensure that detailed drawings comply with the concept checklist requirements set out in the coordination agreement between Project Co and THESL, and must be acceptable to THESL.</p> <p>Project Co shall ensure that permit drawings comply with the concept checklist requirements set out in the coordination agreement between Project Co and THESL, and must be acceptable to THESL.</p>

		Approved for Construction Review	5		Project Co shall ensure that construction drawings comply with the concept checklist requirements set out in the coordination agreement between Project Co and THESL, and must be acceptable to THESL.
		Civil inspection of Project Co's Works related to the items set out in the column entitled "Description of Utility Work"	N/A		
	Offer to Connect work to supply the 3 Phase 150KVA padmount transformer at Antler Street	Deliver supply to padmount transformer and connect to existing power grid as per the THESL website.	As per the THESL website.	\$100,000	Project Co shall be responsible for all civil works within the Metrolinx corridor, including the concrete pad for the required padmount transformer at Antler Street.

In addition to the Project Co obligations set out in Table 3, the costs and durations set out in Table 3 for the Category 1 Utility Work are dependent upon the following assumptions and upon Project Co carrying out the following obligations with respect to the Utility Work described in Table 3:

- (a) Design of relocation and protection of THESL assets to be conducted by THESL approved contractor retained by Project Co.
- (b) With respect to the costs and durations set out in Table 3, THESL has provided baseline costs and durations for self-performed activities from the documents and drawings submitted. This does not imply that designs submitted have been reviewed or approved;
- (c) With respect to the THESL design review process,
 - (i) Project Co must submit drawings that comply with THESL design expectations;
 - (ii) THESL will make efforts to accommodate additional submissions and Project Co shall submit drawings for review as and when they are complete; and
 - (iii) Project Co's submission of one stage of drawings does not guarantee movement to next stage. If THESL requires Project Co to resubmit a stage of drawings, the review time of 14 or 24 business days will begin from the date of the resubmission.
 - (iv) The review periods described in Table 3 are dependent upon one design being submitted at a time. Review period may be extended if concurrent review of multiple locations is required.
- (d) With respect to THESL inspections,

- (i) THESL will engage in on-going inspections during Project Co’s performance of the Utility Work, and these inspections are not expected to add any time to the durations or costs to Project Co to the durations and costs Table 3;
 - (ii) Typically, inspections are once a day per site during construction, but during certain critical tasks continuous monitoring may occur. “Critical tasks” include concrete pouring for duct banks, vaults/chamber builds, supporting in place activities, and similar activities. Project Co shall notify THESL of critical construction tasks at least two weeks in advance; and
 - (iii) Project Co shall notify THESL at least two weeks in advance for final inspections to be completed by THESL.
- (e) With respect to Project Co’s scheduling of the Utility Work described in Table 3,
- (i) THESL will require sufficient notification of planned activities for scheduling and resource allocation. If given sufficient notice of a high level plan, THESL can schedule other construction activities around Project Co’s plan;
 - (ii) THESL will need to ensure that inspection resources are available for all the planned activities. Therefore, Project Co shall submit the following schedules to THESL in accordance with the following:
 - (A) a quarterly schedule indicating switching and construction activities for the next 12 months, updated beginning of every quarter;
 - (B) a monthly schedule indicating switching and construction activities for the next 3 months, updated beginning of every month; and
 - (C) to minimize scheduling delays, a switching schedule indicating the location, feeder affected, schedule date, duration of outage expected, and activity description;
 - (iii) Project Co shall notify THESL of critical construction tasks at least two weeks in advance; and
 - (iv) Project Co shall notify THESL when changes to the schedule are made.
- (f) With respect to outage and switching, the following restrictions apply:
- (v) For all other feeders: outage is limited to one feeder per group of interconnected feeders. Within a group of interconnected feeders, a feeder must be restored prior to any other subsequent feeder outages.;
 - (vi) Switching is a two-step process which involves feeder outage and feeder restoration;
 - (vii) Project Co shall plan the Works to minimize switching of any feeders;
 - (viii) Project Co shall minimize outage duration of a feeder where possible;
 - (ix) Project Co shall submit an official Order To Operate request two weeks in advance for all other feeder switching. Hold off is required 1 day in advance;
 - (x) Order To Operate requests are not guaranteed and scheduling is subject to change due to THESL planned capital projects, maintenance, switching restrictions, key account customer restrictions and emergencies. To minimize scheduling delays, switching schedule indicating the location, feeder affected, schedule date, duration of outage expected, and activity description must be provided by Project Co; and

- (xi) In the event of an emergency, THESL may modify switching schedules and temporarily limit access to the distribution system due to safety;
- (g) Project Co shall obtain all Permits, Licences and Approvals related to the Utility Work described in the “Description of Utility Work” column in Table 3; and
- (h) Project Co is responsible for carrying out all work related to the Utility Work described in the “Description of Utility Work” column in Table 3 that is not set out in the “Category 1 Utility Work” column.

Table 4 – Rogers Communications Partnership

Utility Company	Description of Utility Work	Category 1 Utility Work	Duration	Cost (\$)	Comments, Dependencies, etc.
Rogers Communications Partnership	Relocate existing Rogers pedestal at 258 Wallace Avenue approximately 3m west inside the existing bollards	Engineering design and permits	6 months	\$15,000 + \$15% admin fee.	To proceed with pedestal relocation, Rogers will require a letter from requestor and purchase order for value noted. Note that additional purchase order may be required based on permits fee
		Construction	2 months		
	Protection of existing Rogers assets in place as required.	Civil design review	1-2 weeks	\$5000 per location	Review duration pending project scope
		Civil inspection of Project Co’s Works related to the items set out in the column entitled “Description of Utility Work”	Minimum 4 hours per visit	\$250/hr per technician	These inspections may be on-Site inspections, as determined by Rogers Communications Partnership.

The costs and durations set out in Table 4 for the Category 1 Utility Work are based on the following conditions and assumptions:

- (a) Costs do not include increases for winter work, weekend work or other work acceleration options.
- (b) Relocation of the existing pedestal will be done by Rogers authorized construction contractor under direct supervision of Rogers NCC technician.

The costs and durations set out in Table 4 for the Category 1 Utility Work are dependent upon Project Co carrying out the following obligations with respect to the Utility Work described in Table 4:

- (a) Project Co shall ensure that Rogers Communications Partnership has uninterrupted and continuous access to Rogers Communications Partnership’s infrastructure;
- (b) Project Co shall obtain all Permits, Licences and Approvals related to the Utility Work described in the “Description of Utility Work” column in Table 4; and
- (c) Project Co is responsible for carrying out all work related to the Utility Work described in the “Description of Utility Work” column in Table 4 that is not set out in the “Category 1 Utility Work” column.

Table 5 – Bell 360

Utility Company	Description of Utility Work	Category 1 Utility Work	Duration	Cost (\$)
Bell 360	Protection of existing Bell 360 telecom assets in place as required at CP rail corridor.	Civil design review	2 weeks	\$2,720
		Coordination for installation (locates, material acquisition, identifying contractor, etc.)	8 weeks	\$4,080
		Installation of protection	2 weeks	\$40,000
		Civil inspection of Project Co’s Works related to the items set out in the column entitled “Description of Utility Work”	Assumed 2 weeks – Bell 360 requires an inspector to be on site during all works within 2m of Bell 360 assets. 2 weeks advance notice required for Bell 360 inspector availability	\$9,280

The costs and durations set out in Table 4 for the Category 1 Utility Work are based on the following conditions and assumptions:

- (a) Costs do not include increases for winter work, weekend work or other work acceleration options.
- (b) Project Co shall follow all Bell 360 brown out and embargo periods.
 - a. The Brown out period means zero work within the two (2) meter mark of network until Brown out period is over with no exceptions.
 - b. The Embargo period means that work can occur within the two (2) meter mark around network but will need Bell approval to do so, if there is a great risk to the network in the work plan then approval will be denied until Embargo/Brown out period is over. If approval is granted to proceed with the work Bell/LTS rep must be present at all times to monitor site.
 - c. Embargo dates for 2018 (typically similar every year) are as follows:
 - i. Black Friday/Cyber Monday Embargo between November 22, 2018 and November 30, 2018.
 - ii. Holiday Embargo between December 1, 2018 and December 15, 2018.
 - iii. High Sales Embargo between December 15, 2018 and December 31, 2018.
 - iv. Holiday Brownout between December 15, 2018 and January 3, 2019.
 - v. Bell TV Brownout between December 19, 2018 and January 2, 2019.

The costs and durations set out in Table 5 for the Category 1 Utility Work are dependent upon Project Co carrying out the following obligations with respect to the Utility Work described in Table 5:

- (a) The above timeframes are based discussion of only approximately 40m of network protection works by typical excavation/installations. It does not take into account any other cables in proximity of the Bell 360 network resulting in hydrovac works to perform excavations, which would take longer to perform works.
- (b) The above review timeframe is based on a submission to Bell 360, including relevant information near Bell 360 assets. Provision of extraneous information will result in longer review times
- (c) Project Co shall confirm ownership of all telecommunications infrastructure located within the Rail Corridor;
- (d) Project Co shall ensure that Bell 360 has uninterrupted and continuous access to Bell 360's infrastructure;
- (e) Project Co shall obtain all Permits, Licences and Approvals related to the Utility Work described in the "Description of Utility Work" column in Table 5; and
- (f) Project Co is responsible for carrying out all work related to the Utility Work described in the "Description of Utility Work" column in Table 5 that is not set out in the "Category 1 Utility Work" column.

Table 6 – Toronto Transit Commission (“TTC”)

Utility Company	Description of Utility Work	Category 1 Utility Work	Duration (weeks)	Cost (\$)	Project Co’s Obligations
TTC	Relocate existing 600V DC cable from north sidewalk at Bloor Street into new THES structure in south sidewalk. New cable to be installed within limits of relocation.	Conceptual Design Review	3	\$9,000	Project Co shall ensure that concept drawings comply with the requirements set out in the coordination agreement between ProjectCo and TTC and must be acceptable to TTC.
		Proposed Design Review	5		Project Co shall ensure that detailed drawings comply with the requirements set out in the coordination agreement between ProjectCo and TTC and must be acceptable to TTC.
		Permit Design Review	3		Project Co shall ensure that permit drawings comply with the concept checklist requirements set out in the coordination agreement between Project Co and THES, and must be acceptable to THES. Project Co shall ensure the duct allocated to TTC cable is acceptable.
		Approved for Construction Review	5		Project Co shall ensure that construction drawings comply with the requirements set out in the coordination agreement between ProjectCo and TTC and must be acceptable to TTC.
		Cable Splicing	2		Project Co must submit a schedule of work and appropriate notice to request feeder switching in advance of the commencement of Works in this specific area.

The costs and durations set out in Table 6 for the Category 1 Utility Work are based on the following conditions and assumptions:

- (a) Costs do not include increases for winter work, weekend work or other work acceleration options (excluding overnight cable works).
- (b) The cost provided in Table 6 includes TTC overhead costs for the work.

In addition to the Project Co obligations set out in Table 6, the costs and durations set out in Table 6 for the Category 1 Utility Work are dependent upon the following assumptions and upon Project Co carrying out the following obligations with respect to the Utility Work described in Table 6:

- (a) Design of relocation and protection of TTC assets to be conducted by THES approved contractor retained by Project Co.
- (b) With respect to the costs and durations set out in Table 6, TTC has provided baseline costs and durations for self-performed activities from the documents and drawings submitted. This does not imply that designs submitted have been reviewed or approved;
- (c) With respect to the TTC design review process,
 - (i) Project Co must submit drawings that comply with TTC design expectations;

- (ii) TTC will make efforts to accommodate additional submissions and Project Co shall submit drawings for review as and when they are complete; and
 - (iii) Project Co's submission of one stage of drawings does not guarantee movement to next stage. If TTC requires Project Co to resubmit a stage of drawings, the review time will begin from the date of the resubmission.
 - (iv) The review periods described in Table 6 are dependent upon one design being submitted at a time. Review period may be extended if concurrent review of multiple locations is required.
- (d) With respect to TTC inspections,
- (i) TTC will engage in on-going inspections during Project Co's performance of the Utility Work, and these inspections are not expected to add any time to the durations or costs to Project Co to the durations and costs Table 6;
 - (ii) Typically, inspections are once a day per site during construction, but during certain critical tasks continuous monitoring may occur. "Critical tasks" include concrete pouring for duct banks, vaults/chamber builds, supporting in place activities, and similar activities. Project Co shall notify TTC of critical construction tasks at least two weeks in advance; and
 - (iii) Project Co shall notify TTC at least two weeks in advance for final inspections to be completed by TTC.
- (e) With respect to Project Co's scheduling of the Utility Work described in Table 6,
- (i) TTC will require sufficient notification of planned activities for scheduling and resource allocation. If given sufficient notice of a high-level plan, TTC can schedule other construction activities around Project Co's plan;
 - (ii) TTC will need to ensure that inspection resources are available for all the planned activities. Therefore, Project Co shall submit the following schedules to TTC in accordance with the following:
 - (A) a quarterly schedule indicating switching and construction activities for the next 12 months, updated beginning of every quarter;
 - (B) a monthly schedule indicating switching and construction activities for the next 3 months, updated beginning of every month; and
 - (C) to minimize scheduling delays, a switching schedule indicating the location, feeder affected, schedule date, duration of outage expected, and activity description;
 - (iii) Project Co shall notify TTC of critical construction tasks at least two weeks in advance; and
 - (iv) Project Co shall notify TTC when changes to the schedule are made.
- (f) With respect to outage and switching, the following restrictions apply:
- (i) For all other feeders: outage is limited to one feeder per group of interconnected feeders. Within a group of interconnected feeders, a feeder must be restored prior to any other subsequent feeder outages.;
 - (ii) Switching is a two-step process which involves feeder outage and feeder restoration;
 - (iii) Project Co shall plan the Works to minimize switching of any feeders;

- (iv) Project Co shall minimize outage duration of a feeder where possible; and
- (v) Project Co shall submit a copy of the THESL Order To Operate request to TTC two weeks in advance for all feeder switching (refer to Table 3 above). Note: Order To Operate requests are not guaranteed and scheduling is subject to change due to THESL planned capital projects, maintenance, switching restrictions, key account customer restrictions and emergencies. To minimize scheduling delays, switching schedule indicating the location, feeder affected, schedule date, duration of outage expected, and activity description must be provided by Project Co.
- (g) Project Co shall obtain all Permits, Licences and Approvals related to the Utility Work described in the “Description of Utility Work” column in Table 6; and
- (h) Project Co is responsible for carrying out all work related to the Utility Work described in the “Description of Utility Work” column in Table 6 that is not set out in the “Category 1 Utility Work” column.

**SCHEDULE 2
COMPLETION DOCUMENTS**

In this Schedule 2, “certified” shall mean that the relevant document is certified as a true and complete copy in full force and effect and unamended as of the date of the relevant certificate by an officer or director of the relevant corporation.

1. DOCUMENTS TO BE DELIVERED BY PROJECT CO

Unless an original document is specifically required, a certified copy of each of the following documents (in each case, executed by the parties to such agreement other than Contracting Authority and in form and substance satisfactory to Contracting Authority, acting reasonably) is to be delivered by Project Co to Contracting Authority on or prior to the Financial Close Target Date:

- 1.1 an original of the Project Agreement;
- 1.2 an original of the Lenders’ Direct Agreement;
- 1.3 an original of the Independent Certifier Agreement;
- 1.4 an original of the Insurance Trust Agreement;
- 1.5 an original Notice of appointment of the Project Co Representative;
- 1.6 the Lending Agreements;
- 1.7 the Design and Construction Contract;
- 1.8 an original of the Performance Guarantee of Construction Guarantor;
- 1.9 an original of the Construction Contractor’s Direct Agreement;
- 1.10 a certificate of insurance and draft policies of insurance for the insurances required to be taken out by Project Co in accordance with the Project Agreement;
- 1.11 one printed copy of the Financial Model and two copies on CD-ROM;
- 1.12 the Interim Baseline Works Schedule in accordance with the requirements set out in Schedule 12 – Works Schedule Requirements;
- 1.13 original Bonds required in accordance with the Project Agreement or as Contracting Authority may direct in accordance with the Insurance Trust Agreement;
- 1.14 an original of the undertaking and acknowledgment in the form attached as Appendix A to this Schedule 2;
- 1.15 a certificate of an officer of Project Co substantially in the form attached as Appendix B to this Schedule 2;

- 1.16 a certificate of an officer of the Construction Contractor substantially in the form attached as Appendix B to this Schedule 2;
- 1.17 a certificate of an officer of the Construction Guarantor substantially in the form attached as Appendix B to this Schedule 2;
- 1.18 an original of the opinion from counsel to Project Co, the Construction Contractor, the Construction Guarantor, and such other Project Co Parties as Contracting Authority may reasonably require substantially in the form attached as Appendix C to this Schedule 2 and otherwise acceptable to Contracting Authority and its counsel;
- 1.19 evidence that the COR-Certified Construction Project Co Party has its COR Certification in good standing (or to the extent that the COR-Qualified Construction Project Co Party does not have its COR Certification by Financial Close, evidence that the COR-Qualified Construction Project Co Party has its current OHSAS 18001 Accreditation in good standing and has made an application to IHSA for its COR Certification);
- 1.20 in respect of the Construction Contractor (and where the Construction Contractor is a partnership or joint venture, in respect of each partner of the partnership or member of the joint venture, as applicable), a WSIB clearance certificate, or if a WSIB clearance certificate is not available, equivalent documentation from another jurisdiction, current to the date of Commercial Close;
- 1.21 in respect of the Construction Contractor (and where the Construction Contractor is a partnership or joint venture, in respect of each partner of the partnership or member of the joint venture, as applicable), a CAD-7, or, if a CAD-7 is not available, equivalent documentation from another jurisdiction, current to the date of Commercial Close;
- 1.22 in respect of the Construction Contractor (and where the Construction Contractor is a partnership or joint venture, in respect of each partner of the partnership or member of the joint venture, as applicable), a Workplace Injury Summary Report (WISR) or, if a WSIR is not available, equivalent documentation from another jurisdiction, current to the date of Commercial Close;
- 1.23 [Intentionally Deleted];
- 1.24 an original of the Construction Safety Management Plan; and
- 1.25 such other documents as the Parties may agree, each acting reasonably.

2. DOCUMENTS TO BE DELIVERED BY CONTRACTING AUTHORITY

Unless an original document is specifically required, a certified copy of each of the following documents (in each case, where IO or Metrolinx is a party to such document, executed by IO or Metrolinx and, if applicable, any Contracting Authority Party or Governmental Authority) is to be delivered by Contracting Authority to Project Co on or prior to the Financial Close Target Date:

- 2.1 an original of the Project Agreement;
- 2.2 an original of the Lenders' Direct Agreement;
- 2.3 an original of the Construction Contractor's Direct Agreement;

- 2.4 an original of the Independent Certifier Agreement;
- 2.5 an original of the Insurance Trust Agreement;
- 2.6 an original Notice of appointment of the Contracting Authority Representative;
- 2.7 a certificate of an officer of IO and a declaration of management signed by an officer of IO substantially in the forms attached as Appendix D-1 and Appendix E respectively to this Schedule 2;
- 2.8 a certificate of an officer of Metrolinx signed by an officer of Metrolinx substantially in the form attached as Appendix D-2 to this Schedule 2; and
- 2.9 such other documents as the Parties may agree, each acting reasonably.

APPENDIX A

FORM OF UNDERTAKING AND ACKNOWLEDGEMENT

- TO:** ONTARIO INFRASTRUCTURE AND LANDS CORPORATION, a Crown agent, continued under the *Ontario Infrastructure and Lands Corporation Act, 2011* (“IO”)
- TO:** METROLINX, a non-share capital corporation continued under the *Metrolinx Act, 2006*, S.O. 2006, c. 16 and a Crown agency in accordance with the *Crown Agency Act, R.S.O. 1990, c. 48* (“Metrolinx”) collectively, (“CONTRACTING AUTHORITY”)
- AND TO:** The Minister of Infrastructure (the “Minister”)
- RE:** Project agreement (as amended, supplemented or modified from time to time, the “Project Agreement”) dated the ■ day of ■, 2019 between Contracting Authority and GCRS Davenport General Partnership (“Project Co”)
-

1. The undersigned acknowledges that:
 - (a) The Project will proceed as an alternative financing and procurement project under the MOI’s *ReNew Ontario* infrastructure investment plan, and complies with the principles which guide the financing and procurement of public infrastructure projects in Ontario.
 - (b) The five fundamental principles which guide the financing and procurement of public infrastructure projects in Ontario:
 - (i) The public interest is paramount.
 - (ii) Value for money must be demonstrable.
 - (iii) Appropriate public control/ownership must be preserved.
 - (iv) Accountability must be maintained.
 - (v) All processes must be fair, transparent and efficient.
 - (c) Consistent with the principle of appropriate public ownership/control, public ownership of assets will be preserved in the public sector.
2. Capitalized terms used but not defined herein have the respective meanings ascribed thereto in the Project Agreement.

[SIGNATURE PAGE IMMEDIATELY FOLLOWS]

DATED this ____ day of _____, 20[•].

GCRS DAVENPORT GENERAL PARTNERSHIP,
by its partners:

GCP DAVENPORT INC.

Per: _____
Name:
Title:

I have authority to bind the corporation.

GRACORP DAVENPORT INC.

Per: _____
Name:
Title:

I have authority to bind the corporation.

APPENDIX B
FORM OF PROJECT CO/PROJECT CO PARTY OFFICER’S CERTIFICATE

Certificate of an Officer of

■

(the “Corporation”)

in its own capacity and in its capacity as partner of

GCRS DAVENPORT GENERAL PARTNERSHIP

(“Project Co”)

TO: HER MAJESTY THE QUEEN IN RIGHT OF ONTARIO

AND TO: ONTARIO INFRASTRUCTURE AND LANDS CORPORATION AND METROLINX (collectively, “Contracting Authority”)

AND TO: THE MINISTER OF INFRASTRUCTURE

I, ■, being the ■ of the Corporation and an authorized signatory of the Corporation and being duly authorized by the Corporation to deliver this certificate, hereby make the following certifications and confirmations for and on behalf of the Corporation, in its own capacity and in its capacity as a general partner of Project Co, and without incurring personal liability and that the same may be relied upon by you without further inquiry:

1. **Constituting Documents**

- (a) The Corporation is a subsisting corporation duly incorporated under the laws of the [REDACTED].
- (b) Project Co is a subsisting general partnership under the laws of the Province of Ontario. As of the date hereof, the Corporation and [insert name of other partner of Project Co] are the only partners of Project Co.
- (c) Attached hereto as **Schedule “A”** are true and complete copies of the certificate of incorporation and articles, together with all amendments thereto, of the Corporation (the **“Articles”**). The Articles are in full force and effect on the date hereof and no other articles have been issued and no proceeding has been taken or is contemplated to the date hereof to authorize the Corporation to amend, surrender or cancel the Articles.
- (d) Attached hereto as **Schedule “B”** are true and complete copies of the by-laws of the Corporation (the **“By-laws”**) enacted on or before the date hereof. The By-laws have been in full force and effect from and after the date thereof as set out therein and are in full force

and effect, unamended as of the date hereof. No proceeding has been taken to the date hereof to authorize the Corporation to amend the By-laws and neither the directors nor the shareholders of the Corporation have passed, confirmed or consented to any resolutions amending or varying the By-laws.

- (e) **[Attached hereto as Schedule “C” is a true and complete copy of a unanimous shareholders’ agreement between the shareholders of the Corporation and the Corporation (the “Unanimous Shareholders’ Agreement”) executed on or before the date hereof. The Unanimous Shareholders’ Agreement has been in full force and effect from and after the date thereof as set out therein and is in full force and effect, unamended as of the date hereof.] OR [The Corporation is not party to, and nor is it bound or affected by, any unanimous shareholders’ agreement or declaration of shareholders which restricts the powers of the directors of the Corporation to manage the business and affairs of the Corporation.]**
- (f) A business name registration for Project Co (the “**Project Co Registration**”) in the prescribed form has been filed with the Ministry of Government Services (Ontario) in accordance with the provisions of the Business Names Act (Ontario) (the “**Act**”) and has not expired. A complete copy of the Project Co Registration is attached as Schedule [“**■**”]. The Project Co Registration is true and correct in all respects, is and remains in full force and effect and no registration of change has been filed. The Project Co Registration has not been amended, supplemented, surrendered or cancelled, and no proceedings have been taken or are pending to amend, supplement, surrender or cancel it.
- (g) Attached hereto as Schedule [“**■**”] is a true and complete copy of the partnership agreement between the Corporation and [insert name of other partner] (the “**Project Co Partnership Agreement**”). The Project Co Partnership Agreement is and remains in full force and effect and has not been amended, restated, replaced, supplemented or cancelled as of the date hereof and no proceeding has been taken or is contemplated to amend, restate, replace, supplement or cancel it. The Project Co Partnership Agreement is the only agreement between the Corporation and [insert name of other partner] which relates or pertains in any way to their relationship as partners of Project Co.
- (h) As of the date hereof, Project Co exists as a general partnership under the *Partnerships Act* (Ontario), and no step or proceeding has been taken or resolutions passed, or are contemplated to be taken or passed, with respect to the dissolution, liquidation or termination of Project Co, and no events have occurred which would permit or require any of the partners in Project Co to dissolve, liquidate or terminate Project Co.
- (i) The minute books and corporate records of the Corporation made available to Fasken Martineau DuMoulin LLP are the original minute books and corporate records of the Corporation and contain all minutes of meetings, resolutions and proceedings of the shareholders and directors of the Corporation to the date hereof and there have been no meetings, resolutions or proceedings authorized or passed by the shareholders or directors of the Corporation to the date hereof not reflected in such minute books and corporate records. Such minute books and corporate records are true, complete and correct in all material respects and there are no changes, additions or alterations necessary to be made thereto to make such minute books and corporate records true, complete and correct in all material respects.

- (j) The partnership records of Project Co made available to Fasken Martineau DuMoulin LLP are true, complete and correct, are the original partnership records of Project Co and contain all minutes of meetings, resolutions and proceedings of the partners (including any committees thereof) to the date hereof and there have been no meetings, resolutions or proceedings authorized or passed by the partners of Project Co to the date hereof not reflected in such partnership records.
- (k) At the date hereof, no winding-up, liquidation, dissolution, insolvency, bankruptcy, amalgamation, arrangement, reorganization or continuation proceedings in respect of the Corporation or Project Co have been commenced or are being contemplated by the Corporation or Project Co, and neither the Corporation nor Project Co has any knowledge of any such proceedings having been commenced or contemplated in respect of the Corporation or Project Co by any other party.
- (l) At the date hereof, the Corporation and Project Co are up-to-date in the filing of all returns and other documents required to be filed by them by governmental authorities, including under corporate, partnership, securities and tax legislation, no notice of any proceedings or other communication from any third party to cancel the Corporation's certificate of incorporation or otherwise to terminate the existence of the Corporation or Project Co has been received by the Corporation or Project Co, and neither the Corporation nor Project Co has taken any steps to terminate or change its existence as a corporation or general partnership, as applicable, since its date of corporation or formation, as applicable.
- (m) **[Pursuant to the Unanimous Shareholders' Agreement, the powers of the directors of the Corporation to manage the business and affairs of the Corporation, whether such powers arise from the *Business Corporations Act (Ontario)* (the "Act"), the Articles or the By-laws of the Corporation, or otherwise, are restricted to the fullest extent permitted by law, and, in accordance with the Act and the Unanimous Shareholders' Agreement, the shareholders of the Corporation have and enjoy and may exercise and perform all the rights, powers, and duties of the directors of the Corporation to manage the business and affairs of the Corporation.]**
- (n) There are no provisions in the Articles, By-laws, Project Co Partnership Agreement [, **Unanimous Shareholders' Agreement**] or in any other agreement binding on the Corporation or Project Co which:
- (i) restrict or limit the powers of the Corporation to enter into, in its own capacity or in its capacity as a partner of Project Co, as applicable:
 - (1) a certain project agreement with Contracting Authority made as of ■, 2019 (as the same may be amended, supplemented, restated or otherwise modified from time to time, the "**Project Agreement**") pursuant to which the Corporation will design, build and finance the New Metrolinx Infrastructure and the New Third Party Infrastructure;
 - (2) a lenders' direct agreement between the Corporation, Contracting Authority and the Lenders' Agent;

- (3) a design and construction contract between the Corporation and [REDACTED] (the “Construction Contractor”);
- (4) an insurance trust agreement between the Corporation, Contracting Authority, the Lenders’ Agent and [REDACTED]; and
- (5) *[Note to Completion: List other documents delivered at Financial Close.]*,

(collectively, the “Documents”); or

- (ii) restrict or limit the authority of the directors or shareholders of the Corporation by resolution to delegate the powers set out in subparagraph (i) to a director or an officer of the Corporation.

2. Resolutions

- (a) Annexed hereto, forming part hereof and marked as **Schedule [“■”]** are true and complete copies of the resolutions of the [directors/shareholders] of the Corporation (the “Resolutions”), which have been duly and validly passed in accordance with applicable law, constituting authority and approval for the Corporation, *inter alia*, to enter into the Documents, in its own capacity or in its capacity as a partner of Project Co. The Resolutions are the only resolutions of the Corporation and Project Co pertaining to the subject matter thereof and the same are in full force and effect, unamended as of the date hereof.
- (b) The authorization, execution and delivery of each Document contemplated in the Resolutions, and the performance by the Corporation, in its own capacity or in its capacity as a partner of Project Co (as the case may be), of its obligations thereunder, do not constitute or result in a violation or breach or default under:
 - (i) the Articles, By-laws [, the Unanimous Shareholders’ Agreement] or the Project Co Partnership Agreement;
 - (ii) to the best of my knowledge and belief after due diligence, any order of any Canadian or Ontario governmental body by which the Corporation or Project Co is bound;
 - (iii) to the best of my knowledge and belief after due diligence, the terms of any agreement or instrument under which any of the Corporation’s or Project Co’s property or assets are bound; or
 - (iv) to the best of my knowledge and belief after due diligence, any writ, judgment, injunction, determination or award which is binding on the Corporation, Project Co or any of their respective properties.
- (c) To the best of my knowledge and belief after due diligence, there are no, actions, suits, proceedings, or investigations pending or threatened in writing against the Corporation or Project Co at law or in equity before any Governmental Authority or arbitral body (whether or not covered by insurance) of which the Corporation or Project Co has received written

notice and that individually or in the aggregate could result in any material adverse effect on the business, properties, or assets, or the condition, financial or otherwise, of the Corporation or Project Co or in any impairment of the ability of the Corporation, in its own capacity or in its capacity as a partner of Project Co, or Project Co to perform their respective obligations under the Documents, and neither the Corporation nor Project Co has any knowledge of any violation or default with respect to any order, writ, injunction, or decree of any Governmental Authority or arbitral body that could result in any such material adverse effect or impairment.

- (d) To the best of my knowledge and belief after due diligence, no consent, approval or other order of any Canadian or Ontario Governmental Authority which has not been obtained is required to permit the Corporation to execute and deliver the Documents, in its own capacity or as a partner of Project Co.
- (e) All steps necessary under the Project Co Partnership Agreement to authorize the entering into of the Documents and the performance by Project Co of its obligations thereunder have been taken.

3. No Breach or Default

Neither the execution and delivery by the Corporation of the Documents, in its own capacity or in its capacity as a partner of Project Co (as the case may be), nor the consummation of the transactions therein contemplated nor the fulfilment or compliance with the terms thereof will contravene or result in a breach of any of the terms, conditions or provisions of, or constitute a default under the Articles, By-laws, **[Unanimous Shareholders' Agreement,]** Project Co Partnership Agreement or under any other agreement binding on the Corporation or Project Co.

4. Specimen Signatures

The persons whose names are set forth below are, at the date hereof, officers and/or directors of the Corporation, duly elected or appointed to the office or offices set forth opposite their respective names and authorized to execute the Documents on behalf of the Corporation, including as a partner of Project Co. The signatures set forth opposite their respective names are the true signatures of those persons:

<u>NAME</u>	<u>POSITION</u>	<u>SIGNATURE</u>
■		_____
■		_____
■		_____
■		_____

5. Capital

Listed below are all of the issued and outstanding shares in the capital of the Corporation and the registered owner of such shares:

ISSUED SHARES

REGISTERED OWNER

Listed below are all of the issued and outstanding partnership units in the capital of Project Co and the registered owner of such units:

ISSUED UNITS

REGISTERED OWNER

Attached hereto as Schedule [“■”] are true copies of all certificates in respect of such issued and outstanding shares and units. Neither the Corporation nor Project Co has issued securities, including securities convertible or exchangeable into shares and/or securities in respect of debt, other than such issued and outstanding shares and units as are listed above.

DATED this ____ day of _____, 20■.

Name:

Title:

APPENDIX C

FORM OF PROJECT CO/PROJECT CO PARTY/CONSTRUCTION GUARANTOR OPINION

[INSERT DATE]

[REDACTED]

[REDACTED]

■ LLP

■

Dear Sirs/Mesdames:

Re: Regional Express Rail – Davenport Diamond Rail Grade Separation

We have acted as counsel to [REDACTED] (“**Project Co**”), a general partnership formed between [REDACTED] (“[REDACTED]”) and [REDACTED] (“[REDACTED]”), each as general partners (together, [REDACTED] and [REDACTED], the “**General Partners**” and each, individually, a “**General Partner**”) and [REDACTED] (the “**Construction Contractor**”), acting by its general partner Graham Construction and Engineering Inc. (“[REDACTED]”) in connection with the alternative financing and procurement transaction whereby Project Co has agreed to enter into a design, build and finance agreement for Regional Express Rail – Davenport Diamond Rail Grade Separation.

[Note to Completion: Additional parties to be added depending on consortium structure and/or the financing package.]

This opinion is being delivered to Ontario Infrastructure and Lands Corporation, as agent for Her Majesty the Queen in right of Ontario and Metrolinx, a non-share capital corporation continued under the *Metrolinx Act, 2006*, S.O. 2006, c. 16 and a Crown agency in accordance with the *Crown Agency Act*, R.S.O. 1990, c. 48 (collectively, the “**Contracting Authority**”) and its counsel pursuant to Section 1.18 of Schedule 2 to the project agreement made as of ■, 2019 between Contracting Authority and Project Co (as the same may be amended, supplemented, restated or otherwise modified from time to time, the “**Project Agreement**”).

All capitalized terms used but not otherwise defined in this opinion shall have the respective meanings ascribed thereto in the Project Agreement.

In our capacity as counsel to Project Co and the Construction Contractor, we have participated in the preparation and negotiation, and have examined an executed copy, of each of the following documents (unless otherwise indicated, all documents are dated as of ■, 2019:

1. the Project Agreement; and
2. the following project documents (collectively, the “**Implementation Documents**”):

- (a) the Design and Construction Contract;
- (b) the Insurance Trust Agreement;
- (c) the Lenders' Direct Agreement;
- (d) the Construction Contractor's Direct Agreement;
- (e) the Independent Certifier Agreement;
- (f) the Lending Agreements;
- (g) the Performance Bond;
- (h) the Multiple Oblige Rider to the Performance Bond;
- (i) the Labour and Material Payment Bond;
- (j) the Multiple Oblige Rider to the Labour and Material Payment Bond; and
- (k) the Performance Guarantee of Construction Guarantor.
- (l) *[Note to Completion: List other documents delivered at the date of the Project Agreement.]*

We have also examined the **[general partnership agreement]** between the General Partners made as of ■ (the "**Partnership Agreement**") and the **[limited partnership agreement]**, governing the Construction Contractor, made between **[REDACTED]** and ■ as of ■ (the "**Limited Partnership Agreement**").

The Project Agreement and the Implementation Documents are hereinafter collectively referred to as the "**Documents**", and each is individually referred to as a "**Document**".

[Note to Completion: Additional documents to be added depending on consortium structure and/or the financing package.]

We are qualified to practise law in the Province of Ontario. We have made no investigation of the laws of any jurisdiction other than Ontario, and the opinions expressed below are confined to the laws of Ontario and the federal laws of Canada applicable therein as at the date hereof.

We do not act as corporate counsel to **[Project Co or the Construction Contractor]**, nor have we participated in the general maintenance of their corporate records and corporate proceedings. Therefore, in expressing certain of the opinions below, we have, where indicated, relied exclusively, and without any independent investigation or enquiry, on certificates of public officials and a certificate of an officer of each of Project Co and the Construction Contractor dated as of the date hereof (the "**Officer's Certificates**") as to certain factual matters.

Searches and Reliance

We have conducted, or have caused to be conducted, the searches identified in Schedule "A" (the "**Searches**") for filings or registrations made in those offices of public record listed in Schedule "A". The

Searches were conducted against the current name and all former names of Project Co and the Construction Contractor (including, in each case, both the English and French versions, if any). The results of the Searches are set out in Schedule “A”.

We have also made such investigations and examined originals or copies, certified or otherwise identified to our satisfaction, of such certificates of public officials and of such other certificates, documents and records as we have considered necessary or relevant for purposes of the opinions expressed below, including the Officer’s Certificates.

We have relied exclusively, and without any independent investigation or enquiry, on the Officer’s Certificates and the certificates of public officials with respect to certain factual matters.

In connection with the opinions set forth in paragraphs 1 and 2 below, we have relied exclusively on Certificates of Status issued by the **[Ministry of Government Services (Ontario)]** of even date, copies of which are attached as Schedule “B”.

In connection with the opinions set forth in paragraphs 4, 6, 8, 12 and 14 below, we have relied exclusively, and without any independent investigation or enquiry, upon the opinion of ■ dated ■, 20■ (the “**CC Opinion**”), a copy of which has been delivered to you. To the extent that the CC Opinion contains assumptions, qualifications, limitations or definitions, or is expressed as relying on any certificate(s) or other documents identified therein, the opinions herein expressed in reliance on the CC Opinion should be read as incorporating the identical assumptions, qualifications, limitations, definitions and reliances.

Assumptions

For the purposes of the opinions expressed herein, we have assumed:

1. The genuineness of all signatures, the authenticity of all documents submitted to us as originals, the conformity to originals of all documents submitted to us as certified, true, conformed, photostatic or notarial copies or facsimiles thereof and the authenticity of the originals of such certified, true, conformed, photostatic or notarial copies or facsimiles.
2. Each of the parties (other than Project Co and the Construction Contractor) to each of the Documents is and was, at all relevant times, a subsisting corporation, partnership, limited partnership, limited liability company or trust, as applicable, under the laws of its jurisdiction of formation.
3. Each of the parties (other than Project Co and the Construction Contractor) has (and had) the corporate power, authority and capacity to own its property and assets and to carry on its business as such business is now (or as was then) being carried on by it, has (or had) all requisite corporate power, authority and capacity to execute and deliver each Document to which it is party and to perform its obligations thereunder, has taken all necessary corporate action, as applicable, to authorize the execution and delivery of each Document to which it is a party and the performance of its obligations thereunder, and has duly executed and delivered each Document to which it is a party and each Document to which it is a party is a legal, valid and binding obligation of such party enforceable against it in accordance with its terms.
4. The completeness, truth and accuracy of all facts set forth in the Officer’s Certificates.

5. The completeness, truth and accuracy of all facts set forth in official public records and certificates and other documents supplied by public officials.
6. Value has been given by each of the parties (other than Project Co and the Construction Contractor) to Project Co and the Construction Contractor.

Opinions

Based upon and subject to the foregoing, and to the qualifications, exceptions and limitations hereinafter expressed, we are of the opinion that, as of the date hereof:

Formation, Incorporation and Existence

1. Project Co has been formed and is existing as a general partnership under the [REDACTED]. The General Partners are the sole partners of Project Co.
2. [REDACTED] is a corporation incorporated under the laws of [REDACTED] and has not been dissolved.
3. [REDACTED] is a corporation incorporated under the laws of [REDACTED] and has not been dissolved.
4. The Construction Contractor is a limited partnership formed and existing under [REDACTED]. [REDACTED] is the sole general partner of the Construction Contractor.
5. [REDACTED] is a corporation incorporated under the laws of [REDACTED] and has not been dissolved.

Corporate Power and Capacity

6. Each General Partner has the corporate power and capacity to own or lease properties and assets in the name of Project Co, to carry on the business of Project Co as it is currently being conducted and as it is contemplated to be conducted under the Project Agreement, and to enter into and perform its obligations under each of the Documents to which it is a party, in its capacity as a general partner of Project Co.
7. [REDACTED] has the corporate power and capacity to own or lease its properties and assets, to carry on its business as it is currently being conducted and as it is contemplated to be conducted under the Project Agreement, and to enter into and perform its obligations under each of the Documents to which it is a party.
8. [REDACTED] has the corporate power and capacity to own or lease its properties and assets, to carry on its business as it is currently being conducted and as it is contemplated to be conducted under the Project Agreement, and to enter into and perform its obligations under each of the Documents to which it is a party.
9. [REDACTED] has the corporate power and capacity to own or lease properties and assets in the name of the Construction Contractor, to carry on the business of the Construction Contractor as it is currently being conducted and as it is contemplated to be conducted under the Documents, and

to enter into and perform its obligations under each of the Documents to which it is a party, in its capacity as general partner of the Construction Contractor.

Corporate Authorization

10. All necessary corporate action on the part of each General Partner and all necessary action in accordance with the provisions of the Partnership Agreement have been taken to authorize the execution and delivery by such General Partner, in its capacity as a general partner of Project Co, of each of the Documents to which Project Co is a party, and the performance by Project Co of its obligations thereunder.
11. **[REDACTED]** has taken all necessary corporate action to authorize the execution and delivery of, and the performance of its obligations under, each of the Documents to which it is a party.
12. **[REDACTED]** has taken all necessary corporate action to authorize the execution and delivery of, and the performance of its obligations under, each of the Documents to which it is a party.
13. All necessary corporate action on the part of **[REDACTED]** and all necessary action in accordance with the provisions of the Limited Partnership Agreement have been taken to authorize the execution and delivery by **[REDACTED]**, in its capacity as a general partner of the Construction Contractor, of each of the Documents to which the Construction Contractor is a party, and the performance by the Construction Contractor of its obligations thereunder.

Execution and Delivery

14. Each of the General Partners, in their respective capacities as general partners of Project Co, have duly executed and delivered each of the Documents to which Project Co is a party.
15. **[REDACTED]** has duly executed and delivered each of the Documents to which it is a party.
16. **[REDACTED]** has duly executed and delivered each of the Documents to which it is a party.
17. **[REDACTED]**, in its capacity as general partner of the Construction Contractor, has duly executed and delivered each of the Documents to which the Construction Contractor is a party.

Enforceability

18. Each of the Documents to which Project Co is a party constitutes a legal, valid and binding obligation of Project Co and each of the General Partners in their respective capacities as general partners of Project Co, enforceable against each of them in accordance with its terms.
19. Each of the Documents to which **[REDACTED]** is a party constitutes a legal, valid and binding obligation of **[REDACTED]**, enforceable against it in accordance with its terms.
20. Each of the Documents to which **[REDACTED]** is a party constitutes a legal, valid and binding obligation of **[REDACTED]**, enforceable against it in accordance with its terms.
21. Each of the Documents to which the Construction Contractor is a party constitutes a legal, valid and binding obligation of the Construction Contractor and **[REDACTED]**, in its capacity as general partner of the Construction Contractor, enforceable against it in accordance with its terms.

No Breach or Default

22. The execution and delivery by the General Partners, in their respective capacities as general partners of Project Co, of the Documents to which Project Co is a party do not, and the performance by the General Partners, in their respective capacities as general partners of Project Co, of Project Co's obligations under each such Document in accordance with its terms will not, breach or constitute a default under (i) its articles, by-laws [**or unanimous shareholders' agreement,**] (ii) the Partnership Agreement or (iii) the provisions of any law, statute, rule or regulation to which Project Co is subject.
23. The execution and delivery by [REDACTED] of the Documents to which it is a party does not, and the performance by [REDACTED] of its or Project Co's obligations under each such Document in accordance with its terms will not, breach or constitute a default under (i) its articles or by-laws, or any unanimous shareholder's agreement binding on [REDACTED] or (ii) the provisions of any law, statute, rule or regulation to which Project Co is subject.
24. The execution and delivery by [REDACTED] of the Documents to which it is a party does not, and the performance by [REDACTED] of its or Project Co's obligations under each such Document in accordance with its terms will not, breach or constitute a default under (i) its articles or by-laws, or any unanimous shareholder's agreement binding on [REDACTED] or (ii) the provisions of any law, statute, rule or regulation to which Project Co is subject.
25. The execution and delivery by [REDACTED], in its capacity as general partner of the Construction Contractor, of the Documents to which the Construction Contractor is a party do not, and the performance by [REDACTED], in its capacity as general partner of the Construction Contractor, of the Construction Contractor's obligations under each such Document in accordance with its terms will not, breach or constitute a default under (i) its articles, by-laws [**or unanimous shareholders' agreement,**] (ii) the Limited Partnership Agreement or (iii) the provisions of any law, statute, rule or regulation to which the Construction Contractor is subject.

Regulatory Approvals

26. No authorization, consent, permit or approval of, or other action by, or filing with or notice to, any governmental agency or authority, regulatory body, court, tribunal or other similar entity having jurisdiction is required in connection with the execution and delivery by the General Partners, in their respective capacities as general partners of Project Co, of the Documents to which Project Co is a party and the performance of Project Co's obligations at this time thereunder.
27. No authorization, consent, permit or approval of, or other action by, or filing with or notice to, any governmental agency or authority, regulatory body, court, tribunal or other similar entity having jurisdiction is required in connection with the execution and delivery by [REDACTED] of the Documents to which it is a party and the performance of its obligations at this time thereunder.
28. No authorization, consent, permit or approval of, or other action by, or filing with or notice to, any governmental agency or authority, regulatory body, court, tribunal or other similar entity having jurisdiction is required in connection with the execution and delivery by [REDACTED] of the Documents to which it is a party and the performance of its obligations at this time thereunder.

29. No authorization, consent, permit or approval of, or other action by, or filing with or notice to, any governmental agency or authority, regulatory body, court, tribunal or other similar entity having jurisdiction is required in connection with the execution and delivery by the [REDACTED], in its capacity as general partner of the Construction Contractor, of the Documents to which the Construction Contractor is a party and the performance of the Construction Contractor's obligations at this time thereunder.

Qualifications

Our opinions herein are subject to the following qualifications and reservations, namely:

1. The enforceability of any Document and the rights and remedies set out therein or any judgment arising out of or in connection therewith is subject to and may be limited by any applicable bankruptcy, reorganization, winding-up, insolvency, moratorium or other laws of general application affecting creditors' rights from time to time in effect.
2. The enforceability of each of the Documents and the rights and remedies set out therein is subject to and may be limited by general principles of equity, and no opinion is given as to any specific remedy that may be granted, imposed or rendered, including equitable remedies such as those of specific performance and injunction, or the availability of equitable defences.
3. The enforceability of any Document will be subject to the limitations contained in the *Limitations Act, 2002* (Ontario), and we express no opinion as to whether a court may find any provision of any Document to be unenforceable as an attempt to vary or exclude a limitation period under that Act.
4. Pursuant to the *Currency Act* (Canada), a judgment in money rendered by a Court in the Province of Ontario must be awarded in Canadian currency and such judgment may be based on a rate of exchange in effect other than the day of payment of the judgment.
5. To the extent that a particular contractual provision is characterized by a Court as a penalty and not as a genuine pre-estimate of damages, it will not be enforceable.
6. A Court may not treat as conclusive those certificates and determinations which the Documents state are to be so treated.
7. A receiver or receiver and manager appointed pursuant to the provisions of any Document, for certain purposes, may not be treated by a Court as being solely the agent of Project Co notwithstanding any agreement to the contrary.
8. The ability to recover or claim for certain costs or expenses may be subject to judicial discretion.
9. With respect to any provisions of the Documents pursuant to which the parties to such Documents are permitted or required to submit a dispute arising out of such Documents to arbitration, we express no opinion as to the enforceability of such arbitration provisions in all circumstances since under the *Arbitration Act, 1991* (Ontario) a court of competent jurisdiction in Ontario may, in its discretion and upon certain grounds, refuse to stay judicial proceedings in which event an arbitration under such arbitration provisions may not be commenced or continued. In addition, the *Arbitration Act, 1991* (Ontario) provides that a court may hear an appeal of an arbitration award on

- a question of law, or set aside an arbitration award or declare it invalid, in each case on certain prescribed grounds.
10. Any requirement in any of the Documents that interest be paid at a higher rate after than before default may not be enforceable.
 11. The effectiveness of provisions which purport to relieve a person from a liability or duty otherwise owed may be limited by law, and provisions requiring indemnification or reimbursement may not be enforced by a Court, to the extent that they relate to the failure of such person to perform such duty or liability.
 12. No opinion is expressed as to the enforceability of any provision contained in any Document which purports to sever from the Document any provision therein which is prohibited or unenforceable under applicable law without affecting the enforceability or validity of the remainder of the document.
 13. No opinion is expressed regarding any waiver of service of process, presentment, demand, protest or notice of dishonour which may be contained in any of the Documents.
 14. Any award of costs is in the discretion of a Court of competent jurisdiction.
 15. The enforceability of rights of indemnity set out in the Documents may be limited under applicable law to the extent that they directly or indirectly relate to liabilities imposed by law on Contracting Authority for which it would be contrary to public policy to require Project Co to indemnify Contracting Authority or to the extent that they constitute the indirect enforcement of a foreign revenue or penal law.
 16. We express no opinion as to the enforceability by any person who is not a party to the Documents of any provision therein that purports to bind or affect or confer a benefit on such person.

This opinion is being delivered solely in connection with the transaction addressed herein and may not be relied upon by any person other than the addressees, and their successors and permitted assigns, or for any purpose other than the transaction addressed herein.

Yours very truly,

[INSERT NAME OF LAW FIRM]

APPENDIX D-1

FORM OF CERTIFICATE OF AN OFFICER OF ONTARIO INFRASTRUCTURE AND LANDS
CORPORATION (THE “CORPORATION”)

TO: [REDACTED] (“Project Co”)

AND TO: [REDACTED]

AND TO: [REDACTED] (the “Lenders’ Agent”)

AND TO: [REDACTED]

RE: Project agreement (as amended, supplemented or modified from time to time, the “**Project Agreement**”) dated the [Insert Date] between the Corporation, a Crown agent, continued under the *Ontario Infrastructure and Lands Corporation Act, 2011*; Metrolinx, a non-share capital corporation continued under the *Metrolinx Act, 2006*, S.O. 2006, c. 16 and a Crown agency in accordance with the *Crown Agency Act*, R.S.O. 1990, c. 48; and GCRS Davenport General Partnership (“**Project Co**”)

I, ■, the ■ of the Corporation and an authorized signatory of the Corporation and being duly authorized by the Corporation to deliver this certificate, hereby make the following certifications and confirmations for and on behalf of the Corporation and without incurring personal liability and that the same may be relied upon by you without further inquiry:

1. Attached hereto as **Schedule “A”** is a true and complete copy of (i) the resolutions of the directors of the Corporation regarding the execution of public works projects undertaken by the Corporation and certain other matters set forth therein; and (ii) an excerpt of the resolutions of the directors of the Corporation relating to delegation of signing authority (collectively, the “**Execution Resolutions**”), which have been duly and validly passed in accordance with applicable law. The Execution Resolutions are the only resolutions of the Corporation pertaining to the subject matter thereof and the same are in full force and effect, unamended as of the date hereof.
2. Attached hereto as Schedule “B” is a true and complete copy of the resolutions of the directors of the Corporation approving the selection of Project Co as the successful bidder for the Regional Express Rail – Davenport Diamond Rail Grade Separation Project (the “**Project Resolutions**”). The Project Resolutions are the only resolutions of the Corporation pertaining to the subject matter thereof and the same is in full force and effect, unamended as of the date hereof.
3. To the knowledge of the undersigned, after due inquiry as of the date hereof, the Minister of Infrastructure (the “**Minister**”) has not given a direction pursuant to subsection 4(3) of the *Ontario Infrastructure and Lands Corporation Act, 2011*, S.O. 2011, c. 9, Schedule 32, as amended (the “**Act**”) that limits the scope of the objects of the Corporation as they are set out in subsection 4(1) of the Act.

4. The following named persons, on or as of the date hereof, are duly elected or appointed officers of the Corporation, as evidenced by the holding of the office or offices set forth opposite their names, are proper signing officers of the Corporation and are authorized to execute and deliver Project Documents (as such a term is defined in the Execution Resolutions referenced in item 1(i) above) relating to the Regional Express Rail – Davenport Diamond Rail Grade Separation Project on behalf of the Corporation. The signatures set forth opposite their respective names are the true signatures of those persons.

<u>NAME</u>	<u>POSITION</u>	<u>SIGNATURE</u>
■		_____
■		_____
■		_____
■		_____

DATED this ____ day of _____, 20[•].

Name: ■
Title: Secretary

APPENDIX D-2

FORM OF CERTIFICATE OF AN OFFICER OF METROLINX (THE “CORPORATION”)

TO: [REDACTED] (“Project Co”)

AND TO: [REDACTED]

AND TO: [REDACTED] (the “Lenders’ Agent”)

AND TO: [REDACTED]

RE: Project agreement (as amended, supplemented or modified from time to time, the “**Project Agreement**”) dated the [Insert Date] between the Corporation, a non-share capital corporation continued under the *Metrolinx Act, 2006*, S.O. 2006, c. 16 and a Crown agency in accordance with the *Crown Agency Act*, R.S.O. 1990, c. 48; Ontario Infrastructure and Lands Corporation, a Crown agent continued under the *Ontario Infrastructure and Lands Corporation Act, 2011*; and GCRS Davenport General Partnership (“**Project Co**”)

I, _____, the _____ of the Corporation and an authorized signatory of the Corporation hereby certify and confirm for and on behalf of the Corporation and without incurring personal liability that:

1. the addressees may rely on the certifications and confirmations set for the below without further inquiry;
2. attached hereto as Schedule “A” is a true and complete copy of a Resolution of the Board of Directors of the Corporation passed on the _____ day of _____ 20____ (the “**Resolution**”) authorizing Metrolinx to enter into the Project Agreement and all necessary legal agreements that may be required to give effect to it on terms and conditions and in form satisfactory to the Executive Vice President of Metrolinx and authorizing the signing officers of Metrolinx to execute the Project Agreement and all necessary legal agreements and related documentation to give effect to the Resolution; and
3. the Resolution has been duly and validly passed and is in full force and effect and has not been superseded or amended as of the date hereof.

Dated this _____ day of _____, 20█.

Name:
Title:

APPENDIX E
FORM OF DECLARATION OF MANAGEMENT
ONTARIO INFRASTRUCTURE AND LANDS CORPORATION

(the “Corporation”)

DECLARATION OF MANAGEMENT

WHEREAS the Corporation, a Crown agent, continued under the *Ontario Infrastructure and Lands Corporation Act, 2011*; Metrolinx, a non-share capital corporation continued under the *Metrolinx Act, 2006*, S.O. 2006, c. 16 and a Crown agency in accordance with the *Crown Agency Act*, R.S.O. 1990, c. 48; and [REDACTED] propose to enter into a Project Agreement relating to the Regional Express Rail – Davenport Diamond Rail Grade Separation Project in Toronto, Ontario (the “**Project**”);

AND WHEREAS the Corporation will from time to time enter into agreements for the design, construction and/or facilities management of the Project assigned to the Corporation by the Minister of Infrastructure and as well as ancillary agreements, instruments, certificates and other documents required to give effect to, or contemplated to be delivered in accordance with the Project (collectively, “**Project Documents**”);

NOW THEREFORE THE CORPORATION’S MANAGEMENT HEREBY DECLARES THAT:

1. by resolution of the board of directors of the Corporation passed on ■, the board of directors of the Corporation has authorized the Corporation’s management (for and in the name of and on behalf of the Corporation) to execute and deliver the Project Documents and do all such other acts and things as the Corporation’s management may determine to be necessary or advisable to carry out the transactions contemplated by the applicable Project Documents;
2. the Corporation’s management may execute and deliver the Project Documents to which the Corporation may become a party and any other documents, instruments or agreements delivered in connection with the Project Documents from time to time (collectively, together with the Project Documents, the “**Documents**”) all in such form and on such terms as the management of the Corporation executing such Documents in accordance with this declaration may approve, such approval to be evidenced conclusively by the execution of such Documents by the Corporation’s management; and
3. the Project Documents to be executed and delivered by the Corporation in connection with the Project and the transactions and obligations contemplated thereunder are for the purpose of carrying out the objects of the Corporation and the Corporation shall not and will not assert the contrary against any person dealing with the Corporation or any person who has acquired an interest in the Project from the Corporation.

THIS DECLARATION may be signed in counterparts, and all such counterparts, when taken together, shall constitute one and the same declaration, effective on this date.

DATED this _____ day of _____, 20__.

Name:
Title: General Counsel

SCHEDULE 3

SUBCONTRACTOR'S DIRECT AGREEMENT

THIS AGREEMENT is made as of ■ day of ■, 20■

BETWEEN:

ONTARIO INFRASTRUCTURE AND LANDS CORPORATION, a Crown agent, continued under the *Ontario Infrastructure and Lands Corporation Act, 2011*, S.O. 2011

– AND –

METROLINX, a non-share capital corporation continued under the *Metrolinx Act, 2006*, S.O. 2006, c. 16 and a Crown agency in accordance with the *Crown Agency Act*, R.S.O. 1990, c. 48

(collectively, “**Contracting Authority**”)

– AND –

GCRS DAVENPORT GENERAL PARTNERSHIP, [REDACTED]

(“**Project Co**”)

– AND –

[REDACTED]

(the “**Construction Contractor**”)

– AND –

[■, [REDACTED]

(the “**Subcontractor**”)

WHEREAS:

- A. Contracting Authority and Project Co have entered into a project agreement (the “**Project Agreement**”), which requires Project Co to enter into, and to cause the Construction Contractor and the Subcontractor to enter into, this Subcontractor's Direct Agreement with Contracting Authority.
- B. Project Co and the Construction Contractor have entered into the Design and Construction Contract, which requires the Construction Contractor to enter into, and cause the Subcontractor to enter into, this Subcontractor's Direct Agreement with Contracting Authority.

- C. IO, as Crown agent and Metrolinx, as Crown agency, intend to enter into this Subcontractor's Direct Agreement in accordance with Applicable Law, and to be liable, on a joint and several basis, for all of the obligations of Contracting Authority pursuant to this Subcontractor's Direct Agreement, save and except as provided for in this Subcontractor's Direct Agreement.

NOW THEREFORE in consideration of the mutual covenants and agreements of the Parties hereinafter contained and for other good and valuable consideration, the receipt and sufficiency of which are hereby acknowledged, the Parties covenant and agree as follows:

1. DEFINITIONS

In this Schedule 3 – Subcontractor's Direct Agreement, unless the context indicates a contrary intention, terms which are defined in the Project Agreement (and not otherwise defined in this Schedule 3 – Subcontractor's Direct Agreement) shall have meanings given to them in the Project Agreement and the following terms shall have the following meanings:

- (a) **"Default Notice"** has the meaning given in Section 5(a);
- (b) **"Novation Notice"** has the meaning given in Section 6(b);
- (c) **"Party"** means Contracting Authority, Project Co, the Construction Contractor or the Subcontractor, and **"Parties"** means, collectively, Contracting Authority, Project Co, the Construction Contractor and the Subcontractor;
- (d) **"Subcontract"** means the subcontract ■ *[Note to Completion: Describe applicable subcontract.];* and
- (e) **"Substitute"** has the meaning given in Section 6(b).

2. INTERPRETATION

This Subcontractor's Direct Agreement shall be interpreted according to the following provisions, unless the context requires a different meaning:

- (a) The headings in this Subcontractor's Direct Agreement are for convenience of reference only, shall not constitute a part of this Subcontractor's Direct Agreement, and shall not be taken into consideration in the interpretation of, or affect the meaning of, this Subcontractor's Direct Agreement.
- (b) Unless the context otherwise requires, references to specific Sections, Clauses, Paragraphs, Subparagraphs, and other divisions are references to such Sections, Clauses, Paragraphs, Subparagraphs, or divisions of this Subcontractor's Direct Agreement and the terms "Section" and "Clause" are used interchangeably and are synonymous.
- (c) Words importing persons or parties are to be broadly interpreted and include an individual, corporation, limited liability company, joint stock company, firm, partnership, joint venture, trust, unincorporated organization, Governmental Authority, unincorporated body of persons or association and any other entity having legal capacity, and the heirs,

beneficiaries, executors, administrators or other legal representatives of a person in such capacity.

- (d) Unless the context otherwise requires, wherever used herein the plural includes the singular, the singular includes the plural, and each of the masculine, feminine and neuter genders include all other genders.
- (e) References to any standard, principle, agreement or document include (subject to all relevant approvals and any other provisions of this Subcontractor's Direct Agreement concerning amendments) a reference to that standard, principle, agreement or document as amended, supplemented, restated, substituted, replaced, novated or assigned.
- (f) The words in this Subcontractor's Direct Agreement shall bear their natural meaning.
- (g) References containing terms such as:
 - (i) "hereof", "herein", "hereto", "hereinafter", and other terms of like import are not limited in applicability to the specific provision within which such references are set forth but instead refer to this Subcontractor's Direct Agreement taken as a whole; and
 - (ii) "includes" and "including", whether or not used with the words "without limitation" or "but not limited to", shall not be deemed limited by the specific enumeration of items but shall, in all cases, be deemed to be without limitation and construed and interpreted to mean "includes without limitation" and "including without limitation".
- (h) In construing this Subcontractor's Direct Agreement, the rule known as the *ejusdem generis rule* shall not apply nor shall any similar rule or approach to the construction of this Subcontractor's Direct Agreement and, accordingly, general words introduced or followed by the word "other" or "including" or "in particular" shall not be given a restrictive meaning because they are followed or preceded (as the case may be) by particular examples intended to fall within the meaning of the general words.
- (i) Where this Subcontractor's Direct Agreement states that an obligation shall be performed "no later than" or "within" or "by" a stipulated date or event which is a prescribed number of days after a stipulated date or event, the latest time for performance shall be 5:00 p.m. on the last day for performance of the obligation concerned, or, if that day is not a Business Day, 5:00 p.m. on the next Business Day.
- (j) Where this Subcontractor's Direct Agreement states that an obligation shall be performed "on" a stipulated date, the latest time for performance shall be 5:00 p.m. on that day, or, if that day is not a Business Day, 5:00 p.m. on the next Business Day.
- (k) Any reference to time of day or date means the local time or date in Toronto, Ontario.
- (l) Unless otherwise indicated, time periods will be strictly construed.

- (m) Whenever the terms “will” or “shall” are used in this Subcontractor’s Direct Agreement they shall be construed and interpreted as synonymous and to read “shall”.

3. CONFLICT IN DOCUMENTS

- (a) In the event of ambiguities, conflicts or inconsistencies between or among this Subcontractor’s Direct Agreement, the Construction Contractor’s Direct Agreement, the Project Agreement and the Design and Construction Contract, this Subcontractor’s Direct Agreement shall prevail.
- (b) In the event of ambiguities, conflicts or inconsistencies between or among this Subcontractor’s Direct Agreement and the Lenders’ Direct Agreement, the Lenders’ Direct Agreement shall prevail.

4. AGREEMENTS

- (a) If the Subcontractor gives the Construction Contractor any notice of any default(s) under the Subcontract that may give the Subcontractor a right to terminate the Subcontract or to treat it as having been repudiated by the Construction Contractor or to discontinue the Subcontractor’s performance thereunder, then the Subcontractor shall concurrently provide Project Co and Contracting Authority with a copy of such notice, an executed copy of the Subcontract and set out in reasonable detail the default(s).

5. NO TERMINATION BY SUBCONTRACTOR WITHOUT DEFAULT NOTICE

The Subcontractor shall not exercise any right it may have to terminate the Subcontract or to treat it as having been repudiated by the Construction Contractor or to discontinue the Subcontractor’s performance thereunder unless:

- (a) the Subcontractor first delivers an executed copy of the Subcontract and a written notice (a “**Default Notice**”) to Contracting Authority setting out in reasonable detail the default(s) on which the Subcontractor intends to rely in terminating the Subcontract or to treat it as having been repudiated by the Construction Contractor or to discontinue the Subcontractor’s performance thereunder; and
- (b) within a period of five Business Days of Contracting Authority receiving the Default Notice the default(s) on which the Subcontractor intends to rely in terminating the Subcontract or to treat it as having been repudiated by the Construction Contractor or to discontinue the Subcontractor’s performance thereunder have not been remedied; and provided that if, within such period of five Business Days, Contracting Authority agrees to pay the Subcontractor’s reasonable costs of continued performance, such period of five Business Days shall be extended to 45 days.

6. NOVIATION OF THE SUBCONTRACT

- (a) The Subcontractor acknowledges and agrees that where the Design and Construction Contract has been terminated:

- (i) by Project Co;
- (ii) as a result of the termination of the Project Agreement; or
- (iii) due to the insolvency of the Construction Contractor,

the Subcontract shall not terminate solely by reason of the termination of the Design and Construction Contract unless Contracting Authority shall have failed to request a novation of the Subcontract pursuant to Section 6(b) within 20 days following the date of such termination.

- (b) Contracting Authority may at any time if:
 - (i) the Project Agreement and the Design and Construction Contract have been terminated; or
 - (ii) Contracting Authority's right to terminate the Project Agreement has arisen and is continuing and as a result of such termination of the Project Agreement, the Design and Construction Contract would be terminated,

deliver a notice (a "**Novation Notice**") electing to novate the Subcontract either to Contracting Authority or a third party designated by Contracting Authority in the Novation Notice (the "**Substitute**"), provided that Contracting Authority can demonstrate to the Subcontractor, acting reasonably, that the Substitute shall have sufficient financial resources, or shall be supported by a satisfactory guarantee, to carry out the obligations of the Substitute under the Subcontract.

- (c) Subject to Section 6(d), upon receipt by the Subcontractor of a Novation Notice:
 - (i) the Construction Contractor and the Subcontractor will be deemed to be released from their existing and future obligations under the Subcontract to each other (except with respect to any and all indemnities from the Construction Contractor or the Subcontractor to the other in respect of the period prior to the receipt of the Novation Notice), and Contracting Authority or the Substitute, as applicable, and the Subcontractor will be deemed to assume those same existing and future obligations towards each other (except in respect of the aforesaid indemnities);
 - (ii) the existing and future rights of the Construction Contractor against the Subcontractor under the Subcontract and vice versa will be deemed to be cancelled (except with respect to any and all indemnities from the Construction Contractor or the Subcontractor to the other in respect of the period prior to the receipt of the Novation Notice), and Contracting Authority or the Substitute, as applicable, and the Subcontractor will be deemed to acquire those same existing and future rights against each other (except in respect of the aforesaid indemnities), subject to any applicable credit from the Subcontractor to Contracting Authority if Contracting Authority pays for the Subcontractor's reasonable costs of continued performance pursuant to Section 5;

- (iii) any guarantee, bond or covenant in favour of the Construction Contractor from any third party in respect of any term, provision, condition, obligation, undertaking or agreement on the part of the Subcontractor to be performed, observed or carried out by the Subcontractor as contained in, referred to, or inferred from the Subcontract shall be assigned, novated or granted, as required by Contracting Authority or the Substitute, as applicable, each acting reasonably, to Contracting Authority or the Substitute, as applicable, and the Subcontractor shall cause such assignment, novation or grant on substantially the same terms and conditions as the original guarantee, bond or covenant, provided, however, that where Construction Contractor shall continue to hold, or shall continue to be entitled to or have rights under, such guarantee, bond or covenant as security for any obligations of the Subcontractor, the assignment, novation or grant of the guarantee, bond or covenant to the extent of any such obligations to Construction Contractor shall be conditional on the satisfaction of those obligations to Construction Contractor; and
- (iv) at Contracting Authority's request, the Subcontractor shall enter into, and shall cause any guarantor, covenantor or surety under any guarantee, bond or covenant referred to in Section 6(c)(iii) to enter into, and Contracting Authority shall or shall cause the Substitute to enter into, as applicable, all such agreements or other documents as reasonably necessary to give effect to the foregoing, including an agreement between Contracting Authority or the Substitute, as applicable, and the Subcontractor, acceptable to Contracting Authority and the Subcontractor, each acting reasonably, on substantially the same terms as the Subcontract.
- (d) The Construction Contractor shall, at its own cost, cooperate fully with Contracting Authority and the Substitute in order to achieve a smooth transfer of the Subcontract to Contracting Authority or the Substitute, as applicable, and to avoid or mitigate in so far as reasonably practicable any inconvenience, including the administration of the Subcontract, ongoing supervisory activities and scheduling.
- (e) The rights granted by Section 6(b) shall be of no force or effect if, at any time the Subcontractor receives a Novation Notice, the Subcontractor has already received notice in writing from another entity entitled to the benefit of step-in rights relating to the Subcontract that it is or has validly exercised those step-in rights. If the Subcontractor receives any such notice on the same day as a Novation Notice, the Novation Notice shall be effective, except where the other notice is given by the Lenders, in which case such other notice and not the Novation Notice shall be effective.
- (f) If Contracting Authority gives a Novation Notice within the time provided hereunder at any time after the Subcontractor has terminated the Subcontract or treated it as having been repudiated by Construction Contractor or discontinued the Subcontractor's performance thereunder in accordance with the terms of this Subcontractor's Direct Agreement, the Subcontractor agrees that the Subcontract shall be reinstated and deemed to have continued despite any termination or treatment as having been repudiated, and Contracting Authority shall pay the Subcontractor's reasonable costs for re-commencing the obligations it has under the Subcontract and the Subcontractor shall be entitled to reasonable compensation and/or relief for re-commencing such obligations, having regard to the additional costs and

delays incurred as a result of having terminated the Subcontract or having treated it as being repudiated by Construction Contractor or having discontinued its performance thereunder.

- (g) The Subcontractor acknowledges that if Contracting Authority novates the Subcontract to itself pursuant to Section 6(b), Contracting Authority shall have the right to further novate the Subcontract to a Substitute in accordance with and otherwise on, and subject to, the terms and conditions of this Subcontractor's Direct Agreement.

7. SUBCONTRACTOR LIABILITY

- (a) The liability of the Subcontractor hereunder shall not be modified, released, diminished or in any way affected by:
 - (i) any independent inspection, investigation or enquiry into any matter which may be made or carried out by or for Contracting Authority, or by any failure or omission to carry out any such inspection, investigation or enquiry; or
 - (ii) the appointment by Contracting Authority of any other person to review the progress of or otherwise report to Contracting Authority in respect of the Project, or by any action or omission of such person whether or not such action or omission might give rise to any independent liability of such person to Contracting Authority,

provided always that nothing in this Section 7 shall modify or affect any rights which the Subcontractor might have otherwise had to claim contribution from any other person whether under statute or common law.

- (b) In the event Contracting Authority delivers a Novation Notice, the Subcontractor shall have no greater liability to Contracting Authority or any Substitute than it would have had to Construction Contractor under the Subcontract, and the Subcontractor shall be entitled in any proceedings by Contracting Authority or any Substitute to rely on any liability limitations in the Subcontract.

8. PROJECT CO AND CONSTRUCTION CONTRACTOR AS PARTY

- (a) Project Co acknowledges and agrees that the Construction Contractor shall not be in breach of the Design and Construction Contract by complying with its obligations hereunder.
- (b) Construction Contractor acknowledges and agrees that the Subcontractor shall not be in breach of the Subcontract by complying with its obligations hereunder.

9. ASSIGNMENT

- (a) Project Co shall not, without the prior written consent of Contracting Authority, assign, transfer, charge, subcontract, subparticipate or otherwise dispose of any interest in this Subcontractor's Direct Agreement except to the extent entitled to do so under the Project Agreement.

- (b) Contracting Authority may assign or otherwise dispose of the benefit of the whole or part of this Subcontractor’s Direct Agreement to any person to whom Contracting Authority may assign or otherwise dispose of its interest in the Project Agreement pursuant to Section 49.2 of the Project Agreement but only in conjunction therewith, and shall provide written Notice to Project Co, the Construction Contractor and the Subcontractor of such assignment or disposition.
- (c) The Construction Contractor shall not, without the prior written consent of Contracting Authority and Project Co, assign, transfer, charge, subcontract, subparticipate or otherwise dispose of any interest in this Subcontractor’s Direct Agreement except as may be permitted under the Design and Construction Contract.
- (d) The Subcontractor shall not, without the prior written consent of Contracting Authority and Project Co, assign, transfer, charge, subcontract, subparticipate or otherwise dispose of any interest in this Subcontractor’s Direct Agreement except as may be permitted under the Subcontract.

10. NOTICES

- (a) All notices, requests, demands, instructions, certificates, consents and other communications required or permitted under this Subcontractor’s Direct Agreement shall be in writing (whether or not “written notice” or “notice in writing” is specifically required by the applicable provision of this Subcontractor’s Direct Agreement) and served by sending the same by registered mail, facsimile or by hand (in each case, with a copy by electronic submission), as follows:

If to Contracting Authority:

[REDACTED]

Fax No.: **[REDACTED]**

Attn.: **[REDACTED]**

With a copy to:

[REDACTED]

Fax No.: **416.326.2791**

Attn.: **General Counsel**

If to Project Co:

[REDACTED]

Fax No.: **[REDACTED]**

Email: **[REDACTED]**

Attn.: **[REDACTED]**

with a copy to:

Email: [REDACTED]
Attn.: [REDACTED]

If to the Construction Contractor:

[REDACTED]

Fax No.: [REDACTED]
Email: [REDACTED]
Attn.: [REDACTED]

with a copy to:

Email: [REDACTED]
Attn.: [REDACTED]

If to the Subcontractor:

[Address]

Fax No.: ■
Attn: ■

- (b) Where any notice is provided or submitted to a Party via facsimile, an original of the notice sent via facsimile shall promptly be sent by regular mail or registered mail. For greater certainty, a notice given via facsimile shall not be invalid by reason only of a Party's failure to comply with this Section 10(b).
- (c) Any Party to this Subcontractor's Direct Agreement may, from time to time, change any of its contact information set forth in Section 10(a) by prior notice to the other Parties, and such change shall be effective on the Business Day that next follows the recipient Party's receipt of such notice unless a later effective date is given in such notice.
- (d) Subject to Sections 10(e), 10(f) and 10(g):
 - (i) a notice given by registered mail shall be deemed to have been received on the third Business Day after mailing;
 - (ii) a notice given by hand delivery shall be deemed to have been received on the day it is delivered; and
 - (iii) a notice given by facsimile shall be deemed to have been received on the day it is transmitted by facsimile.
- (e) If the Party giving the notice knows or ought reasonably to know of difficulties with the postal system which might affect negatively the delivery of mail, any such notice shall not

be mailed but shall be made or given by personal delivery or by facsimile transmission in accordance with this Section 10.

- (f) If any notice delivered by hand or transmitted by facsimile is so delivered or transmitted, as the case may be, either on a day that is not a Business Day or on a Business Day after 4:00 p.m. (recipient's local time), then such notice shall be deemed to have been received by such recipient on the next Business Day.
- (g) A notice given by facsimile shall be deemed to have been received by the recipient on the day it is transmitted only if a facsimile transmission report (maintained by the sender) indicates that the transmission of such notice was successful.

11. AMENDMENTS

This Subcontractor's Direct Agreement may not be varied, amended or supplemented except by an agreement in writing signed by duly authorized representatives of the Parties and stating on its face that it is intended to be an amendment, restatement or other modification, as the case may be, to this Subcontractor's Direct Agreement.

12. WAIVER

- (a) No waiver made or given by a Party under or in connection with this Subcontractor's Direct Agreement shall be binding or effective unless the waiver is in writing, signed by an authorized representative of the Party giving such waiver, and delivered by such Party to the other Parties. No waiver made with respect to any right, power or remedy in one instance will be deemed to be a waiver with respect to any other instance involving the exercise of such right, power, or remedy or with respect to any other right, power, or remedy.
- (b) Failure by any Party to exercise any of its rights, powers or remedies hereunder or its delay to do so shall not constitute a waiver of those rights, powers or remedies. The single or partial exercise of a right, power or remedy shall not prevent its subsequent exercise or the exercise of any other right, power or remedy.

13. RELATIONSHIP BETWEEN THE PARTIES

The Parties are independent contractors. This Subcontractor's Direct Agreement is not intended to and does not create or establish between the Parties any relationship as partners, joint venturers, employer and employee, master and servant, or, except as provided in this Subcontractor's Direct Agreement, of principal and agent.

14. JOINT AND SEVERAL

IO, as Crown agent and Metrolinx, as Crown agency, shall be liable, on a joint and several basis, for all of the obligations of Contracting Authority under this Subcontractor's Direct Agreement and for each covenant of the other under this Subcontractor's Direct Agreement.

15. CONTRACTING AUTHORITY DESIGNATE

At any time and from time to time, the Crown may designate any ministry, branch, agency, division, department or office of the Government of Ontario to carry out administrative responsibility for the rights and obligations of Contracting Authority under this Subcontractors' Direct Agreement and Project Co, the Construction Contractor and the Subcontractor may deal exclusively with the designated person in respect of all such matters and is entitled to rely on the actions, directions, requests, notices, consents, approvals, waivers, comments relating to the review of documentation and other administrative matters and decisions determined by such designated person from time to time, until the Crown has notified Project Co, the Construction Contractor and the Subcontractor in writing that such designated person is no longer the person designated by the Crown hereunder and such notice shall have effect on the later of the date of delivery of such notice and the date specified in the written notice. The Crown shall advise Project Co, the Construction Contractor and the Subcontractor in writing of any designation hereunder. The rights and obligations of the parties to this Subcontractors' Direct Agreement shall be in no way affected by reason of any such designation. Project Co, the Construction Contractor and the Subcontractor acknowledge the right of the Crown to delegate administrative responsibilities hereunder as set forth in this Section 15.

16. ENTIRE AGREEMENT

Except where provided otherwise in this Subcontractor's Direct Agreement, this Subcontractor's Direct Agreement constitutes the entire agreement between the Parties in connection with its subject matter and supersedes all prior representations, communications, negotiations and understandings, whether oral, written, express or implied, concerning the subject matter of this Subcontractor's Direct Agreement.

17. SEVERABILITY

Each provision of this Subcontractor's Direct Agreement shall be valid and enforceable to the fullest extent permitted by law. If any provision of this Subcontractor's Direct Agreement is declared invalid, unenforceable or illegal by the courts of a competent jurisdiction, such provision may be severed and such invalidity, unenforceability or illegality shall not prejudice or affect the validity, enforceability and legality of the remaining provisions of this Subcontractor's Direct Agreement. If any such provision of this Subcontractor's Direct Agreement is invalid, unenforceable or illegal, the Parties shall, acting in good faith, promptly negotiate new provisions to eliminate such invalidity, unenforceability or illegality and to restore this Subcontractor's Direct Agreement as near as possible to its original intent and effect.

18. ENUREMENT

This Subcontractor's Direct Agreement shall enure to the benefit of, and be binding on, each of the Parties and their respective successors and permitted transferees and assigns.

19. GOVERNING LAW AND JURISDICTION

- (a) This Subcontractor's Direct Agreement shall be governed by and construed in accordance with the laws of Ontario and the laws of Canada applicable therein and shall be treated in all respects as an Ontario contract, without regard to conflict of laws principles.

- (b) The Parties agree that the courts of the Province of Ontario and all courts competent to hear appeals therefrom shall have exclusive jurisdiction to hear and settle any action, suit, proceeding or dispute in connection with this Subcontractor's Direct Agreement and hereby irrevocably attorn to the exclusive jurisdiction of such courts.
- (c) Nothing in this Subcontractor's Direct Agreement affects the rights, protections and immunities of the Crown under the *Proceedings Against the Crown Act* (Ontario).

20. FURTHER ASSURANCE

Each Party shall do all things, from time to time, and execute all further documents necessary to give full effect to this Subcontractor's Direct Agreement.

21. LANGUAGE OF AGREEMENT

Each Party acknowledges having requested and being satisfied that this Subcontractor's Direct Agreement and related documents be drawn in English. Chacune des parties reconnaît avoir demandé que ce document et ses annexes soient rédigés en anglais et s'en déclare satisfaite.

22. COUNTERPARTS

This Subcontractor's Direct Agreement may be executed in one or more counterparts. Any single counterpart or a set of counterparts executed, in either case, by all the Parties shall constitute a full, original and binding agreement for all purposes. Counterparts may be executed either in original or faxed form provided that any Party providing its signature in faxed form shall promptly forward to such Party an original signed copy of this Subcontractor's Direct Agreement which was so faxed.

23. COPYRIGHT NOTICE

The Parties acknowledge that Queen's Printer for Ontario is the exclusive owner of copyright in the Project Agreement and this Subcontractors' Direct Agreement.

[SIGNATURE PAGES IMMEDIATELY FOLLOW]

IN WITNESS WHEREOF the Parties have executed this Subcontractor’s Direct Agreement as of the date first above written.

ONTARIO INFRASTRUCTURE AND LANDS CORPORATION, a Crown agent, continued under the *Ontario Infrastructure and Lands Corporation Act, 2011*

Per: _____
Name:
Title:

Per: _____
Name:
Title:

I/We have authority to bind the corporation.

METROLINX

Per: _____
Name:
Title:

Per: _____
Name:
Title:

I/We have authority to bind the corporation.

GCRS DAVENPORT GENERAL PARTNERSHIP,
by its partners:

GCP DAVENPORT INC.

Per: _____

Name: [REDACTED]

Title: [REDACTED]

I have authority to bind the corporation.

GRACORP DAVENPORT INC.

Per: _____

Name: [REDACTED]

Title: [REDACTED]

I have authority to bind the corporation.

[REDACTED]

Per: _____
Name:
Title:

Per: _____
Name:
Title:

I/We have authority to bind the corporation.

[SUBCONTRACTOR]

Per: _____
Name:
Title:

Per: _____
Name:
Title:

I/We have authority to bind the corporation.

SCHEDULE 4

LENDERS' DIRECT AGREEMENT

THIS AGREEMENT is made as of July 25, 2019

BETWEEN:

ONTARIO INFRASTRUCTURE AND LANDS CORPORATION, a Crown agent, continued under the *Ontario Infrastructure and Lands Corporation Act, 2011*, S.O. 2011

- AND -

METROLINX, a non-share capital corporation continued under the *Metrolinx Act, 2006*, S.O. 2006, c. 16 and a Crown agency in accordance with the *Crown Agency Act*, R.S.O. 1990, c. 48

(collectively, “**Contracting Authority**”)

- AND -

[REDACTED], acting as agent for and on behalf of the Lenders

(the “**Lenders' Agent**”)

- AND -

GCRS DAVENPORT GENERAL PARTNERSHIP, [REDACTED]

(“**Project Co**”)

WHEREAS:

- A. Metrolinx’s Regional Express Rail, which was announced in 2014 by the Province, is intended to transform the Greater Toronto and Hamilton Area over the next decade by introducing new and additional service on five of the seven GO Transit rail corridors.
- B. Contracting Authority wishes to procure the design, construction and financing of the Rail Grade Separation along the Rail Corridor in order to accommodate the anticipated Regional Express Rail services.
- C. Project Co will carry out the Works, which Works include the design, construction, and financing of the New Metrolinx Infrastructure and the New Third Party Infrastructure (the “**Project**”).
- D. Contracting Authority and Project Co have entered into a project agreement (the “**Project Agreement**”), which sets out the terms and conditions upon which Project Co shall perform the Works.

- E. Under the Lending Agreements, financing is to be provided to Project Co by the Lenders to finance the Works, conditional on, among other things, Project Co granting the Security to the Lenders' Agent.
- F. The Lenders' Agent has agreed to enter into this lenders' direct agreement (the "**Lenders' Direct Agreement**") with Contracting Authority in relation to the Security, the exercise of its rights under the Security Documents and the remedying of breaches by Project Co under the Project Agreement.
- G. With a view to ensuring that Contracting Authority is able to properly and effectively discharge its duties, functions and responsibilities under Applicable Law, Project Co, the Lenders' Agent and the Lenders commit to working collaboratively, responsibly and cooperatively with Contracting Authority throughout the Project Term.
- H. IO, as Crown agent and Metrolinx, as Crown agency, intend to enter into this Lenders' Direct Agreement in accordance with Applicable Law, and to be liable, on a joint and several basis, for all of the obligations of Contracting Authority pursuant to this Lenders' Direct Agreement, save and except as provided for in this Lenders' Direct Agreement.

NOW THEREFORE in consideration of the mutual covenants and agreements of the Parties hereinafter contained and for other good and valuable consideration, the receipt and sufficiency of which are hereby acknowledged, the Parties covenant and agree as follows:

1. DEFINITIONS

In this Schedule 4 – Lenders' Direct Agreement, unless the context indicates a contrary intention, terms which are defined in the Project Agreement (and not otherwise defined in this Schedule 4 – Lenders' Direct Agreement) shall have meanings given to them in the Project Agreement and the following terms shall have the following meanings:

- (a) "**Appointed Representative**" means any of the following to the extent so identified in an Appointed Representative Notice:
 - (i) the Lenders' Agent, any Lender or any of their Affiliates;
 - (ii) a receiver or receiver and manager of Project Co appointed under the Security Documents;
 - (iii) a trustee in bankruptcy or court-appointed receiver of Project Co;
 - (iv) an administrator of Project Co;
 - (v) a person directly or indirectly owned or controlled by the Lenders' Agent and/or any of the Lenders; or
 - (vi) any other person approved by Contracting Authority (such approval not to be unreasonably withheld or delayed).
- (b) "**Appointed Representative Notice**" has the meaning given in Section 8(b).

- (c) “**Contracting Authority Project Documents**” means the Project Agreement and all other documents to which both Contracting Authority and Project Co are parties pursuant to or in connection with the Project Agreement.
- (d) “**Default Notice**” has the meaning given in Section 7(b)(i).
- (e) “**Enforcement Action**” means any acceleration of amounts due and owing to the Lenders under any of the Lending Agreements and/or any enforcement proceeding or enforcement action commenced or taken under any of the Security Documents.
- (f) “**Enforcement Event**” means an event of default as defined in the Lending Agreements, or any other event which permits an Enforcement Action.
- (g) “**Exercise Date**” has the meaning given in Section 12(b).
- (h) “**Indebtedness Notice**” has the meaning given in Section 7(b)(ii).
- (i) “**Lender Representative**” means a representative (which may be the Lenders’ Agent) acting as agent or trustee for and on behalf of all of the lenders lending to a Suitable Substitute.
- (j) “**Lenders’ Agent**” means [REDACTED], acting as agent for and on behalf of the Lenders.
- (k) “**Lenders’ Construction Contractor Direct Agreement**” means the direct agreement among the Lenders’ Agent, the Construction Contractor, the Construction Guarantor and Project Co.
- (l) “**Lenders’ Direct Agreement**” means this lenders’ direct agreement.
- (m) “**Notice Period**” means the period starting on the date of delivery of a Default Notice and ending 90 days later.
- (n) “**Novation Date**” has the meaning given in Section 10(a).
- (o) “**Novation Notice**” has the meaning given in Section 10(a).
- (p) “**Party**” means Contracting Authority, Project Co or the Lenders’ Agent, and “**Parties**” means, collectively, Contracting Authority, Project Co and the Lenders’ Agent.
- (q) “**Security**” means the Bonds, the Insurance and any other security interests granted to the Lenders’ Agent pursuant to the Security Documents.
- (r) “**Security Documents**” means [REDACTED].
- (s) “**Step-In Date**” means the date on which Contracting Authority receives a Step-In Notice from the Lenders’ Agent.

- (t) “**Step-In Notice**” means the notice given by the Lenders’ Agent to Contracting Authority pursuant to Section 8(a) stating that the Lenders’ Agent is exercising its step-in rights under this Lenders’ Direct Agreement.
- (u) “**Step-In Period**” means the period from the Step-In Date up to and including the earlier of:
 - (i) the Step-Out Date;
 - (ii) the Termination Date (provided that Contracting Authority has complied with its obligations in Section 7 of this Lenders’ Direct Agreement);
 - (iii) the date that a transfer of Project Co’s rights and obligations under the Contracting Authority Project Documents to a Suitable Substitute pursuant to Section 10 becomes effective; and
 - (iv) if the Step-In Date occurs prior to the Substantial Completion Date, the earlier of:
 - (A) the date falling 120 days after the Longstop Date; or
 - (B) the date falling two years after the Step-In Date.
- (v) “**Step-Out Date**” means the date falling 30 days after the date on which Contracting Authority receives a Step-Out Notice.
- (w) “**Step-Out Notice**” has the meaning given in Section 9(a).
- (x) “**Subsequent Indebtedness Notice**” has the meaning given in Section 7(c).
- (y) “**Suitable Substitute**” means a person, approved in writing by Contracting Authority in accordance with Sections 10(b) and 10(c), which:
 - (i) has the legal capacity, power and authority to become a party to and perform the obligations of Project Co under the Contracting Authority Project Documents; and
 - (ii) employs individuals having the appropriate qualifications, experience and technical competence, and having the resources available to it (including committed financial resources and subcontracts) that are sufficient to enable it to perform the obligations of Project Co under the Contracting Authority Project Documents.

2. INTERPRETATION

This Lenders’ Direct Agreement shall be interpreted according to the following provisions, unless the context requires a different meaning:

- (a) The headings in this Lenders’ Direct Agreement are for convenience of reference only, shall not constitute a part of this Lenders’ Direct Agreement, and shall not be taken into

consideration in the interpretation of, or affect the meaning of, this Lenders' Direct Agreement.

- (b) Unless the context otherwise requires, references to specific Sections, Clauses, Paragraphs, Subparagraphs, and other divisions are references to such Sections, Clauses, Paragraphs, Subparagraphs, or divisions of this Lenders' Direct Agreement and the terms "Section" and "Clause" are used interchangeably and are synonymous.
- (c) Words importing persons or parties are to be broadly interpreted and include an individual, corporation, limited liability company, joint stock company, firm, partnership, joint venture, trust, unincorporated organization, Governmental Authority, unincorporated body of persons or association and any other entity having legal capacity, and the heirs, beneficiaries, executors, administrators or other legal representatives of a person in such capacity.
- (d) Unless the context otherwise requires, wherever used herein the plural includes the singular, the singular includes the plural, and each of the masculine, feminine and neuter genders include all other genders.
- (e) References to any standard, principle, agreement or document include (subject to all relevant approvals and any other provisions of this Lenders' Direct Agreement concerning amendments) a reference to that standard, principle, agreement or document as amended, supplemented, restated, substituted, replaced, novated or assigned.
- (f) The words in this Lenders' Direct Agreement shall bear their natural meaning.
- (g) References containing terms such as:
 - (i) "hereof", "herein", "hereto", "hereinafter", and other terms of like import are not limited in applicability to the specific provision within which such references are set forth but instead refer to this Lenders' Direct Agreement taken as a whole; and
 - (ii) "includes" and "including", whether or not used with the words "without limitation" or "but not limited to", shall not be deemed limited by the specific enumeration of items but shall, in all cases, be deemed to be without limitation and construed and interpreted to mean "includes without limitation" and "including without limitation".
- (h) In construing this Lenders' Direct Agreement, the rule known as the *ejusdem generis rule* shall not apply nor shall any similar rule or approach to the construction of this Lenders' Direct Agreement and, accordingly, general words introduced or followed by the word "other" or "including" or "in particular" shall not be given a restrictive meaning because they are followed or preceded (as the case may be) by particular examples intended to fall within the meaning of the general words.
- (i) Where this Lenders' Direct Agreement states that an obligation shall be performed "no later than" or "within" or "by" a stipulated date or event which is a prescribed number of days after a stipulated date or event, the latest time for performance shall be 5:00 p.m. on

the last day for performance of the obligation concerned, or, if that day is not a Business Day, 5:00 p.m. on the next Business Day.

- (j) Where this Lenders' Direct Agreement states that an obligation shall be performed "on" a stipulated date, the latest time for performance shall be 5:00 p.m. on that day, or, if that day is not a Business Day, 5:00 p.m. on the next Business Day.
- (k) Any reference to time of day or date means the local time or date in Toronto, Ontario.
- (l) Unless otherwise indicated, time periods will be strictly construed.
- (m) Whenever the terms "will" or "shall" are used in this Lenders' Direct Agreement they shall be construed and interpreted as synonymous and to read "shall".

3. CONFLICT OF DOCUMENTS

In the event of any ambiguity, conflict or inconsistency between the provisions of this Lenders' Direct Agreement, the Project Agreement and the Construction Contractor's Direct Agreement, the provisions of this Lenders' Direct Agreement shall prevail and govern to the extent of such ambiguity, conflict or inconsistency.

4. TERM

- (a) This Lenders' Direct Agreement shall terminate automatically on the earliest of:
 - (i) the date on which all amounts which may be or become owing to the Lenders under the Lending Agreements have been irrevocably paid in full;
 - (ii) the Termination Date (provided that Contracting Authority has complied with its obligations in Section 7 of this Lenders' Direct Agreement); and
 - (iii) the date that any transfer of Project Co's rights and obligations under the Contracting Authority Project Documents to a Suitable Substitute pursuant to Section 10 becomes effective and the agreements contemplated in Section 10(e)(iii) are executed and delivered by the parties thereto.
- (b) Within 30 days following its occurrence, the Lenders' Agent shall provide notice to Contracting Authority of the date referred to in Section 4(a)(i).

5. AGREEMENTS AND SECURITY

- (a) Project Co and the Lenders' Agent shall not amend or modify the Lending Agreements, or any of them, except where Project Co is permitted to do so pursuant to Section 8.3 of the Project Agreement.
- (b) Project Co shall not, prior to the Substantial Completion Date, exercise any rights of voluntary prepayment, voluntary redemption, or other voluntary repayment of loan, as applicable, under the Lending Agreements without the prior written consent of Contracting Authority, acting in its sole discretion. In exercising its sole discretion to grant consent,

Contracting Authority shall be entitled to request and consider, and Project Co shall be required to provide within 10 Business Days following a request by Contracting Authority, amongst other things and not limited to, the following:

- (i) written certification by an officer of Project Co of the remaining Project Costs (as defined in the Lending Agreements) accrued and unpaid or expected to be incurred to achieve Interim Completion and Substantial Completion and to fund any Project Accounts (as defined in the Lending Agreements) then not funded and required to be funded at or prior to the then anticipated prepayment and/or redemption (as approved by the Finance Parties' Technical Advisor (as defined in the Lending Agreements) by the Interim Completion and Substantial Completion Date;
 - (ii) written certification by an officer of Project Co that no Funding Shortfall (as defined in the Lending Agreements) would reasonably be expected to arise as a consequence of such prepayment and/or redemption, including any related cancellation of unutilized commitments, if applicable, under the Lending Agreements;
 - (iii) written confirmation from the Lenders' technical advisor, addressed to Contracting Authority, that the Project Co's calculation in Section 5(b)(i) and Project Co's certification in Section 5(b)(ii) is, in the opinion of the Lenders' technical advisor, correct;
 - (iv) written confirmation from the Lenders' technical advisor, addressed to Contracting Authority, that no incremental delay in achieving the Interim Completion Date (beyond the Scheduled Interim Completion Date) or Substantial Completion Date (beyond the Scheduled Substantial Completion Date) would reasonably be expected as a consequence of such prepayment and/or redemption and related cancellation of unutilized commitments, if applicable, under the Lending Agreements; and
 - (v) written confirmation from the Lenders' technical advisor, addressed to Contracting Authority, that the Interim Completion Date is likely to occur on or prior to the then Scheduled Interim Completion Date and the Substantial Completion Date is likely to occur on or prior to the then Scheduled Substantial Completion Date.
- (c) Project Co acknowledges and consents to the arrangements set out in this Lenders' Direct Agreement, and agrees not to do or omit to do anything that may prevent any other Party from enforcing its rights under this Lenders' Direct Agreement.
 - (d) The Lenders' Agent acknowledges having received a copy of the Project Agreement.
 - (e) Contracting Authority acknowledges having received copies of the Lending Agreements, and confirm that they are in form and substance satisfactory to Contracting Authority as at the date of Financial Close.
 - (f) Contracting Authority acknowledges notice of and consents to the Security, and confirm that they have not received notice of any other security interest granted over Project Co's rights under any of the Contracting Authority Project Documents.

- (g) Project Co and the Lenders' Agent hereby authorize and instruct Contracting Authority (and Contracting Authority agrees) to pay all sums payable to Project Co under the Project Agreement: (i) in respect of Milestone Payments, Substantial Completion Payments, Completion Holdback and any Compensation Payment, to Account No. [REDACTED], and (ii) in respect of Project Payments (as defined in the Credit Agreement), other than those mentioned in (i) above, to Account No. [REDACTED]; and Project Co and Contracting Authority agree that upon the occurrence of an Enforcement Event, if so directed in writing by the Lenders' Agent upon giving reasonable notice, Contracting Authority shall pay any sum which they are obliged to pay to Project Co under the Project Agreement to a bank account specified by the Lenders' Agent.
- (h) Prior to the irrevocable payment in full of all amounts owing to the Lenders under the Lending Agreements, Contracting Authority shall not take any action to wind-up, liquidate, dissolve or appoint a receiver or receiver and manager of Project Co or to institute or sanction a voluntary arrangement or any other bankruptcy or insolvency proceedings in relation to Project Co.
- (i) The Lenders' Agent shall appoint the Lenders' Consultant who shall be responsible to advise the Lenders' Agent and the Lenders with respect to the amount of any Legislative Holdback to be maintained in accordance with the Project Agreement. Project Co agrees that it shall, in respect of all payments under the Project Agreement, comply with Part IV of the Construction Act. The Lenders' Agent shall cause the Lenders' Consultant to provide Contracting Authority with a copy of any written assessment or report prepared by the Lenders' Consultant in relation to the status or progress of the Works under the Design and Construction Contract, including but not limited to, any certificate of payment, concurrently with its delivery to the Lenders' Agent. The Lenders' Agent acknowledges and agrees that this Section 5(i) shall constitute sufficient authority for the Lenders' Consultant to provide, without delay, a copy of any and all of its written assessments and reports to Contracting Authority.

6. ENFORCEMENT OF SECURITY BY LENDERS' AGENT

- (a) The Lenders' Agent shall promptly notify Contracting Authority of any Enforcement Event, any Enforcement Action, any notice from the Lenders to Project Co to accelerate the maturity of any amounts owing by Project Co to the Lenders under the Lending Agreements or any notice from the Lenders to Project Co to demand repayment of any amounts owing by Project Co to the Lenders under the Lending Agreements.
- (b) The Lenders' Agent may assign, transfer or otherwise dispose of any right, title or interest it may have in, or rights or obligations it may have pursuant to, the Security Documents to a successor agent in accordance with the terms of the Lending Agreements except where:
 - (i) such assignment, transfer or other disposition would constitute a Refinancing and the provisions of Schedule 28 - Refinancing to the Project Agreement have not been complied with in connection therewith; or
 - (ii) the person to whom such assignment, transfer or other disposition is to be made, or an Affiliate of such person, is a Restricted Person or a person whose standing or activities may compromise (i) Contracting Authority's reputation or integrity, or

(ii) the nature of the public transit system in the Municipality or the Province of Ontario so as to affect public confidence in the public transit system in the Municipality, the Province of Ontario or the Project.

- (c) Any Lender may assign, transfer or otherwise dispose of any right, title or interest it may have in, or rights or obligations it may have pursuant to, the Lending Agreements in accordance with the terms of the Lending Agreements.

7. TERMINATION OF PROJECT AGREEMENT BY CONTRACTING AUTHORITY

- (a) Subject only to the rights expressly afforded to the Lenders' Agent pursuant to, and the restrictions set forth in, this Section 7, Contracting Authority may, at any time, serve Notice terminating the Project Agreement if it is entitled to do so under the terms of the Project Agreement.
- (b) At any time other than during the Step-In Period (with the restriction on termination during the Step-In Period set out in Section 7(d)), Contracting Authority shall not exercise any right it may have to terminate or serve Notice terminating the Project Agreement for a Project Co Event of Default unless:
- (i) Contracting Authority promptly delivers written notice (a “**Default Notice**”) to the Lenders' Agent setting out the Project Co Event of Default in reasonable detail;
 - (ii) not later than 30 days after the date of a Default Notice, Contracting Authority delivers written notice (an “**Indebtedness Notice**”) to the Lenders' Agent setting out:
 - (A) all amounts owed by Project Co to Contracting Authority and any other existing liabilities and unperformed obligations of Project Co to Contracting Authority of which Contracting Authority is aware (having made reasonable enquiry), in each case, as of the date on which Contracting Authority sent the Default Notice; and
 - (B) all amounts which will become owing by Project Co to Contracting Authority and any other liabilities and obligations of Project Co to Contracting Authority of which Contracting Authority is aware (having made reasonable enquiry), in each case, on or before the end of the Notice Period; and
 - (iii) the Notice Period has expired and the Lenders' Agent has not delivered a Step-In Notice.
- (c) At any time after Contracting Authority sends an Indebtedness Notice but before Contracting Authority receives a Step-In Notice, if Contracting Authority discovers amounts that have become owing by Project Co to Contracting Authority or any other liabilities or obligations of Project Co to Contracting Authority that have come due but which were not included in the Indebtedness Notice, Contracting Authority shall deliver written notice (a “**Subsequent Indebtedness Notice**”) to the Lenders' Agent setting out those amounts, liabilities or obligations.

- (d) During the Step-In Period, Contracting Authority shall not terminate the Project Agreement on grounds:
 - (i) that the Lenders' Agent has served a Step-In Notice or enforced any Security Document; or
 - (ii) arising prior to the Step-In Date of which Contracting Authority was aware (having made due inquiry) and whether or not continuing at the Step-In Date unless:
 - (A) the grounds arose prior to the Substantial Completion Date, and the Substantial Completion Date does not occur on or before the date falling 120 days after the Longstop Date; or
 - (B) the grounds (whenever they first arose) did not give rise to any right to terminate the Project Agreement until after the Step-In Date; or
 - (iii) arising solely in relation to Project Co.
- (e) Contracting Authority shall be entitled to terminate the Project Agreement by written Notice to Project Co and the Appointed Representative:
 - (i) if any amount referred to in Section 7(b)(ii)(A) has not been paid to Contracting Authority on or before the Step-In Date;
 - (ii) if any amount referred to in Section 7(b)(ii)(B) has not been paid on or before the last day of the Notice Period;
 - (iii) if amounts included in a Subsequent Indebtedness Notice have not been paid on or before the date falling 30 days after the date on which the Subsequent Indebtedness Notice is delivered to the Lenders' Agent; or
 - (iv) on grounds arising after the Step-In Date in accordance with the terms of the Project Agreement.

8. STEP-IN RIGHTS

- (a) Subject to Section 8(b) and without prejudice to rights of the Lenders' Agent to enforce the Security, the Lenders' Agent may give Contracting Authority a Step-In Notice at any time:
 - (i) during which a Project Co Event of Default is subsisting (whether or not a Default Notice has been served);
 - (ii) during the Notice Period; or
 - (iii) during which an Enforcement Event is subsisting.

- (b) At least five Business Days before the Lenders' Agent delivers a Step-In Notice, the Lenders' Agent shall deliver written notice (an "**Appointed Representative Notice**") to Contracting Authority of:
 - (i) its intention to deliver a Step-In Notice; and
 - (ii) the identity of its proposed Appointed Representative.
- (c) Upon issuance of a Step-In Notice, the Appointed Representative shall assume, jointly with Project Co, all of Project Co's rights under the Contracting Authority Project Documents.
- (d) During the Step-In Period, Contracting Authority shall deal with the Appointed Representative instead of Project Co in connection with all matters related to the Contracting Authority Project Documents. Project Co agrees to be bound by all such dealings between Contracting Authority and the Appointed Representative to the same extent as if they had been between Contracting Authority and Project Co.

9. STEP-OUT RIGHTS

- (a) The Appointed Representative may, at any time during the Step-In Period, deliver written notice (a "**Step-Out Notice**") to Contracting Authority to terminate the Step-In Period on the Step-Out Date.
- (b) On expiry of the Step-In Period:
 - (i) the rights and obligations of the Appointed Representative in relation to Contracting Authority under the Contracting Authority Project Documents arising prior to the expiry of the Step-In Period will be assumed by Project Co to the exclusion of the Appointed Representative;
 - (ii) Contracting Authority will no longer deal with the Appointed Representative and will deal with Project Co in connection with all matters related to the Contracting Authority Project Documents; and
 - (iii) the Appointed Representative and Contracting Authority shall be and hereby are released from all obligations and liabilities to one another under the Contracting Authority Project Documents.
- (c) There will not be more than one Step-In Period in respect of any one Default Notice.

10. NOVATION TO SUITABLE SUBSTITUTE

- (a) Subject to Section 10(b), at any time:
 - (i) after an Enforcement Event has occurred;
 - (ii) during the Notice Period; or
 - (iii) during the Step-In Period,

the Lenders' Agent may deliver to Contracting Authority and any Appointed Representative written notice (a "**Novation Notice**") that it wishes to transfer Project Co's rights and obligations under the Contracting Authority Project Documents to a proposed transferee, together with all information reasonably necessary for Contracting Authority to decide whether the proposed transferee is a Suitable Substitute. The Novation Notice shall specify a Business Day not less than 30 days from the date on which Contracting Authority receives the Novation Notice ("**Novation Date**") for the transfer of Project Co's rights and obligations under the Contracting Authority Project Documents to the proposed transferee in accordance with the provisions of Section 10(e).

- (b) Contracting Authority shall promptly notify the Lenders' Agent of any additional information it requires in order to assess whether the proposed transferee is a Suitable Substitute. Contracting Authority shall notify the Lenders' Agent, in writing, as to whether the person to whom the Lenders' Agent proposes to transfer Project Co's rights and liabilities under the Contracting Authority Project Documents is approved by Contracting Authority as a Suitable Substitute, on or before the date falling 30 days after the later of the date of receipt by Contracting Authority of the Novation Notice and the date of receipt of any additional information requested by Contracting Authority. For greater certainty, if Contracting Authority fails to respond within such period, Contracting Authority shall be deemed not to have approved the proposed transferee.
- (c) Contracting Authority shall not unreasonably withhold or delay its approval of a proposed transferee as a Suitable Substitute, but it shall, without limitation, be reasonable for Contracting Authority to withhold its approval if:
 - (i) there are unremedied breaches under the Project Agreement which are capable of being remedied by the Appointed Representative or the Suitable Substitute and there is no rectification plan acceptable to Contracting Authority, acting reasonably, in respect of such breaches;
 - (ii) the proposed transferee is a Restricted Person or other person who is not permitted to be a Project Co Party pursuant to the Project Agreement; or
 - (iii) the proposed security interests to be granted by the Suitable Substitute to the Lender Representative are materially different from the Security, materially adversely affect the ability of the Suitable Substitute to perform under the Contracting Authority Project Documents or have the effect of increasing any liability of Contracting Authority, whether actual or potential.
- (d) If Contracting Authority withholds its approval of a proposed transferee as a Suitable Substitute in accordance with Section 10(c), the Lenders' Agent may give one or more subsequent Novation Notices pursuant to the provisions of Section 10(a) containing changed particulars relating to the same proposed transferee or particulars relating to another proposed transferee which the Lenders' Agent has good cause to believe will be acceptable to Contracting Authority, acting reasonably, provided that only one Novation Notice may be outstanding at any one time.
- (e) On the Novation Date:

- (i) Project Co and Contracting Authority will be released from their obligations under the Contracting Authority Project Documents to each other, and the Suitable Substitute and Contracting Authority will assume those same obligations towards each other;
- (ii) each of the rights of Project Co against Contracting Authority under the Contracting Authority Project Documents and the rights of Contracting Authority against Project Co under the Contracting Authority Project Documents will be cancelled, and the Suitable Substitute and Contracting Authority will acquire those same rights against each other;
- (iii) the Parties will enter into, and the Lenders' Agent shall cause the Suitable Substitute and the Lender Representative to enter into, all such agreements or other documents as are reasonably necessary to give effect to the foregoing, including:
 - (A) an agreement between Contracting Authority and the Suitable Substitute, on substantially the same terms as the Project Agreement; and
 - (B) an agreement among Contracting Authority, the Suitable Substitute and the Lender Representative on substantially the same terms as this Lenders' Direct Agreement;
- (iv) any subsisting ground for termination by Contracting Authority of the Project Agreement will be deemed to have no effect and any subsisting Default Notice will be automatically revoked.

11. TRANSFERS

Contracting Authority shall, at Project Co's cost and expense, take whatever action the Lenders' Agent, the Appointed Representative or a Suitable Substitute may reasonably require for perfecting any assumption or transfer of or release pursuant to Sections 8, 9 or 10, including the execution of any transfer or assignment, and the giving of any notice, order or direction and the making of any registration which, in each case, the Lenders' Agent, the Appointed Representative or the Suitable Substitute reasonably requires.

12. CONSTRUCTION CONTRACTOR'S DIRECT AGREEMENT

- (a) Notwithstanding any provision in the Construction Contractor's Direct Agreement, Contracting Authority hereby undertake that it will not exercise any rights they may have under or arising out of any of the Construction Contractor's Direct Agreement, except as provided in Sections 12(b) to 12(f) inclusive.
- (b) Following termination of the Project Agreement (other than as a result of a novation pursuant to this Lenders' Direct Agreement) in accordance with this Lenders' Direct Agreement, Contracting Authority shall from such date (the "**Exercise Date**") be entitled to exercise its rights under the Construction Contractor's Direct Agreement to step in to and/or novate the Design and Construction Contract in accordance with the Construction Contractor's Direct Agreement.

- (c) Following the Exercise Date, Contracting Authority shall not do anything to prejudice the rights which are not transferred to them pursuant to the Construction Contractor's Direct Agreement.
- (d) Where all amounts which may be or become owing by Project Co to the Lenders under the Lending Agreements have been irrevocably paid in full, the Lenders' Agent shall promptly release and discharge all Security in respect of the Design and Construction Contract assumed or novated by Contracting Authority pursuant to the Construction Contractor's Direct Agreement.
- (e) Notwithstanding the terms of the Construction Contractor's Direct Agreement and any other provisions of this Section 12, the Construction Contractor (and any guarantor thereof) shall remain responsible, and be liable, to Project Co in respect of all costs, claims, damages, losses and liabilities which shall have arisen out of or in connection with the Design and Construction Contract in respect of the period prior to the Exercise Date.
- (f) Without prejudice to Sections 12(a) to 12(e) inclusive, Contracting Authority shall not, prior to the date on which this Lenders' Direct Agreement terminates:
 - (i) claim, recover, retain or receive (or seek to claim, recover, retain or receive) any amount under the Construction Contractor's Direct Agreement (and/or the Design and Construction Contract) from the Construction Contractor;
 - (ii) take any action to wind-up, liquidate, dissolve or appoint a receiver or receiver and manager of the Construction Contractor or to institute or sanction a voluntary arrangement or any other bankruptcy or insolvency proceedings in relation to the Construction Contractor; or
 - (iii) compete with the rights of the Lenders' Agent on a winding-up or other insolvency or bankruptcy of the Construction Contractor, nor claim to be subrogated to any rights of the Lenders' Agent or any Lender.

Contracting Authority agrees and undertakes that if it receives any amount in contravention of the provisions of this Section 12(f), it will immediately turn the same over to the Lenders' Agent for the account of the Lenders' Agent and the Lenders and, pending such payment, hold the same in trust for the Lenders' Agent and the Lenders.

13. SUBCONTRACTOR'S DIRECT AGREEMENT

Notwithstanding any provision in a Subcontractor's Direct Agreement, Contracting Authority hereby undertakes that it will not exercise any rights they may have under or arising out of any Subcontractor's Direct Agreement unless:

- (a) the Project Agreement and the Design and Construction Contract have been terminated;
- (b) Contracting Authority is entitled to terminate the Project Agreement pursuant to the terms thereof and of this Lender's Direct Agreement; or

- (c) Contracting Authority is entitled to exercise its rights under the Construction Contractor's Direct Agreement pursuant to Section 12(b).

14. PERFORMANCE GUARANTEE OF CONSTRUCTION GUARANTOR

Notwithstanding any provision in the Performance Guarantee of Construction Guarantor, Contracting Authority hereby undertakes that it will not exercise any rights it may have under or arising out of the Performance Guarantee of Construction Guarantor unless:

- (a) the Project Agreement has been terminated; or
- (b) Contracting Authority is entitled to terminate the Project Agreement pursuant to the terms thereof and of this Lenders' Direct Agreement.

15. NOTICE OF PROJECT CO DELAY OR PROCEEDING AT RISK

- (a) The Parties acknowledge that, if Project Co is deemed to be failing to maintain the schedule pursuant to Section 14.1(a) of Schedule 12 – Works Schedule Requirements, Contracting Authority may, in its sole discretion, give notice to the Lenders' Agent that Project Co is failing to maintain the schedule, together with the relevant information supporting Contracting Authority's opinion that Project Co is failing to maintain the schedule.
- (b) The Parties acknowledge that, if Contracting Authority delivers Notice to Project Co in relation to Sections 14.1(a)(i), 14.1(a)(ii) or 14.1(a)(iii) of Schedule 12 – Works Schedule Requirements, Contracting Authority may, in its sole discretion, give notice to the Lenders' Agent that it has delivered such Notice to Project Co, together with the relevant information supporting Contracting Authority's reasons for delivering such Notice to Project Co.
- (c) The Parties acknowledge that if the Independent Certifier determines Project Co is Proceeding at Risk pursuant to Section 14.6(f) of the Project Agreement, Contracting Authority may, in its sole discretion, give notice to the Lenders' Agent that Project Co is Proceeding at Risk, together with a copy of the Independent Certifier's written opinion provided pursuant to such Section of the Project Agreement.

16. ASSIGNMENT

- (a) No Party to this Lenders' Direct Agreement may assign, transfer or otherwise dispose of any part of its rights or obligations under this Lenders' Direct Agreement save as provided in this Section 16.
- (b) Project Co may assign, transfer or otherwise dispose of the benefit of this Lenders' Direct Agreement to any person to whom Project Co assigns, transfers or otherwise disposes of its interest in the Project Agreement pursuant to Section 49.1 of the Project Agreement and the provisions of the Lending Agreements, and shall provide written Notice to Contracting Authority and the Lenders' Agent of such assignment, transfer or other disposition. Such assignee, as a condition precedent to any such assignment, transfer or other disposition, shall assume the obligations and acquire the rights of Project Co under this Lenders' Direct Agreement pursuant to an assumption agreement with, and in form and substance satisfactory to, Contracting Authority and the Lenders' Agent, each acting reasonably.

Contracting Authority and the Lenders' Agent shall, at Project Co's cost and expense, do all things and execute all further documents as may be necessary in connection therewith.

- (c) Contracting Authority may assign, transfer or otherwise dispose of the benefit of the whole or part of this Lenders' Direct Agreement to any person to whom Contracting Authority assigns, transfers or otherwise disposes of its interest in the Project Agreement pursuant to Section 49.2 of the Project Agreement, and shall provide written Notice to Project Co and the Lenders' Agent of such assignment, transfer or other disposition.
- (d) The Lenders' Agent may only assign, transfer or otherwise dispose of any interest in this Lenders' Direct Agreement as permitted by the Lending Agreements, and shall provide written notice to Project Co and Contracting Authority of such assignment, transfer or other disposition; provided that, notwithstanding any provision to the contrary in the Lending Agreements, the Lenders' Agent may not assign, transfer or otherwise dispose of any interest in this Lenders' Direct Agreement to a Restricted Person. The Lenders' Agent, as a condition precedent to any such assignment, transfer or other disposition, shall cause the assignee to enter into a new agreement with Project Co and Contracting Authority on substantially the same terms as this Lenders' Direct Agreement and Project Co and Contracting Authority shall enter into such new agreement with the assignee. Project Co and Contracting Authority shall, at the Lenders' Agent's cost and expense, do all things and execute all further documents as may be necessary in connection therewith.

17. NOTICES

- (a) All notices, requests, demands, instructions, certificates, consents and other communications required or permitted under this Lenders' Direct Agreement shall be in writing (whether or not "written notice" or "notice in writing" is specifically required by the applicable provision of this Lenders' Direct Agreement) and served by sending the same by registered mail or by hand (in each case, with a copy by electronic submission), as follows:

If to Contracting Authority:

Metrolinx
50 Bay Street
Toronto, Ontario M5J 3A5

Fax No.: [REDACTED]
Attn.: [REDACTED]

With a copy to:

Ontario Infrastructure and Lands Corporation
777 Bay Street, 6th Floor
Toronto, Ontario
M5G 2C8

Fax No.: [REDACTED]
Attn.: [REDACTED]

If to the Lenders' Agent:

[REDACTED]

Fax No.: **[REDACTED]**

Email: **[REDACTED]**

Attn.: **[REDACTED]**

If to Project Co:

[REDACTED]

Fax No.: **[REDACTED]**

Email: **[REDACTED]**

Attn.: **[REDACTED]**

with a copy to:

Email: **[REDACTED]**

Attn.: **[REDACTED]**

If to the Construction Guarantor:

[REDACTED]

Fax No.: **[REDACTED]**

Attn.: **[REDACTED]**

with a copy to:

Email: **[REDACTED]**

Attn.: **[REDACTED]**

- (b) Any Party to this Lenders' Direct Agreement may, from time to time, change any of its contact information set forth in Section 17(a) by prior notice to the other Parties, and such change shall be effective on the Business Day that next follows the recipient Party's receipt of such notice unless a later effective date is given in such notice.
- (c) Subject to Sections 17(d) and 17(e):
 - (i) a notice given by registered mail shall be deemed to have been received on the third Business Day after mailing; and
 - (ii) a notice given by hand delivery shall be deemed to have been received on the day it is delivered.
- (d) If the Party giving the notice knows or ought reasonably to know of difficulties with the postal system which might affect negatively the delivery of mail, any such notice shall not be mailed but shall be made by personal delivery in accordance with this Section 17.

- (e) If any notice delivered by hand is so delivered either on a day that is not a Business Day or on a Business Day after 4:00 p.m. (recipient's local time), then such notice shall be deemed to have been received by such recipient on the next following Business Day.

18. CONTRACTING AUTHORITY DESIGNATE

At any time and from time to time, the Crown may designate any ministry, branch, agency, division, department or office of the Government of Ontario to carry out administrative responsibility for the rights and obligations of Contracting Authority under this Lenders' Direct Agreement and Project Co and the Lenders' Agent may deal exclusively with the designated person in respect of all such matters and is entitled to rely on the actions, directions, requests, notices, consents, approvals, waivers, comments relating to the review of documentation and other administrative matters and decisions determined by such designated person from time to time, until the Crown has notified Project Co and the Lenders' Agent in writing that such designated person is no longer the person designated by the Crown hereunder and such notice shall have effect on the later of the date of delivery of such notice and the date specified in the written notice. The Crown shall advise Project Co and the Lenders' Agent in writing of any designation hereunder. The rights and obligations of the parties to this Lenders' Direct Agreement shall be in no way affected by reason of any such designation. Project Co and the Lenders' Agent acknowledge the right of the Crown to delegate administrative responsibilities hereunder as set forth in this Section 18.

19. AMENDMENTS

This Lenders' Direct Agreement may not be varied, amended or supplemented except by an agreement in writing signed by duly authorized representatives of the Parties and stating on its face that it is intended to be an amendment, restatement or other modification, as the case may be, to this Lenders' Direct Agreement.

20. WAIVER

- (a) No waiver made or given by a Party under or in connection with this Lenders' Direct Agreement shall be binding or effective unless the waiver is in writing, signed by an authorized representative of the Party giving such waiver, and delivered by such Party to the other Parties. No waiver made with respect to any right, power or remedy in one instance will be deemed to be a waiver with respect to any other instance involving the exercise of such right, power, or remedy or with respect to any other right, power, or remedy.
- (b) Failure by any Party to exercise any of its rights, powers or remedies hereunder or its delay to do so shall not constitute a waiver of those rights, powers or remedies. The single or partial exercise of a right, power or remedy shall not prevent its subsequent exercise or the exercise of any other right, power or remedy.

21. RELATIONSHIP BETWEEN THE PARTIES

The Parties are independent contractors. This Lenders' Direct Agreement is not intended to and does not create or establish between the Parties any relationship as partners, joint venturers, employer and employee, master and servant, or, except as provided in this Lenders' Direct Agreement, of principal and agent.

22. ENTIRE AGREEMENT

Except where provided otherwise in this Lenders' Direct Agreement, this Lenders' Direct Agreement constitutes the entire agreement between the Parties in connection with its subject matter and supersedes all prior representations, communications, negotiations and understandings, whether oral, written, express or implied, concerning the subject matter of this Lenders' Direct Agreement.

23. SEVERABILITY

Each provision of this Lenders' Direct Agreement shall be valid and enforceable to the fullest extent permitted by law. If any provision of this Lenders' Direct Agreement is declared invalid, unenforceable or illegal by the courts of a competent jurisdiction, such provision may be severed and such invalidity, unenforceability or illegality shall not prejudice or affect the validity, enforceability and legality of the remaining provisions of this Lenders' Direct Agreement. If any such provision of this Lenders' Direct Agreement is invalid, unenforceable or illegal, the Parties shall, acting in good faith, promptly negotiate new provisions to eliminate such invalidity, unenforceability or illegality and to restore this Lenders' Direct Agreement as near as possible to its original intent and effect.

24. ENUREMENT

This Lenders' Direct Agreement shall enure to the benefit of, and be binding on, each of the Parties and their respective successors and permitted transferees and assigns.

25. GOVERNING LAW AND JURISDICTION

- (a) This Lenders' Direct Agreement shall be governed by and construed in accordance with the laws of Ontario and the laws of Canada applicable therein and shall be treated in all respects as an Ontario contract, without regard to conflict of laws principles.
- (b) The Parties agree that the courts of the Province of Ontario and all courts competent to hear appeals therefrom shall have exclusive jurisdiction to hear and settle any action, suit, proceeding or dispute in connection with this Lenders' Direct Agreement and hereby irrevocably attorn to the exclusive jurisdiction of such courts.
- (c) Nothing in this Lenders' Direct Agreement affects the rights, protections and immunities of the Crown under the *Proceedings Against the Crown Act* (Ontario).

26. DISPUTE RESOLUTION PROCEDURE

The Parties agree that the dispute resolution procedure provided for in Schedule 27 - Dispute Resolution Procedure to the Project Agreement shall not apply to any dispute under this Lenders' Direct Agreement.

27. FURTHER ASSURANCE

Each Party shall do all things, from time to time, and execute all further documents necessary to give full effect to this Lenders' Direct Agreement.

28. LANGUAGE OF AGREEMENT

Each Party acknowledges having requested and being satisfied that this Lenders' Direct Agreement and related documents be drawn in English. Chacune des parties reconnaît avoir demandé que ce document et ses annexes soient rédigés en anglais et s'en déclare satisfaite.

29. COUNTERPARTS

This Lenders' Direct Agreement may be executed in one or more counterparts. Any single counterpart or a set of counterparts executed, in either case, by all the Parties shall constitute a full, original and binding agreement for all purposes. Counterparts may be executed either in original or faxed form provided that any Party providing its signature in faxed form shall promptly forward to such Party an original signed copy of this Lenders' Direct Agreement which was so faxed.

30. JOINT AND SEVERAL

IO, as Crown agent and Metrolinx, as Crown agency, shall be liable, on a joint and several basis, for all of the obligations of Contracting Authority under this Lenders' Direct Agreement and for each covenant of the other under this Lenders' Direct Agreement

31. CONFIDENTIALITY

The Lenders' Agent agrees to comply with the obligations imposed on Project Co by the provisions of Section 42 of the Project Agreement, *mutatis mutandis*, provided that the Lenders' Agent will be permitted to disclose to any relevant regulatory authority only such Confidential Information (as defined in the Project Agreement) as is necessary for the Lenders' Agent to comply with Applicable Law.

32. COPYRIGHT NOTICE

The Parties acknowledge that Queen's Printer for Ontario is the exclusive owner of copyright in the Project Agreement and this Lenders' Direct Agreement.

[SIGNATURE PAGES IMMEDIATELY FOLLOW]

IN WITNESS WHEREOF the Parties have executed this Lenders' Direct Agreement as of the date first above written.

ONTARIO INFRASTRUCTURE AND LANDS CORPORATION, a Crown agent, continued under the *Ontario Infrastructure and Lands Corporation Act, 2011*

Per: _____
Name:
Title:

Per: _____
Name:
Title:

I/We have authority to bind the corporation.

METROLINX

Per: _____
Name:
Title:

Per: _____
Name:
Title:

I/We have authority to bind the corporation.

[REDACTED]

Per:

Name:
Title:

Per:

Name:
Title:

I/We have authority to bind the corporation.

GCRS DAVENPORT GENERAL PARTNERSHIP,
by its partners:

GCP DAVENPORT INC.

Per: _____

Name: [REDACTED]

Title: [REDACTED]

I have authority to bind the corporation.

GRACORP DAVENPORT INC.

Per: _____

Name: [REDACTED]

Title: [REDACTED]

I have authority to bind the corporation.

SCHEDULE 5
CONSTRUCTION CONTRACTOR’S DIRECT AGREEMENT

THIS AGREEMENT is made as of July 25, 2019

BETWEEN:

ONTARIO INFRASTRUCTURE AND LANDS CORPORATION, a Crown agent, continued under the *Ontario Infrastructure and Lands Corporation Act, 2011*, S.O. 2011

- AND -

METROLINX, a non-share capital corporation continued under the *Metrolinx Act, 2006*, S.O. 2006, c. 16 and a Crown agency in accordance with the *Crown Agency Act*, R.S.O. 1990, c. 48

(collectively, “**Contracting Authority**”)

- AND -

GCRS DAVENPORT GENERAL PARTNERSHIP, [REDACTED]

(“**Project Co**”)

- AND -

[REDACTED]

(the “**Construction Contractor**”)

- AND -

[REDACTED]

(the “**Construction Guarantor**”)

WHEREAS:

- A. Contracting Authority and Project Co have entered into a project agreement (the “**Project Agreement**”), which requires Project Co to enter into, and to cause the Construction Contractor and the Construction Guarantor to enter into, this Construction Contractor’s Direct Agreement with Contracting Authority.
- B. Project Co and the Construction Contractor have entered into the Design and Construction Contract, which requires the Construction Contractor and the Construction Guarantor to enter into this Construction Contractor’s Direct Agreement with Contracting Authority.

- C. IO, as Crown agent and Metrolinx, as Crown agency, intend to enter into this Construction Contractor's Direct Agreement in accordance with Applicable Law, and to be liable, on a joint and several basis, for all of the obligations of Contracting Authority pursuant to this Construction Contractor's Direct Agreement, save and except as provided for in this Construction Contractor's Direct Agreement.

NOW THEREFORE in consideration of the mutual covenants and agreements of the Parties hereinafter contained and for other good and valuable consideration, the receipt and sufficiency of which are hereby acknowledged, the Parties covenant and agree as follows:

1. DEFINITIONS

In this Schedule 5 – Construction Contractor's Direct Agreement, unless the context indicates a contrary intention, terms which are defined in the Project Agreement (and not otherwise defined in this in this Schedule 5 – Construction Contractor's Direct Agreement) shall have meanings given to them in the Project Agreement and the following terms shall have the following meanings:

- (a) **"Default Notice"** has the meaning given in Section 5(a).
- (b) **"Party"** means Contracting Authority, the Construction Contractor, the Construction Guarantor or Project Co, and **"Parties"** means, collectively, Contracting Authority, the Construction Contractor, the Construction Guarantor and Project Co.
- (c) **"Step-In Notice"** has the meaning given in Section 6(a).
- (d) **"Substitute"** has the meaning given in Section 6(a).

2. INTERPRETATION

This Construction Contractor's Direct Agreement shall be interpreted according to the following provisions, unless the context requires a different meaning:

- (a) The headings in this Construction Contractor's Direct Agreement are for convenience of reference only, shall not constitute a part of this Construction Contractor's Direct Agreement, and shall not be taken into consideration in the interpretation of, or affect the meaning of, this Construction Contractor's Direct Agreement.
- (b) Unless the context otherwise requires, references to specific Sections, Clauses, Paragraphs, Subparagraphs, and other divisions are references to such Sections, Clauses, Paragraphs, Subparagraphs, or divisions of this Construction Contractor's Direct Agreement and the terms "Section" and "Clause" are used interchangeably and are synonymous.
- (c) Words importing persons or parties are to be broadly interpreted and include an individual, corporation, limited liability company, joint stock company, firm, partnership, joint venture, trust, unincorporated organization, Governmental Authority, unincorporated body of persons or association and any other entity having legal capacity, and the heirs,

beneficiaries, executors, administrators or other legal representatives of a person in such capacity.

- (d) Unless the context otherwise requires, wherever used herein the plural includes the singular, the singular includes the plural, and each of the masculine, feminine and neuter genders include all other genders.
- (e) References to any standard, principle, agreement or document include (subject to all relevant approvals and any other provisions of this Construction Contractor's Direct Agreement concerning amendments) a reference to that standard, principle, agreement or document as amended, supplemented, restated, substituted, replaced, novated or assigned.
- (f) The words in this Construction Contractor's Direct Agreement shall bear their natural meaning.
- (g) References containing terms such as:
 - (i) "hereof", "herein", "hereto", "hereinafter", and other terms of like import are not limited in applicability to the specific provision within which such references are set forth but instead refer to this Construction Contractor's Direct Agreement taken as a whole; and
 - (ii) "includes" and "including", whether or not used with the words "without limitation" or "but not limited to", shall not be deemed limited by the specific enumeration of items but shall, in all cases, be deemed to be without limitation and construed and interpreted to mean "includes without limitation" and "including without limitation".
- (h) In construing this Construction Contractor's Direct Agreement, the rule known as the *ejusdem generis* rule shall not apply nor shall any similar rule or approach to the construction of this Construction Contractor's Direct Agreement and, accordingly, general words introduced or followed by the word "other" or "including" or "in particular" shall not be given a restrictive meaning because they are followed or preceded (as the case may be) by particular examples intended to fall within the meaning of the general words.
- (i) Where this Construction Contractor's Direct Agreement states that an obligation shall be performed "no later than" or "within" or "by" a stipulated date or event which is a prescribed number of days after a stipulated date or event, the latest time for performance shall be 5:00 p.m. on the last day for performance of the obligation concerned, or, if that day is not a Business Day, 5:00 p.m. on the next Business Day.
- (j) Where this Construction Contractor's Direct Agreement states that an obligation shall be performed "on" a stipulated date, the latest time for performance shall be 5:00 p.m. on that day, or, if that day is not a Business Day, 5:00 p.m. on the next Business Day.

- (k) Any reference to time of day or date means the local time or date in Toronto, Ontario.
- (l) Unless otherwise indicated, time periods will be strictly construed.
- (m) Whenever the terms “will” or “shall” are used in this Construction Contractor’s Direct Agreement they shall be construed and interpreted as synonymous and to read “shall”.

3. CONFLICT IN DOCUMENTS

- (a) In the event of ambiguities, conflicts or inconsistencies between or among this Construction Contractor’s Direct Agreement, the Project Agreement and the Design and Construction Contract, this Construction Contractor’s Direct Agreement shall prevail.
- (b) In the event of ambiguities, conflicts or inconsistencies between or among this Construction Contractor’s Direct Agreement and the Lenders’ Direct Agreement, the Lenders’ Direct Agreement shall prevail.

4. AGREEMENTS

- (a) Project Co and the Construction Contractor shall not amend, modify, or depart from the terms of the Design and Construction Contract without the prior written consent of Contracting Authority, acting reasonably, which consent shall not be withheld or delayed where such amendment, modification or departure does not materially and adversely affect the ability of Project Co to perform its obligations under this Construction Contractor’s Direct Agreement and does not have the effect of increasing any liability of Contracting Authority, whether actual or potential. Project Co and the Construction Contractor shall provide to Contracting Authority a written copy of all such amendments, modifications or departures. The Parties acknowledge and agree that this Section 4(a) shall not apply to Variations provided for under the Project Agreement.
- (b) Each of the Parties acknowledges having received a copy of the Project Agreement and the Design and Construction Contract.
- (c) If the Construction Contractor gives Project Co any notice of any default(s) under the Design and Construction Contract that may give the Construction Contractor a right to terminate the Design and Construction Contract or to treat it as having been repudiated by Project Co or to discontinue the Construction Contractor’s performance thereunder, then the Construction Contractor shall concurrently provide Contracting Authority with a copy of such notice and set out in reasonable detail the default(s).

5. NO TERMINATION BY CONSTRUCTION CONTRACTOR WITHOUT DEFAULT NOTICE

The Construction Contractor shall not exercise any right it may have to terminate the Design and Construction Contract or to treat it as having been repudiated by Project Co or to discontinue the Construction Contractor’s performance thereunder unless:

- (a) the Construction Contractor first delivers a written notice (a “**Default Notice**”) to Contracting Authority setting out in reasonable detail the default(s) on which the Construction Contractor intends to rely in terminating the Design and Construction Contract or to treat it as having been repudiated by Project Co or to discontinue the Construction Contractor’s performance thereunder; and
- (b) within a period of five Business Days of Contracting Authority receiving the Default Notice:
 - (i) the default(s) on which the Construction Contractor intends to rely in terminating the Design and Construction Contract or to treat it as having been repudiated by Project Co or to discontinue the Construction Contractor’s performance thereunder have not been remedied; and
 - (ii) the Construction Contractor has not received a Step-In Notice from Contracting Authority, provided that if, within such period of five Business Days, Contracting Authority agrees to pay the Construction Contractor’s reasonable costs of continued performance, such period of five Business Days shall be extended to 45 days.

6. STEP-IN RIGHTS

- (a) Contracting Authority may at any time:
 - (i) within five Business Days or, if such period has been extended in accordance with Section 5, 45 days of Contracting Authority receiving a Default Notice; or
 - (ii) if Contracting Authority has not received a Default Notice and if Contracting Authority’s right to terminate the Project Agreement has arisen and is continuing,deliver a notice (a “**Step In Notice**”) electing to replace Project Co under the Design and Construction Contract either with Contracting Authority or a third party designated by Contracting Authority in the Step-In Notice (the “**Substitute**”), provided that Contracting Authority can demonstrate to the Construction Contractor, acting reasonably, that the Substitute shall have sufficient financial resources, or shall be supported by a satisfactory guarantee, to carry out the obligations of the Substitute under the Design and Construction Contract.
- (b) Subject to Section 6(d), upon receipt by the Construction Contractor of a Step In Notice:
 - (i) Project Co and the Construction Contractor will be deemed to be released from their existing and future obligations under the Design and Construction Contract to each other (except with respect to any and all indemnities from Project Co or the Construction Contractor to the other in respect of the period prior to the receipt of the Step-In Notice), and Contracting Authority or the Substitute, as applicable, and the Construction Contractor will be deemed to assume those same existing and

- future obligations towards each other (except in respect of the aforesaid indemnities);
- (ii) the existing and future rights of Project Co against the Construction Contractor under the Design and Construction Contract and vice versa will be deemed to be cancelled (except with respect to any and all indemnities from Project Co or the Construction Contractor to the other in respect of the period prior to the receipt of the Step-In Notice), and Contracting Authority or the Substitute, as applicable, and the Construction Contractor will be deemed to acquire those same existing and future rights against each other (except in respect of the aforesaid indemnities), subject to any applicable credit from the Construction Contractor to Contracting Authority if Contracting Authority pays for the Construction Contractor's reasonable costs of continued performance pursuant to Section 5;
 - (iii) any guarantee, bond, covenant, letter of credit or similar performance security in favour of Project Co from any third party in respect of any term, provision, condition, obligation, undertaking or agreement on the part of the Construction Contractor to be performed, observed or carried out by the Construction Contractor as contained in, referred to, or inferred from the Design and Construction Contract shall be assigned, novated or granted, as required by Contracting Authority or the Substitute, as applicable, each acting reasonably, to Contracting Authority or the Substitute, as applicable, and the Construction Contractor shall cause such assignment, novation or grant on substantially the same terms and conditions as the original guarantee, bond, covenant, letter of credit or similar performance security, provided however that where Project Co shall continue to hold, or shall continue to be entitled to or have rights under, such guarantee, bond, covenant, letter of credit or similar performance security, as security for any obligations of the Construction Contractor, the assignment, novation or grant of the guarantee, bond or covenant, letter of credit or similar performance security to the extent of any such obligations to Project Co shall be conditional on the satisfaction of those obligations to Project Co; and
 - (iv) at Contracting Authority's request, the Construction Contractor shall enter into, and shall cause the Construction Guarantor and any other guarantor, covenantor or surety under any guarantee, bond or covenant referred to in Section 6(b)(iii) to enter into, and Contracting Authority shall or shall cause the Substitute to enter into, as applicable, all such agreements or other documents as reasonably necessary to give effect to the foregoing, including an agreement between Contracting Authority or the Substitute, as applicable, and the Construction Contractor, acceptable to Contracting Authority and the Construction Contractor, each acting reasonably, on substantially the same terms as the Design and Construction Contract.
- (c) Subject to Section 6(d), Project Co shall, at its own cost, cooperate fully with Contracting Authority and the Substitute in order to achieve a smooth transfer of the Design and Construction Contract to Contracting Authority or the Substitute, as applicable, and to avoid or mitigate in so far as reasonably practicable any inconvenience, including the

administration of the Design and Construction Contract, ongoing supervisory activities and scheduling.

- (d) The rights granted by Sections 6(b) and 6(c) shall be of no force or effect if, at any time the Construction Contractor receives a Step-In Notice, the Construction Contractor has already received notice in writing from another entity entitled to the benefit of step-in rights relating to the Design and Construction Contract that it is or has validly exercised those step-in rights. If the Construction Contractor receives any such notice on the same day as a Step-In Notice, the Step-In Notice shall be effective, except where the other notice is given by the Lenders, in which case such other notice and not the Step-In Notice shall be effective.
- (e) If Contracting Authority gives a Step-In Notice within the time provided hereunder at any time after the Construction Contractor has terminated the Design and Construction Contract or treated it as having been repudiated by Project Co or discontinued the Construction Contractor's performance thereunder in accordance with the terms of this Construction Contractor's Direct Agreement, the Construction Contractor agrees that the Design and Construction Contract shall be reinstated and deemed to have continued despite any termination or treatment as having been repudiated, and Contracting Authority shall pay the Construction Contractor's reasonable costs for re-commencing the obligations it has under the Design and Construction Contract and the Construction Contractor shall be entitled to reasonable compensation and/or relief for re-commencing such obligations, having regard to the additional costs and delays incurred as a result of having terminated the Design and Construction Contract or having treated it as being repudiated by Project Co or having discontinued its performance thereunder.

7. CONSTRUCTION CONTRACTOR LIABILITY

- (a) The liability of the Construction Contractor hereunder shall not be modified, released, diminished or in any way affected by:
 - (i) any independent inspection, investigation or enquiry into any matter which may be made or carried out by or for Contracting Authority, or by any failure or omission to carry out any such inspection, investigation or enquiry; or
 - (ii) the appointment by Contracting Authority of any other person to review the progress of or otherwise report to Contracting Authority in respect of the Project, or by any action or omission of such person whether or not such action or omission might give rise to any independent liability of such person to Contracting Authority,

provided always that nothing in this Section 7 shall modify or affect any rights which the Construction Contractor might have otherwise had to claim contribution from any other person whether under statute or common law.

- (b) In the event Contracting Authority delivers a Step-In Notice, the Construction Contractor shall have no greater liability to Contracting Authority or any Substitute than it would have

had to Project Co under the Design and Construction Contract, and the Construction Contractor shall be entitled in any proceedings by Contracting Authority or any Substitute to rely on any liability limitations in the Design and Construction Contract.

8. PROJECT CO AS PARTY

Project Co acknowledges and agrees that the Construction Contractor shall not be in breach of the Design and Construction Contract by complying with its obligations hereunder.

9. CONSTRUCTION GUARANTOR AS PARTY

The Construction Guarantor agrees with Contracting Authority that the Construction Guarantor has entered into a guarantee or covenant referred to in Section 6(b)(iii) and hereby consents to the assignment, novation or grant (including any conditional assignment, novation or grant) as provided herein immediately upon receipt by the Construction Contractor of a Step-In Notice and without the requirement of any further action on the part of Contracting Authority, and agrees that the Construction Guarantor shall in accordance with Section 6 enter into all such agreements or other documents as reasonably necessary to give effect to the foregoing. The Construction Guarantor enters into this Construction Contractor's Direct Agreement solely for the purposes of this Section 9.

10. ASSIGNMENT

- (a) Project Co shall not, without the prior written consent of Contracting Authority, assign, transfer, charge, subcontract, subparticipate or otherwise dispose of any interest in this Construction Contractor's Direct Agreement except to the extent entitled to do so under the Project Agreement.
- (b) Contracting Authority may assign or otherwise dispose of the benefit of the whole or part of this Construction Contractor's Direct Agreement to any person to whom Contracting Authority may assign or otherwise dispose of its interest in the Project Agreement pursuant to Section 49.2 of the Project Agreement but only in conjunction therewith, and shall provide written Notice to Project Co and the Construction Contractor of such assignment or disposition.
- (c) The Construction Contractor shall not, without the prior written consent of Contracting Authority and Project Co, assign, transfer, charge, subcontract, subparticipate or otherwise dispose of any interest in this Construction Contractor's Direct Agreement except as may be permitted under the Design and Construction Contract.

11. NOTICES

- (a) All notices, requests, demands, instructions, certificates, consents and other communications required or permitted under this Construction Contractor's Direct Agreement shall be in writing (whether or not "written notice" or "notice in writing" is specifically required by the applicable provision of this Construction Contractor's Direct

Agreement) and served by sending the same by registered mail, facsimile or by hand (in each case, with a copy by electronic submission), as follows:

- (i) If to Contracting Authority:

[REDACTED]

Fax No.: **[REDACTED]**

Attn.: **[REDACTED]**

With a copy to:

[REDACTED]

Fax No.: **[REDACTED]**

Attn.: **[REDACTED]**

- (ii) If to Project Co:

[REDACTED]

Fax No.: **[REDACTED]**

Email: **[REDACTED]**

Attn.: **[REDACTED]**

with a copy to:

Email: **[REDACTED]**

Attn.: **[REDACTED]**

- (iii) If to the Construction Contractor:

[REDACTED]

Fax No.: **[REDACTED]**

Email: **[REDACTED]**

Attn.: **[REDACTED]**

with a copy to:

Email: **[REDACTED]**

Attn.: **[REDACTED]**

- (iv) If to the Construction Guarantor:

[REDACTED]

Fax No.: [REDACTED]
Attn.: [REDACTED]

with a copy to:

Email: [REDACTED]
Attn.: [REDACTED]

- (b) Where any notice is provided or submitted to a Party via facsimile an original of the notice sent via facsimile shall promptly be sent by regular mail or registered mail. For greater certainty, a notice given via facsimile shall not be invalid by reason only of a Party's failure to comply with this Section 11(b).
- (c) Any Party to this Construction Contractor's Direct Agreement may, from time to time, change any of its contact information set forth in Section 11(a) by prior notice to the other Parties, and such change shall be effective on the Business Day that next follows the recipient Party's receipt of such notice unless a later effective date is given in such notice.
- (d) Subject to Sections 11(e), 11(f) and 11(g):
 - (i) a notice given by registered mail shall be deemed to have been received on the third Business Day after mailing;
 - (ii) a notice given by hand delivery shall be deemed to have been received on the day it is delivered; and
 - (iii) a notice given by facsimile shall be deemed to have been received on the day it is transmitted by facsimile.
- (e) If the Party giving the notice knows or ought reasonably to know of difficulties with the postal system which might affect negatively the delivery of mail, any such notice shall not be mailed but shall be made or given by personal delivery or by facsimile transmission in accordance with this Section 11.
- (f) If any notice delivered by hand or transmitted by facsimile is so delivered or transmitted, as the case may be, either on a day that is not a Business Day or on a Business Day after 4:00 p.m. (recipient's local time), then such notice shall be deemed to have been received by such recipient on the next Business Day.
- (g) A notice given by facsimile shall be deemed to have been received by the recipient on the day it is transmitted only if a facsimile transmission report (maintained by the sender) indicates that the transmission of such notice was successful.

12. AMENDMENTS

This Construction Contractor's Direct Agreement may not be varied, amended or supplemented except by an agreement in writing signed by duly authorized representatives of the Parties and

stating on its face that it is intended to be an amendment, restatement or other modification, as the case may be, to this Construction Contractor's Direct Agreement.

13. WAIVER

- (a) No waiver made or given by a Party under or in connection with this Construction Contractor's Direct Agreement shall be binding or effective unless the waiver is in writing, signed by an authorized representative of the Party giving such waiver, and delivered by such Party to the other Parties. No waiver made with respect to any right, power or remedy in one instance will be deemed to be a waiver with respect to any other instance involving the exercise of such right, power, or remedy or with respect to any other right, power, or remedy.
- (b) Failure by any Party to exercise any of its rights, powers or remedies hereunder or its delay to do so shall not constitute a waiver of those rights, powers or remedies. The single or partial exercise of a right, power or remedy shall not prevent its subsequent exercise or the exercise of any other right, power or remedy.

14. RELATIONSHIP BETWEEN THE PARTIES

The Parties are independent contractors. This Construction Contractor's Direct Agreement is not intended to and does not create or establish between the Parties any relationship as partners, joint venturers, employer and employee, master and servant, or, except as provided in this Construction Contractor's Direct Agreement, of principal and agent.

15. ENTIRE AGREEMENT

Except where provided otherwise in this Construction Contractor's Direct Agreement, this Construction Contractor's Direct Agreement constitutes the entire agreement between the Parties in connection with its subject matter and supersedes all prior representations, communications, negotiations and understandings, whether oral, written, express or implied, concerning the subject matter of this Construction Contractor's Direct Agreement.

16. SEVERABILITY

Each provision of this Construction Contractor's Direct Agreement shall be valid and enforceable to the fullest extent permitted by law. If any provision of this Construction Contractor's Direct Agreement is declared invalid, unenforceable or illegal by the courts of a competent jurisdiction, such provision may be severed and such invalidity, unenforceability or illegality shall not prejudice or affect the validity, enforceability and legality of the remaining provisions of this Construction Contractor's Direct Agreement. If any such provision of this Construction Contractor's Direct Agreement is invalid, unenforceable or illegal, the Parties shall, acting in good faith, promptly negotiate new provisions to eliminate such invalidity, unenforceability or illegality and to restore this Construction Contractor's Direct Agreement as near as possible to its original intent and effect.

17. ENUREMENT

This Construction Contractor's Direct Agreement shall enure to the benefit of, and be binding on, each of the Parties and their respective successors and permitted transferees and assigns.

18. GOVERNING LAW AND JURISDICTION

- (a) This Construction Contractor's Direct Agreement shall be governed by and construed in accordance with the laws of Ontario and the laws of Canada applicable therein and shall be treated in all respects as an Ontario contract, without regard to conflict of laws principles.
- (b) The Parties agree that the courts of the Province of Ontario and all courts competent to hear appeals therefrom shall have exclusive jurisdiction to hear and settle any action, suit, proceeding or dispute in connection with this Construction Contractor's Direct Agreement and hereby irrevocably attorn to the exclusive jurisdiction of such courts.
- (c) Nothing in this Construction Contractor's Direct Agreement affects the rights, protections and immunities of the Crown under the Proceedings Against the Crown Act (Ontario).

19. CONTRACTING AUTHORITY DESIGNATE

At any time and from time to time, the Crown may designate any ministry, branch, agency, division, department or office of the Government of Ontario to carry out administrative responsibility for the rights and obligations of Contracting Authority under this Construction Contractor's Direct Agreement and Project Co, the Construction Contractor and the Construction Guarantor may deal exclusively with the designated person in respect of all such matters and is entitled to rely on the actions, directions, requests, notices, consents, approvals, waivers, comments relating to the review of documentation and other administrative matters and decisions determined by such designated person from time to time, until the Crown has notified Project Co, the Construction Contractor and the Construction Guarantor in writing that such designated person is no longer the person designated by the Crown hereunder and such notice shall have effect on the later of the date of delivery of such notice and the date specified in the written notice. The Crown shall advise Project Co, the Construction Contractor and the Construction Guarantor in writing of any designation hereunder. The rights and obligations of the parties to this Construction Contractor's Direct Agreement shall be in no way affected by reason of any such designation. Project Co, the Construction Contractor and each of the Construction Guarantor acknowledge the right of the Crown to delegate administrative responsibilities hereunder as set forth in this Section 19.

20. FURTHER ASSURANCE

Each Party shall do all things, from time to time, and execute all further documents necessary to give full effect to this Construction Contractor's Direct Agreement.

21. LANGUAGE OF AGREEMENT

Each Party acknowledges having requested and being satisfied that this Construction Contractor's Direct Agreement and related documents be drawn in English. Chacune des parties reconnaît avoir demandé que ce document et ses annexes soient rédigés en anglais et s'en déclare satisfaite.

22. COUNTERPARTS

This Construction Contractor's Direct Agreement may be executed in one or more counterparts. Any single counterpart or a set of counterparts executed, in either case, by all the Parties shall constitute a full, original and binding agreement for all purposes. Counterparts may be executed either in original or faxed form provided that any Party providing its signature in faxed form shall promptly forward to such Party an original signed copy of this Construction Contractor's Direct Agreement which was so faxed.

23. JOINT AND SEVERAL

IO, as Crown agent and Metrolinx, as Crown agency, shall be liable, on a joint and several basis, for all of the obligations of Contracting Authority under this Construction Contractor's Direct Agreement and for each covenant of the other under this Construction Contractor's Direct Agreement.

24. COPYRIGHT NOTICE

The Parties acknowledge that Queen's Printer for Ontario is the exclusive owner of copyright in the Project Agreement and this Construction Contractor's Direct Agreement.

[SIGNATURE PAGES IMMEDIATELY FOLLOW]

IN WITNESS WHEREOF the Parties have executed this Construction Contractor’s Direct Agreement as of the date first above written.

METROLINX

By: _____
Name:
Title:

By: _____
Name:
Title:

I/We have the authority to bind the corporation

ONTARIO INFRASTRUCTURE AND LANDS CORPORATION, a Crown agent, continued under the *Ontario Infrastructure and Lands Corporation Act, 2011*

By: _____
Name:
Title:

By: _____
Name:
Title:

I/We have the authority to bind the corporation

GCRS DAVENPORT GENERAL PARTNERSHIP,
by its partners:

GCP DAVENPORT INC.

Per: _____

Name: **[REDACTED]**

Title: **[REDACTED]**

I have authority to bind the corporation.

GRACORP DAVENPORT INC.

Per: _____

Name: **[REDACTED]**

Title: **[REDACTED]**

I have authority to bind the corporation.

[REDACTED]

By: _____

Name: [REDACTED]

Title: [REDACTED]

I have the authority to bind the
corporation

[REDACTED]

By: _____

Name: [REDACTED]

Title: [REDACTED]

I/We have the authority to bind the corporation

SCHEDULE 6

INDEPENDENT CERTIFIER AGREEMENT

THIS AGREEMENT is made as of July 25, 2019

BETWEEN:

ONTARIO INFRASTRUCTURE AND LANDS CORPORATION, a Crown agent, continued under the *Ontario Infrastructure and Lands Corporation Act, 2011*, S.O. 2011

AND:

METROLINX, a non-share capital corporation continued under the *Metrolinx Act, 2006* (Ontario) and a Crown agency in accordance with the *Crown Agency Act* (Ontario)

(collectively, “**Contracting Authority**”)

AND:

GCRS DAVENPORT GENERAL PARTNERSHIP, [REDACTED]

(“**Project Co**”)

AND:

[REDACTED]

(the “**Independent Certifier**”)

WHEREAS:

- A. Contracting Authority and Project Co (collectively, the “**PA Parties**” and each, a “**PA Party**”) have entered into a project agreement (the “**Project Agreement**”).
- B. Pursuant to the terms of the Project Agreement, the PA Parties wish to appoint the Independent Certifier, and the Independent Certifier wishes to accept such appointment, to perform certain services in connection with the Project Agreement.
- C. The PA Parties and the Independent Certifier wish to enter into this Independent Certifier Agreement in order to record the terms by which the Independent Certifier shall perform such services.
- D. IO, as Crown agent and Metrolinx, as Crown agency, intend to enter into this Independent Certifier Agreement in accordance with Applicable Law, and to be liable, on a joint and several basis, for all of the obligations of Contracting Authority pursuant to this Independent Certifier Agreement, save and except as provided for in this Independent Certifier Agreement.

NOW THEREFORE in consideration of the mutual covenants and agreements of the PA Parties and the Independent Certifier herein contained and for other good and valuable consideration, the receipt and sufficiency of which are hereby acknowledged, the PA Parties and the Independent Certifier covenant and agree as follows:

1. DEFINITIONS

1.1 Definitions

- (a) In this Independent Certifier Agreement, including the recitals and appendices, unless the context indicates a contrary intention, terms which are defined in the Project Agreement (and not otherwise defined in this Independent Certifier Agreement) shall have meanings given to them in the Project Agreement and the following terms shall have the following meanings:
- (i) **“Certification Services”** means:
 - (A) all of the functions and obligations described in the Project Agreement as being the responsibility of the Independent Certifier;
 - (B) all of the functions and obligations conferred on the Independent Certifier under this Independent Certifier Agreement, including the functions described in Appendix A to this Independent Certifier Agreement; and
 - (C) all other functions or tasks which the Independent Certifier must do to comply with its obligations under this Independent Certifier Agreement.
 - (ii) **“Certification Services Variation”** is any change to the Certification Services.
 - (iii) **“Contract Material”** means all material:
 - (A) provided to the Independent Certifier or created or required to be created by either PA Party; and
 - (B) provided by or created or required to be created by the Independent Certifier as part of, or for the purpose of, performing the Certification Services,including documents, equipment, reports, technical information, plans, charts, drawings, calculations, tables, schedules and data (stored and recorded by any means).
 - (iv) **“Fee”** means the fees payable by Contracting Authority and Project Co to the Independent Certifier for the Certification Services, as such fees are specified and made payable in accordance with Appendix B to this Independent Certifier Agreement.
 - (v) **“Independent Certifier”** has the meaning given in the preamble.
 - (vi) **“Installed Equipment”** has the meaning given in Appendix A to this Schedule 6.
 - (vii) **“Monthly Report”** has the meaning given in Appendix A to this Schedule 6.

- (viii) “**PA Parties**” means both Contracting Authority and Project Co, and “**PA Party**” means either Contracting Authority or Project Co, as the context requires.
- (ix) “**Quarterly Report**” has the meaning given in Appendix A to this Schedule 6.

2. INTERPRETATION

2.1 Interpretation

- (a) In this Independent Certifier Agreement, unless the context indicates a contrary intention:
 - (i) words denoting the singular number include the plural and vice versa;
 - (ii) words denoting individuals include corporations and vice versa;
 - (iii) headings are for convenience only and do not affect interpretation;
 - (iv) references to Clauses, Sections or Parts are references to Clauses, Sections or Parts of this Independent Certifier Agreement;
 - (v) references to this Independent Certifier Agreement or any contract, agreement or instrument are deemed to include references to this Independent Certifier Agreement or such other contract, agreement or instrument as amended, novated, supplemented, varied or replaced from time to time;
 - (vi) references to any party to this Independent Certifier Agreement includes its successors or permitted assigns;
 - (vii) words denoting any gender include all genders;
 - (viii) references to any legislation or to any section or provision of any legislation include any statutory modification or re-enactment of any statutory provision substituted for legislation, section or provision, and ordinances, by laws, regulations and other statutory instruments issued under that legislation, section or provision;
 - (ix) a reference to “\$” is to Canadian currency;
 - (x) the terms “including” and “include” mean “including” or “include” (as applicable) without limitation;
 - (xi) if a word or phrase is defined, then other parts of speech and grammatical forms of that word or phrase have a corresponding meaning; and
 - (xii) unless otherwise indicated, all time periods will be strictly construed.

2.2 Obligations and Exercise of Rights by PA Parties

- (a) The obligations of the PA Parties under this Independent Certifier Agreement shall be several.

- (b) Except as specifically provided for in this Independent Certifier Agreement or the Project Agreement, the rights of the PA Parties under this Independent Certifier Agreement shall be jointly exercised by the PA Parties.

3. ROLE OF THE INDEPENDENT CERTIFIER

3.1 Engagement

- (a) The PA Parties hereby appoint the Independent Certifier, and the Independent Certifier hereby accepts such appointment, to carry out the Certification Services in accordance with this Independent Certifier Agreement. The Independent Certifier shall perform the Certification Services in accordance with this Independent Certifier Agreement.
- (b) Nothing in this Independent Certifier Agreement will be interpreted as giving the Independent Certifier any responsibility for performance of the design or construction, or for the certifications of the professionals of record.
- (c) Neither PA Party shall, without the prior written consent of the other PA Party, enter into any separate agreement with the Independent Certifier in connection with the Project, and Project Co shall ensure that no Project Co Party enters into any separate agreement with the Independent Certifier in connection with the Project.
- (d) The Independent Certifier shall make such observations and evaluations of any Works pursuant to a Variation in order to certify any monthly progress payment to Project Co of the value of work performed, provided the Independent Certifier shall be entitled to a “Certification Services Variation Order” pursuant to Sections 9.4 and 9.5 of this Independent Certifier Agreement.

3.2 Acknowledgement of Independent Certifier

- (a) The Independent Certifier hereby acknowledges in favour of the PA Parties that it has received a copy of the Project Agreement.

3.3 Standard of Care

- (a) The Independent Certifier must exercise the standard and skill, care and diligence in the performance of the Certification Services that would be expected of an expert professional experienced in providing services in the nature of the Certification Services for projects similar to the Project.

3.4 Duty of Independent Judgment

- (a) In exercising its Certification Services, the Independent Certifier must:
- (i) act impartially, honestly and independently in representing the interests of both PA Parties in accordance with the terms of the Project Agreement and this Independent Certifier Agreement;
 - (ii) act reasonably and professionally;

- (iii) act in a timely manner:
 - (A) in accordance with the times prescribed in this Independent Certifier Agreement and the Project Agreement; or
 - (B) where no times are prescribed, within 10 days or such earlier time so as to enable the PA Parties to perform their respective obligations under the Project Agreement; and
- (iv) act in accordance with the joint directions of the PA Parties provided that the directions are not inconsistent with the other terms of this Independent Certifier Agreement or the terms of the Project Agreement and do not vary or prejudice the Independent Certifier's authority or responsibilities or the exercise by the Independent Certifier of its professional judgment under this Independent Certifier Agreement.
- (b) Although the Independent Certifier may take account of any opinions or representations made by the PA Parties, the Independent Certifier shall not be bound to comply with any opinions or representations made by either of them in connection with any matter on which the Independent Certifier is required to exercise its professional judgment.
- (c) The Independent Certifier acknowledges that the PA Parties may rely on the Certification Services, including determinations, findings and certifications made by the Independent Certifier, and accordingly, the Independent Certifier will use its best skill and judgment in providing the Certification Services.

3.5 Authority to Act

- (a) The Independent Certifier:
 - (i) is an independent consultant and is not, and must not purport to be, a partner, joint venturer or agent of either PA Party;
 - (ii) other than as expressly set out in this Independent Certifier Agreement or the Project Agreement, has no authority to give any directions to a PA Party or its officers, directors, members, employees, contractors, consultants or agents; and
 - (iii) has no authority to waive or alter any terms of the Project Agreement, nor to discharge or release a party from any of its obligations under the Project Agreement unless jointly agreed by the PA Parties in writing.

3.6 Knowledge of the PA Parties' Requirements

- (a) The Independent Certifier warrants that:
 - (i) it has informed and will be deemed to have informed itself fully of the requirements of the Project Agreement;

- (ii) it will inform itself fully of the requirements of such other documents and materials as may become relevant from time to time to the performance of the Certification Services;
- (iii) without limiting Sections 3.6(a)(i) or 3.6(a)(ii), it has and will be deemed to have informed itself fully of all time limits and other requirements for any Certification Service which the Independent Certifier carries out under the Project Agreement and this Independent Certifier Agreement;
- (iv) it has and will be deemed to have informed itself completely of the nature of the work necessary for the performance of the Certification Services and the means of access to and facilities at or on the New Metrolinx Infrastructure, the New Third Party Infrastructure and the Lands including restrictions on any such access or protocols that are required; and
- (v) it has satisfied itself as to the correctness and sufficiency of its proposal for the Certification Services and that the Fee covers the cost of complying with all of the obligations under this Independent Certifier Agreement and of all matters and things necessary for the due and proper performance and completion of the Certification Services.

3.7 Co-ordination and Information by Independent Certifier

- (a) The Independent Certifier must:
 - (i) fully cooperate with the PA Parties and their consultants and advisors;
 - (ii) carefully co-ordinate the Certification Services with the work and services performed by the PA Parties;
 - (iii) without limiting its obligations under Sections 3.4 and 3.7(a)(ii), perform the Certification Services so as to avoid unreasonably interfering with, disrupting or delaying the work and services performed by the PA Parties;
 - (iv) include both PA Parties in all discussions, meetings or any other communications regarding the Project; and
 - (v) provide copies to the PA Parties of all reports, communications, certificates and other documentation that it provides to either PA Party.

3.8 Conflict of Interest

- (a) The Independent Certifier warrants that:
 - (i) at the date of this Independent Certifier Agreement, no conflict of interest exists or is likely to arise in the performance of its obligations under this Independent Certifier Agreement, and the Independent Certifier further warrants that it has not been retained as a technical advisor to the Lenders or as an advisor to either of the PA Parties or any of their respective related entities in respect of the Project Agreement (including, but not limited to, acting as a transaction advisor to either PA Party); and

- (ii) if, during the term of this Independent Certifier Agreement, any such conflict or risk of conflict of interest arises, the Independent Certifier will notify the PA Parties immediately in writing of that conflict or risk of conflict and take such steps as may be required by either of the PA Parties to avoid or mitigate that conflict or risk.

3.9 Independent Certifier Personnel

- (a) The Independent Certifier shall make reasonable efforts to ensure that the individuals listed in Appendix C remain involved in the performance of the Certification Services and, in particular, will not, for the duration of this Independent Certifier Agreement, require any such person to be involved in any other project on behalf of the Independent Certifier if, in the reasonable opinion of the PA Parties, such involvement would have a material adverse effect on the performance of the Certification Services.
- (b) Any replacement of the individuals listed in Appendix C is subject to the PA Parties' prior written approval.
- (c) The Independent Certifier shall ensure that its personnel providing the Certification Services in respect of the Works shall:
 - (i) possess a current professional designation of not less than membership in Professional Engineers Ontario (PEO), the Ontario Association of Certified Engineering Technicians and Technologists or such similar professional or consulting designation recognized in North America for mechanical, electrical, civil, structural, transportation, geotechnical, environmental, utilities, rail systems, and industrial leads;
 - (ii) possess a current professional designation of not less than Professional Quantity Surveyors (PQS) for the Cost Estimator and any individuals who will prepare and evaluate construction and development information for the cost control and Works measurements for payment;
 - (iii) have demonstrated competence in the planning, design, construction and commissioning of comparable and complex facilities and in having completed or monitored the planning, design, construction and commissioning of facilities and infrastructure comparable to the those included in the Project;
 - (iv) have an understanding of the appropriate standards, guidelines and policies related to planning, design, construction and commissioning of facilities and infrastructure comparable to the those included in the Project;
 - (v) have an understanding of the commissioning process, the reports and any documentation to be provided pursuant to this Independent Certifier Agreement and the Project Agreement, including not only the start-up procedures but the pre-commissioning and post-commissioning activities; and
 - (vi) have the relevant qualifications for their specified area of expertise and membership to the relevant professional bodies which licences them to give their opinions and carry out the relevant works as detailed within this agreement.

- (d) The Independent Certifier shall furnish Contracting Authority with evidence satisfactory to Contracting Authority of any such personnel's compliance with the foregoing requirements within a reasonable time prior to the proposed commencement of the Certification Services in respect of the Works.
- (e) The Independent Certifier shall engage the personnel listed in Appendix C in all day-to-day activities relevant to their area of expertise for the Certification Services.

3.10 Minimize Interference

- (a) The Independent Certifier shall perform the Certification Services in such a way as to minimize any undue interference with the progress of the Works.

4. ROLE OF THE PA PARTIES

4.1 Assistance

- (a) The PA Parties agree to cooperate with and provide reasonable assistance to the Independent Certifier to familiarize the Independent Certifier with all necessary aspects of the Project to enable the Independent Certifier to carry out its obligations under this Independent Certifier Agreement.

4.2 Instructions in Writing

- (a) Unless otherwise provided in this Independent Certifier Agreement or the Project Agreement, all instructions to the Independent Certifier by the PA Parties shall be given in writing and accepted or endorsed by both of the PA Parties.

4.3 Information and Services

- (a) The PA Parties shall make available to the Independent Certifier, as soon as practicable from time to time, all information, documents and particulars necessary for the Independent Certifier to carry out the Certification Services, including such information, documents and particulars required in order for the Independent Certifier to determine whether Interim Completion, Substantial Completion and Final Completion have occurred, and shall provide copies of all such information, documents and particulars to the other party hereto.

4.4 Additional Information

- (a) If any information, documents or particulars are reasonably required to enable the Independent Certifier to perform the Certification Services and have not been provided by the PA Parties, then:
 - (i) the Independent Certifier must give notice in writing to the Project Co Representative or the Contracting Authority Representative, as the case may be, of the details of the information, documents or particulars demonstrating the need and the reasons why they are required; and
 - (ii) Project Co or Contracting Authority, as the case may be, must arrange the provision of the required information, documents or particulars.

4.5 Right to Enter and Inspect

- (a) Upon giving reasonable notice to the Project Co Representative, the Independent Certifier (and any person authorized by it) may enter and inspect the Metrolinx Lands, the New Metrolinx Infrastructure, the New Third Party Infrastructure, the Existing Infrastructure or the Works at any reasonable time in connection with the exercise or proposed exercise of rights under this Independent Certifier Agreement, subject to:
- (i) observance of the reasonable rules of Project Co as to safety and security for the Metrolinx Lands, the New Metrolinx Infrastructure, the New Third Party Infrastructure, the Existing Infrastructure and the Works;
 - (ii) not causing unreasonable delay to the carrying out of the Works by reason of its presence on the Metrolinx Lands, the New Metrolinx Infrastructure, the New Third Party Infrastructure, the Existing Infrastructure or the Works; and
 - (iii) not causing any damage to the Metrolinx Lands, the New Metrolinx Infrastructure, the New Third Party Infrastructure, the Existing Infrastructure or the Works.

4.6 PA Parties not Relieved

- (a) Neither PA Party shall be relieved from performing or observing its obligations, or from any other liabilities, under the Project Agreement as a result of either the appointment of, or any act or omission by, the Independent Certifier.

4.7 PA Parties not Liable

- (a) On no account will a PA Party be liable to another PA Party for any act or omission by the Independent Certifier whether under or purportedly under a provision of the Project Agreement, this Independent Certifier Agreement or otherwise, provided that any such act or omission shall not extinguish, relieve, limit or qualify the nature or extent of any right or remedy of either PA Party against or any obligation or liability of either PA Party to the other PA Party which would have existed regardless of such act or omission.

5. CERTIFICATION QUALITY PLAN

5.1 Certification Quality Plan

- (a) The Independent Certifier must:
- (i) develop and implement a certification quality plan identifying the processes and outcomes of the Certification Services, including but not limited to timelines, deliverables and input required from the PA Parties, that complies with all requirements of the Independent Certifier's quality assurance accreditation, and is otherwise satisfactory to each of the Contracting Authority Representative and the Project Co Representative;

- (ii) within 30 days after the date of this Independent Certifier Agreement, provide a draft of such certification quality plan to each of the Contracting Authority Representative and the Project Co Representative;
- (iii) within 60 days after the date of this Independent Certifier Agreement, provide the final certification quality plan to each of the Contracting Authority Representative and the Project Co Representative;
- (iv) if satisfactory to each of the Contracting Authority Representative and the Project Co Representative, implement such certification quality plan; and
- (v) if not satisfactory to each of the Contracting Authority Representative and the Project Co Representative, within seven days after receiving notice thereof from either PA Party to that effect, revise and resubmit the certification quality plan to each of the Contracting Authority Representative and the Project Co Representative, and implement it if satisfactory to each of the Contracting Authority Representative and the Project Co Representative.

5.2 Certification Quality Plan not to Relieve Independent Certifier

- (a) The Independent Certifier will not be relieved of any responsibilities or obligations in respect of the performance of the Certification Services and will remain solely responsible for them notwithstanding:
 - (i) the obligation of the Independent Certifier to develop and implement a certification quality plan; or
 - (ii) any comment or direction upon, review or acceptance of, approval to proceed with or request to vary any part of the certification quality plan by either the Contracting Authority Representative or the Project Co Representative.

6. SUSPENSION

6.1 Notice

- (a) The Certification Services (or any part) may be suspended at any time by the PA Parties:
 - (i) if the Independent Certifier fails to comply with its obligations under this Independent Certifier Agreement, immediately by the PA Parties giving joint notice in writing to the Independent Certifier; or
 - (ii) in any other case, by the PA Parties giving seven days' joint notice in writing to the Independent Certifier.

6.2 Costs of Suspension

- (a) The Independent Certifier will:

- (i) subject to the Independent Certifier complying with Section 9, be entitled to recover the extra costs incurred by the Independent Certifier by reason of a suspension directed under Section 6.1(a)(ii) valued as a Certification Services Variation under Section 9; and
- (ii) have no entitlement to be paid any costs, expenses, losses or damages arising from a suspension under Section 6.1(a)(i).

6.3 Recommencement

- (a) The Independent Certifier must immediately recommence the carrying out of the Certification Services (or any part) on receipt of a joint written notice from the PA Parties requiring it to do so.

7. INSURANCE AND LIABILITY

7.1 Independent Certifier's Professional Indemnity Insurance

- (a) The Independent Certifier must have in place at all times during the term of this Independent Certifier Agreement:
 - (i) professional liability insurance:
 - (A) in the amount of \$[REDACTED] per claim and \$[REDACTED] in the aggregate, a deductible of not more than \$[REDACTED] per claim and from an insurer and on terms satisfactory to each of the PA Parties; and
 - (B) covering liability which the Independent Certifier might incur as a result of a breach by it of its obligations owed by the Independent Certifier in a professional capacity to the PA Parties, or either of them, under or in connection with this Independent Certifier Agreement or the provision of the Certification Services; and
 - (ii) comprehensive general liability insurance in the amount of \$[REDACTED] per claim and in the aggregate, no deductible for personal injury or bodily injury, a deductible of not more than \$[REDACTED] per occurrence for property damage and from an insurer and on terms satisfactory to each of the PA Parties.
- (b) The Independent Certifier must provide copies of its insurance policies to each of the PA Parties upon execution of this Independent Certifier Agreement, and, at least five Business Days prior to the expiry date of any such insurance policy, the Independent Certifier must provide evidence of the renewal of any such insurance policy satisfactory to the PA Parties, acting reasonably.

7.2 Workers' Compensation Insurance

- (a) The Independent Certifier must, at its own cost and at all times during the term of this Independent Certifier Agreement, insure its liability (including its common law liability) as required under any applicable workers compensation statute or regulation in relation to its employees engaged in the Certification Services.

8. PAYMENT FOR SERVICES

8.1 Payment of Fee

- (a) In consideration of the Independent Certifier performing the Certification Services in accordance with this Independent Certifier Agreement, each PA Party shall pay [REDACTED] of the Fee to the Independent Certifier in accordance with the payment schedule specified in Appendix B.
- (b) The obligation of each PA Party to pay [REDACTED] of the Fee to the Independent Certifier is a several obligation, and neither PA Party shall have any liability in respect of the non-payment by the other PA Party of any fees or costs payable by such other PA Party under this Independent Certifier Agreement.
- (c) The Fee includes all taxes (except for HST), overhead and profit, all labour and materials, insurance costs, travel, hospitality, food and incidental expenses, and all other overhead including any fees or other charges required by law to perform the Certification Services.
- (d) The PA Parties acknowledge and agree that if any approved amount due and payable by the PA Parties to the Independent Certifier in excess of \$[REDACTED] is outstanding for more than 60 days, the Independent Certifier shall not have any obligation to make any certification under the Project Agreement.

9. CERTIFICATION SERVICES VARIATIONS

9.1 Notice of Certification Services Variation

- (a) If the Independent Certifier believes, other than a “Certification Services Variation Order” under Section 9.4(c), that any direction by the PA Parties constitutes or involves a Certification Services Variation it must:
 - (i) within seven days after receiving the direction and before commencing work on the subject matter of the direction, give notice to the PA Parties that it considers the direction constitutes or involves a Certification Services Variation; and
 - (ii) within 21 days after giving the notice under Section 9.1(a)(i), submit a written claim to each of the Contracting Authority Representative and the Project Co Representative which includes detailed particulars of the claim, the amount of the claim and how it was calculated.
- (b) Regardless of whether the Independent Certifier considers that such a direction constitutes or involves a Certification Services Variation, the Independent Certifier must continue to perform the Certification Services in accordance with this Independent Certifier Agreement and all directions, including any direction in respect of which notice has been given under this Section 9.1.

9.2 No Adjustment

- (a) If the Independent Certifier fails to comply with Section 9.1 the Fee will not be adjusted as a result of the relevant direction.

9.3 External Services

- (a) In the event that external personnel or consultants are required for expert opinion with respect to a Certification Services Variation, then, with the prior written approval of the PA Parties, any additional fees relating to such external personnel or consultants will be payable by the PA Parties at the agreed upon amount.

9.4 Certification Services Variation Procedure

- (a) The Contracting Authority Representative and the Project Co Representative may jointly issue a document titled “Certification Services Variation Price Request” to the Independent Certifier which will set out details of a proposed Certification Services Variation which the PA Parties are considering.
- (b) Within seven days after the receipt of a “Certification Services Variation Price Request”, the Independent Certifier must provide each of the Contracting Authority Representative and the Project Co Representative with a written notice in which the Independent Certifier sets out the effect which the proposed Certification Services Variation will have on the Fee.
- (c) Each of the Contracting Authority Representative and the Project Co Representative may then jointly direct the Independent Certifier to carry out a Certification Services Variation by written document titled “Certification Services Variation Order” which will state either that:
 - (i) the Fee is adjusted as set out in the Independent Certifier’s notice; or
 - (ii) the adjustment (if any) to the Fee will be determined under Section 9.5.

9.5 Cost of Certification Services Variation

- (a) Subject to Section 9.2, the Fee will be adjusted for all Certification Services Variations or suspensions under Section 6.1(a)(ii) carried out by the Independent Certifier by:
 - (i) the amount (if any) stated in the “Certification Services Variation Order” in accordance with Section 9.4(c);
 - (ii) if Section 9.5(a)(i) is not applicable, an amount determined pursuant to the fee schedule in Appendix B; or
 - (iii) where such rates or prices are not applicable, a reasonable amount to be agreed between the PA Parties and the Independent Certifier or, failing agreement, determined by the Contracting Authority Representative and the Project Co Representative jointly.
- (b) Any reductions in the Fee shall be calculated on the same basis as any increases.

10. TERM AND TERMINATION

10.1 Term

- (a) Subject to earlier termination, this Independent Certifier Agreement will commence on the date of the Project Agreement and continue in full force until:
 - (i) the Final Completion Date; or
 - (ii) such other date as may be mutually agreed between the PA Parties and the Independent Certifier.

10.2 Notice of Breach

- (a) If the Independent Certifier commits a breach of this Independent Certifier Agreement, the PA Parties may give written notice to the Independent Certifier:
 - (i) specifying the breach; and
 - (ii) directing its rectification in the period specified in the notice being a period not less than seven days from the date of service of the notice.

10.3 Termination for Breach

- (a) If the Independent Certifier fails to rectify the breach within the period specified in the notice issued under Section 10.2, the PA Parties may, without prejudice to any other rights of the PA Parties or either of them, immediately terminate this Independent Certifier Agreement.

10.4 Termination for Financial Difficulty or Change in Control

- (a) The PA Parties may, without prejudice to any other rights which the PA Parties or either of them may have, terminate this Independent Certifier Agreement immediately if:
 - (i) events have occurred or circumstances exist which, in the opinion of the PA Parties, may result in or have resulted in an insolvency or a Change in Control of the Independent Certifier; or
 - (ii) the Independent Certifier has communications with its creditors with a view to entering into, or enters into, any form of compromise, arrangement or moratorium of any debts whether formal or informal, with its creditors.

10.5 Termination for Convenience

- (a) Notwithstanding anything to the contrary in this Independent Certifier Agreement, the PA Parties may, at any time, jointly terminate this Independent Certifier Agreement upon 30 days written notice to the Independent Certifier. The PA Parties and the Independent Certifier agree that, notwithstanding the 30 days' notice of termination, the Independent Certifier shall continue on a day-to-day basis thereafter until a new Independent Certifier is appointed.

10.6 Independent Certifier's Rights upon Termination for Convenience

- (a) Upon a termination under Section 10.5, the Independent Certifier will:
- (i) be entitled to be reimbursed by the PA Parties for the value of the Certification Services performed by it to the date of termination; and
 - (ii) not be entitled to any damages or other compensation in respect of the termination and (without limitation) any amount in respect of:
 - (A) the lost opportunity to earn a profit in respect of the Certification Services not performed at the date of termination; and
 - (B) any lost opportunity to recover overheads from the turnover which would have been generated under this Independent Certifier Agreement but for it being terminated.

10.7 Procedure upon Termination

- (a) Upon completion of the Independent Certifier's engagement under this Independent Certifier Agreement or earlier termination of this Independent Certifier Agreement (whether under Section 10.3, 10.4 or 10.5 or otherwise), the Independent Certifier must:
- (i) cooperate with the PA Parties with respect to the transition of the Certification Services to a replacement certifier;
 - (ii) deliver to the PA Parties all Contract Material and all other information concerning the Project held or prepared by the Independent Certifier during the execution of work under this Independent Certifier Agreement; and
 - (iii) as and when required by the PA Parties, meet with them and such other persons nominated by them with a view to providing them with sufficient information to enable the PA Parties to execute the Project or the persons nominated to provide the Certification Services.

10.8 Effect of Termination

- (a) Except as otherwise expressly provided in this Independent Certifier Agreement, termination of this Independent Certifier Agreement shall be without prejudice to any accrued rights and obligations under this Independent Certifier Agreement as at the date of termination (including the right of the PA Parties to recover damages from the Independent Certifier).

10.9 Survival

- (a) Termination of this Independent Certifier Agreement shall not affect the continuing rights and obligations of the PA Parties and the Independent Certifier under Sections 7, 8, 10.6, 10.7, 10.8, 11, 12.7, 12.8, and this Section 10.9 or under any other provision which is expressed to survive termination or which is required to give effect to such termination or the consequences of such termination.

11. INDEMNITY

11.1 PA Parties to Save Independent Certifier Harmless

- (a) The PA Parties hereby indemnify and save the Independent Certifier completely harmless from any actions, causes of action, suits, debts, costs, damages, expenses, claims and demands whatsoever, at law or in equity, arising directly or indirectly in whole or in part out of any action taken by the Independent Certifier within the scope of its duties or authority hereunder.
- (b) The indemnity provided under this Section 11.1 shall not extend:
 - (i) to any breach of this Independent Certifier Agreement, or any part or parts hereof, by the Independent Certifier, its employees, servants, agents or persons for whom it is in law responsible, or any negligent or unlawful act or omission or willful misconduct of the Independent Certifier, its employees, servants or persons for whom it is in law responsible (in respect of which the Independent Certifier shall indemnify the PA Parties, as referred to in Section 11.2);
 - (ii) to any action taken by the Independent Certifier outside the scope of authority set forth in this Independent Certifier Agreement, or any part or parts hereof; or
 - (iii) to any debt, cost, expense, claim or demand for which insurance proceeds are recoverable by the Independent Certifier.
- (c) This indemnity shall survive the termination of this Independent Certifier Agreement.

11.2 Independent Certifier to Save PA Parties Harmless

- (a) The Independent Certifier hereby indemnifies and saves the PA Parties, and their affiliated entities, subsidiaries and their respective directors, officers, employees, agents, permitted successors and assigns, completely harmless from any actions, causes of action, suits, debts, costs, damages, expenses, claims and demands whatsoever, at law or in equity, arising directly or indirectly in whole or in part out of any breach of this Independent Certifier Agreement, or any part or parts hereof, by the Independent Certifier, its employees, servants, agents or persons for whom it is in law responsible, or any negligent or unlawful act or omission or willful misconduct of the Independent Certifier, its employees, servants or persons for whom it is in law responsible.
- (b) The indemnity provided under this Section 11.2 to a PA Party shall not extend:
 - (i) to any negligent or unlawful act or omission or willful misconduct of such PA Party, its employees, servants or persons for whom it is in law responsible (in respect of which such PA Parties shall indemnify the Independent Certifier, as referred to in Section 11.1); or
 - (ii) to any debt, cost, expense, claim or demand for which insurance proceeds are recoverable by such PA Party.
- (c) This indemnity shall survive the termination of this Independent Certifier Agreement.

11.3 Conduct of Claims

- (a) Claims made by a third person against a party having, or claiming to have, the benefit of an indemnity pursuant to this Independent Certifier Agreement shall be conducted in accordance with the conduct of claims procedure described in Appendix D – Conduct of Claims to this Independent Certifier Agreement.

12. GENERAL

12.1 Entire Agreement

- (a) Except where provided otherwise in this Independent Certifier Agreement, this Independent Certifier Agreement constitutes the entire agreement between the parties in connection with its subject matter and supersedes all prior representations, communications, negotiations and understandings, whether oral, written, express or implied, concerning the subject matter of this Independent Certifier Agreement.

12.2 Negation of Employment

- (a) The Independent Certifier, its officers, directors, members, employees, servants and agents and any other persons engaged by the Independent Certifier in the performance of the Certification Services will not by virtue of this Independent Certifier Agreement or the performance of the Certification Services become in the service or employment of the PA Parties for any purpose.
- (b) The Independent Certifier will be responsible for all matters requisite as employer or otherwise in relation to such officers, directors, members, employees, servants and agents and other persons who are engaged by the Independent Certifier.

12.3 Waiver

- (a) No waiver made or given by a party under or in connection with this Independent Certifier Agreement shall be binding or effective unless the waiver is in writing, signed by an authorized representative of the party giving such waiver, and delivered by such party to the other parties. No waiver made with respect to any right, power or remedy in one instance will be deemed to be a waiver with respect to any other instance involving the exercise of such right, power, or remedy or with respect to any other right, power, or remedy.
- (b) Failure by any party to exercise any of its rights, powers or remedies hereunder or its delay to do so shall not constitute a waiver of those rights, powers or remedies. The single or partial exercise of a right, power or remedy shall not prevent its subsequent exercise or the exercise of any other right, power or remedy.

12.4 Notices

- (a) All notices, requests, demands, instructions, certificates, consents and other communications required or permitted under this Independent Certifier Agreement shall be in writing (whether or not “written notice” or “notice in writing” is specifically required by the applicable provision of

this Independent Certifier Agreement) and served by sending the same by registered mail, facsimile or by hand (in each case, with a copy by electronic submission), as follows:

If to Contracting Authority: **[REDACTED]**
Fax No.: **[REDACTED]**
Attn.: **[REDACTED]**
with a copy to:
[REDACTED]
Fax No.: **[REDACTED]**
Attn.: **[REDACTED]**

If to Project Co: **[REDACTED]**
Fax No.: **[REDACTED]**
Email: **[REDACTED]**
Attn.: **[REDACTED]**
with a copy to:
Email: **[REDACTED]**
Attn.: **[REDACTED]**

If to Independent Certifier: **[REDACTED]**
Email: **[REDACTED]**
Attn.: **[REDACTED]**

- (b) Where any notice is provided or submitted to a party via facsimile, an original of the notice sent via facsimile shall promptly be sent by regular mail or registered mail. For greater certainty, a notice given via facsimile shall not be invalid by reason only of a party's failure to comply with this Section 12.4(b).
- (c) Any party to this Independent Certifier Agreement may, from time to time, change any of its contact information set forth in Section 12.4(a) by prior notice to the other parties, and such change shall be effective on the Business Day that next follows the recipient party's receipt of such notice unless a later effective date is given in such notice.
- (d) Subject to Sections 12.4(e), 12.4(f) and 12.4(g):
 - (i) a notice given by registered mail shall be deemed to have been received on the third Business Day after mailing;
 - (ii) a notice given by hand delivery shall be deemed to have been received on the day it is delivered; and
 - (iii) a notice given by facsimile shall be deemed to have been received on the day it is transmitted by facsimile.

- (e) If the party giving the notice knows or ought reasonably to know of difficulties with the postal system which might affect negatively the delivery of mail, any such notice shall not be mailed but shall be made or given by personal delivery or by facsimile transmission in accordance with this Section 12.4.
- (f) If any notice delivered by hand or transmitted by facsimile is so delivered or transmitted, as the case may be, either on a day that is not a Business Day or on a Business Day after 4:00 p.m. (recipient's local time), then such notice shall be deemed to have been received by such recipient on the next Business Day.
- (g) A notice given by facsimile shall be deemed to have been received by the recipient on the day it is transmitted only if a facsimile transmission report (maintained by the sender) indicates that the transmission of such notice was successful.

12.5 Transfer and Assignment

- (a) The Independent Certifier:
 - (i) must not assign, transfer, mortgage, charge or encumber any right or obligation under this Independent Certifier Agreement without the prior written consent of the PA Parties, which each PA Party may give or withhold in its absolute discretion; and
 - (ii) agrees that any assignment, transfer, mortgage, charge or encumbrance will not operate to release or discharge the Independent Certifier from any obligation or liability under this Independent Certifier Agreement.
- (b) For the purposes of this Section 12.5, an assignment will be deemed to have occurred where there is a Change in Control of the Independent Certifier after the date of this Independent Certifier Agreement.
- (c) Each of the PA Parties may assign, transfer, mortgage, charge or encumber any right or obligation under this Independent Certifier Agreement in accordance with the terms of the Project Agreement.

12.6 Governing Laws and Jurisdictions

- (a) This Independent Certifier Agreement shall be governed by and construed in accordance with the laws of Ontario and the laws of Canada applicable therein and shall be treated in all respects as an Ontario contract, without regard to conflict of laws principles.
- (b) The PA Parties and the Independent Certifier agree that the courts of the Province of Ontario and all courts competent to hear appeals therefrom shall have exclusive jurisdiction to hear and settle any action, suit, proceeding or dispute in connection with this Independent Certifier Agreement and hereby irrevocably attorn to the exclusive jurisdiction of such courts.
- (c) Nothing in this Independent Certifier Agreement affects the rights, protections and immunities of the Crown under the *Proceedings Against the Crown Act* (Ontario).

12.7 Contracting Authority Designate

- (a) At any time and from time to time, the Crown may designate any ministry, branch, agency, division, department or office of the Government of Ontario to carry out administrative responsibility for the rights and obligations of Contracting Authority under this Independent Certifier Agreement and Project Co and the Independent Certifier may deal exclusively with the designated person in respect of all such matters and is entitled to rely on the actions, directions, requests, notices, consents, approvals, waivers, comments relating to the review of documentation and other administrative matters and decisions determined by such designated person from time to time, until the Crown has notified Project Co and the Independent Certifier in writing that such designated person is no longer the person designated by the Crown hereunder and such notice shall have effect on the later of the date of delivery of such notice and the date specified in the written notice. The Crown shall advise Project Co and the Independent Certifier in writing of any designation hereunder. The rights and obligations of the parties to this Independent Certifier Agreement shall be in no way affected by reason of any such designation. Project Co and the Independent Certifier acknowledge the right of the Crown to delegate administrative responsibilities hereunder as set forth in this Section 12.7.

12.8 Confidentiality

- (a) The Independent Certifier must ensure that:
- (i) neither it nor any of its officers, directors, members, employees, servants and agents disclose, or otherwise make public, any Contract Material or any other information or material acquired in connection with or during the performance of the Certification Services without prior written approval of the PA Parties; and
 - (ii) no Contract Material is used, copied, supplied or reproduced for any purpose other than for the performance of the Certification Services under this Independent Certifier Agreement.
- (b) The PA Parties may at any time require the Independent Certifier to give and to arrange for its officers, directors, members, employees, servants and agents engaged in the performance of the Certification Services to give written undertakings, in the form of confidentiality agreements on terms required by the PA Parties, relating to the non disclosure of confidential information, in which case the Independent Certifier must promptly arrange for such agreements to be made.

12.9 Contract Material

- (a) The PA Parties and the Independent Certifier agree that the Independent Certifier does not and will not have any rights, including any Intellectual Property, in any Contract Material provided to the Independent Certifier or created or required to be created by either PA Party.
- (b) As between the PA Parties and the Independent Certifier, all title and ownership, including all Intellectual Property, in and to the Contract Material created or required to be created by the Independent Certifier as part of, or for the purposes of performing the Certification Services, is hereby assigned jointly to the PA Parties on creation, or where such title, ownership and Intellectual Property cannot be assigned before creation of the Contract Material, it will be assigned to the PA Parties on creation. In addition, to the extent that copyright may subsist in such Contract Material so created by the Independent Certifier, the Independent Certifier hereby waives all past, present

and future moral rights therein and the Independent Certifier shall ensure that any agent or employee of Independent Certifier shall have waived all such moral rights. The PA Parties acknowledge and agree that as between the PA Parties, title, ownership and other rights to the foregoing shall be governed by the Project Agreement.

- (c) The Independent Certifier will do all such things and execute all such documents as reasonably requested by either of the PA Parties in order to confirm or perfect the assignment of Intellectual Property in the Contract Material referred to in Section 12.9(b).

12.10 Amendment

- (a) This Independent Certifier Agreement may not be varied, amended or supplemented except by an agreement in writing signed by duly authorized representatives of the PA Parties and the Independent Certifier and stating on its face that it is intended to be an amendment, restatement or other modification, as the case may be, to this Independent Certifier Agreement.

12.11 Severability

- (a) Each provision of this Independent Certifier Agreement shall be valid and enforceable to the fullest extent permitted by law. If the courts of a competent jurisdiction shall declare any provision of this Independent Certifier Agreement invalid, unenforceable or illegal, such provision may be severed and such invalidity, unenforceability or illegality shall not prejudice or affect the validity, enforceability and legality of the remaining provisions of this Independent Certifier Agreement. If any such provision of this Independent Certifier Agreement is invalid, unenforceable or illegal, the parties shall, acting in good faith, promptly negotiate new provisions to eliminate such invalidity, unenforceability or illegality and to restore this Independent Certifier Agreement as near as possible to its original intent and effect.

12.12 Enurement

- (a) This Independent Certifier Agreement shall enure to the benefit of, and be binding on, each of the parties and their respective successors and permitted transferees and assigns.

12.13 Counterparts

- (a) This Independent Certifier Agreement may be executed in one or more counterparts. Any single counterpart or a set of counterparts executed, in either case, by all the parties shall constitute a full, original and binding agreement for all purposes. Counterparts may be executed either in original or faxed form provided that any party providing its signature in faxed form shall promptly forward to such party an original signed copy of this Independent Certifier Agreement which was so faxed.

12.14 Joint and Several

- (a) IO, as Crown agent and Metrolinx, as Crown agency, shall be liable, on a joint and several basis, for all of the obligations of Contracting Authority under this Independent Certifier Agreement and for each covenant of the other under this Independent Certifier Agreement.

12.15 Copyright Notice

- (a) The parties acknowledge that the Queen’s Printer for Ontario is the exclusive owner of the copyright in the Project Agreement and this Independent Certifier Agreement.

[SIGNATURE PAGES IMMEDIATELY FOLLOW]

IN WITNESS WHEREOF the parties have executed this Independent Certifier Agreement as of the date first above written.

ONTARIO INFRASTRUCTURE AND LANDS CORPORATION, a Crown agent, continued under the *Ontario Infrastructure and Lands Corporation Act, 2011*

Per: _____
Name: [REDACTED]
Title: [REDACTED]

I have authority to bind the corporation.

METROLINX

Per: _____
Name:
Title:

Per: _____
Name:
Title:

GCRS DAVENPORT GENERAL PARTNERSHIP,
by its partners:

GCP DAVENPORT INC.

Per: _____

Name: **[REDACTED]**

Title: **[REDACTED]**

I have authority to bind the corporation.

GRACORP DAVENPORT INC.

Per: _____

Name: **[REDACTED]**

Title: **[REDACTED]**

I have authority to bind the corporation.

[REDACTED]

Per: _____
Name:
Title:

Per: _____
Name:
Title:

**APPENDIX A
CERTIFICATION SERVICES**

Without limiting the other provisions of this Independent Certifier Agreement and the Project Agreement, the Independent Certifier shall:

- (a) Develop and implement a certification quality plan identifying the processes and outcomes of the Certification Services including timelines, deliverables and a description of the input required from the PA Parties to carry out the Certification Services.
- (b) Receive, monitor and review all relevant Project documentation including drawings, plans, reports, certifications, schedules, letters, notices and test results as necessary for the Independent Certifier to be informed as to the progress of the Works (including, for certainty, the reports described in Sections 12, 13 and 14 of Schedule 12 – Works Schedule Requirements), and to provide an opinion in the event of a Dispute related to the development of the design. The Independent Certifier personnel listed in Appendix C shall be up to date with all Project documentation relevant to their area of expertise.
- (c) Review information relating to Construction Period Quality Failures, Delay Events and the events described in Section 32.2 of the Project Agreement, and Compensation Events.
- (d) Review information relating to Variation Enquiries, Project Co Variation Notices, Variations, Estimates, claims for extension of time and compensation and consultation with the relevant party.
- (e) Issue a certificate for payment of (i) the Legislative Holdback pursuant to Section 4.5(c) of the Project Agreement, and (ii) the Finishing Holdback pursuant to Section 4.6(c) of the Project Agreement.
- (f) In accordance with Sections 14.1(b) and 14.6(b) of the Project Agreement, attend all meetings and deliberations of and participate, as necessary, in the activities of the Works Committee with respect to Proceeding at Risk Matters.
- (g) Provide its written opinion and supporting analysis as to whether Project Co is Proceeding at Risk pursuant to Section 14.6(f) of the Project Agreement.
- (h) Identify any risks that may impede the issuance of the Interim Completion Certificate, the Substantial Completion Certificate or the Final Completion Certificate and inform the PA Parties thereof.
- (i) In accordance with Section 11.15 of the Project Agreement, perform all responsibilities of the Independent Certifier in connection with Construction Defects.
- (j) In accordance with Section 24.4 of the Project Agreement, perform all responsibilities of the Independent Certifier in connection with the Interim Completion Certification.

- (k) Review the draft Works Submittals related to commissioning, the draft Interim Commissioning Program, the draft Final Commissioning Program and the detailed test, test methodology and expected test results proposed by Project Co, including any review comments from Contracting Authority, and provide a report on the effectiveness of the Final Commissioning Program, to identify any errors or omissions and to report any risks.
- (l) Monitor, and report on, the implementation of the commissioning plan (as indicatively described in Schedule 14 – Outline Commissioning Program and Handover) and other tests, including re-tests, to be performed as set out in the Outline Commissioning Program or as otherwise required for Project Co to achieve Interim Completion, Substantial Completion and Final Completion.
- (m) Witness the implementation of a sample of the Commissioning Tests and a sample of the other testing and commissioning procedures at random times, locations and frequencies, in each case to the extent required for the Independent Certifier to verify that the requirements of Interim Completion, Substantial Completion and Final Completion have been met.
- (n) In accordance with Sections 25.15(j)(ii) and 25.15(j)(iii) of the Project Agreement, make a determination with respect to unresolved Project Co Commissioning or Handover issues.
- (o) Prior to any certification, consider the views and comments of Project Co and Contracting Authority (including its consultants and advisors), as applicable, in relation to the satisfaction of the conditions for certification.
- (p) Employing the relevant personnel, conduct regular inspections of the Works and attend Site progress meetings at a minimum on a monthly basis or more regularly as deemed necessary for the Independent Certifier to be satisfied that the Works are proceeding in accordance with the requirements of the Project Agreement. Report on the observations, findings and potential risks to certification as a result of the regular inspections as part of the Monthly Report.
- (q) Upon receipt of notice from Project Co requesting the issuance of an Interim Completion Certificate, Substantial Completion Certificate or Final Completion Certificate, as applicable, (i) with respect to the Interim Completion Certificate, perform the activities set out in Section 24.4(c) of the Project Agreement, (ii) with respect to the Substantial Completion Certificate, perform the activities set out in Section 25.4(c) of the Project Agreement, and (iii) with respect to each of the Interim Completion Certificate, the Substantial Completion Certificate and the Final Completion Certificate, consider such request and, within the time period set out in the Project Agreement and in accordance with the Project Agreement, either:
 - (A) issue the applicable certificate; or
 - (B) issue a report detailing the matters that the Independent Certifier considers are required to be performed prior to issuing the applicable certificate.
- (r) Upon notice from Project Co that the matters required to be performed prior to issuing the applicable certificate have been completed, re-inspect the Works or re-consider the matters specified to be performed, and repeat the procedures in Section (r) of this Appendix A until the issuance of the applicable certificate.

- (s) In accordance with Sections 24 and 25 of the Project Agreement, perform all responsibilities of the Independent Certifier in connection with the Interim Minor Deficiencies and the Minor Deficiencies regimes, including, for clarity, ensuring that,
 - (i) for each Interim Minor Deficiency, the Independent Certifier shall specify a time for completion and rectification that is no later than six months following the Interim Completion Date;
 - (ii) for each Minor Deficiency (other than Minor Deficiencies that are seasonal in nature and cannot be completed prior to the Final Completion Date), the Independent Certifier shall specify a time for completion and rectification that is no later than six months following the Substantial Completion Date; and
 - (iii) for each Minor Deficiency that is seasonal in nature and cannot be completed prior to the Final Completion Date, the Independent Certifier shall specify a time for completion and rectification that is no later than six months following the Final Completion Date.
- (t) Review and monitor the installation of all equipment, fixtures, information technology, communication equipment, telephone equipment and anything similar to the foregoing (collectively, the “**Installed Equipment**”) into the New Metrolinx Infrastructure or the New Third Party Infrastructure by Contracting Authority or any agent or contractor of Contracting Authority either before or after Interim Completion and Substantial Completion and provide a report to Contracting Authority and Project Co identifying any damage to the New Metrolinx Infrastructure or the New Third Party Infrastructure which has been caused as a result of the installation of such Installed Equipment into the New Metrolinx Infrastructure or the New Third Party Infrastructure by Contracting Authority, their contractors and/or agents.
- (u) Provide any determinations contemplated in the Project Agreement, which determinations may be subject to final resolution between the PA Parties pursuant to Schedule 27 – Dispute Resolution Procedure to the Project Agreement.
- (v) Participate in and give the PA Parties and their counsel reasonable cooperation, access and assistance (including providing or making available documents, information and witnesses for attendance at hearings and other proceedings) in connection with any proceedings between the PA Parties that relate to the Certification Services.
- (w) Provide periodic reports to the PA Parties, copying IO, as follows:
 - (i) a progress report within 15 Business Days after each month’s end or as otherwise agreed by the PA Parties (“**Monthly Report**”) which includes the following:
 - (A) summary of activities carried out by the Independent Certifier, making specific reference to each of the Independent Certifier’s obligations;
 - (B) the status of any risks that may impede the issuance of the Interim Completion Certificate, Substantial Completion Certificate or the Final Completion Certificate;

- (C) an opinion on Non-Conformances, if any, and whether or not such Non-Conformances are of the extent and nature that would normally be expected on projects of this kind;
 - (D) progress on all aspects of the Works; and
 - (E) commencing no less than 180 days prior to the Scheduled Interim Completion Date and Scheduled Substantial Completion Date, the Monthly Report shall contain specific reference to and listing of the work that needs to be done before an Interim Completion Certificate, a Substantial Completion Certificate or a Final Completion Certificate can be issued; and
- (ii) accompanying the Monthly Reports delivered for the months of May, August, November and February, a quarterly report (the “**Quarterly Report**”) for the quarters ending March 31st, June 30th, September 30th and December 31st respectively, in substantially the form as that in Appendix E and that contains the following information certified in accordance with the standard of care set out in Section 3.3 of the Independent Certifier Agreement:
- (A) the extent (expressed as a percentage) of completion of the Works as of the last day of the applicable quarter;
 - (B) the value of the Works completed as of the last day of the applicable quarter;
 - (C) the forecasted extent (expressed as a percentage) of completion of the Works as of the last day of the applicable quarter and for the next four quarters; and
 - (D) the forecasted value of the Works anticipated to be completed as of the last day of the applicable quarter and for the next four quarters.
- (x) Participate in meetings with the PA Parties as required for the Independent Certifier to perform Certification Services.
- (y) Acknowledge receipt of all Design Certificates and Construction Certificates delivered by Project Co in accordance with Schedule 10 – Review Procedure to the Project Agreement.
- (z) Provide any determinations contemplated in Schedule 21 – Liquidated Damages and Construction Enforcement Regime.
- (aa) Provide advice on other matters that may arise that both PA Parties may jointly require.
- (bb) Prepare the Interim Completion Deliverables List pursuant to Section 24.8(e) of the Project Agreement and, if applicable, amend such list pursuant to Section 24.8(e) of the Project Agreement.
- (cc) Prepare the Substantial Completion Deliverables List pursuant to Section 25.8(e) of the Project Agreement and, if applicable, amend such list pursuant to Section 25.8(e) of the Project Agreement.
- (dd) In accordance with Section 25A of the Project Agreement, perform all responsibilities of the Independent Certifier in connection with the Milestone Payments.

**APPENDIX B
INDEPENDENT CERTIFIER FEE**

[REDACTED]

**APPENDIX C
INDEPENDENT CERTIFIER PERSONNEL**

The following personnel shall be involved in the performance of the Certification Services:

Name	Position
[REDACTED]	[REDACTED]
[REDACTED]	[REDACTED]
[REDACTED]	[REDACTED]
[REDACTED]	[REDACTED]
[REDACTED]	[REDACTED]
[REDACTED]	[REDACTED]
[REDACTED]	[REDACTED]
[REDACTED]	[REDACTED]
[REDACTED]	[REDACTED]
[REDACTED]	[REDACTED]
[REDACTED]	[REDACTED]
[REDACTED]	[REDACTED]

**APPENDIX D
CONDUCT OF CLAIMS**

This Appendix D shall apply to the conduct of claims, made by a third person against a party having, or claiming to have, the benefit of an indemnity pursuant to this Independent Certifier Agreement. The party having, or claiming to have, the benefit of the indemnity is referred to as the “**Beneficiary**” and a party giving the indemnity is referred to as an “**Indemnifier**”.

- (1) If the Beneficiary receives any notice, demand, letter or other document concerning any claim for which it appears that the Beneficiary is, or may become entitled to, indemnification under Section 11 of the Independent Certifier Agreement, the Beneficiary shall give written notice to each Indemnifier potentially obligated in respect thereof, as soon as reasonably practicable and in any event within 10 Business Days following receipt of the same. Such notice shall specify with reasonable particularity, to the extent that information is available, the factual basis for the claim and the amount of the claim.
- (2) Subject to Sections (3), (4) and (5) of this Appendix D, on the giving of such notice by the Beneficiary, where it appears that the Beneficiary is or may be entitled to indemnification from an Indemnifier in respect of all, but not part only, of the liability arising out of the claim, such Indemnifier shall (subject to providing the Beneficiary with a secured indemnity to the Beneficiary’s reasonable satisfaction against all costs and expenses that the Beneficiary may incur by reason of such action) be entitled to dispute the claim in the name of the Beneficiary at the Indemnifier’s own expense and take conduct of any defence, dispute, compromise, or appeal of the claim and of any incidental negotiations. The Beneficiary shall give such Indemnifier all reasonable cooperation, access and assistance for the purposes of considering and resisting such claim. The Beneficiary shall have the right to employ separate counsel in respect of such claim and the reasonable fees and expenses of such counsel shall be to the account of the Indemnifier only where representation of both the Indemnifier and the Beneficiary by common counsel would be inappropriate due to any actual or potential conflicting interests between the Indemnifier and the Beneficiary. If and to the extent that both Contracting Authority and Project Co are given notice in respect of the same claim, they shall cooperate in the conduct of the claim and give each other such reasonable access and assistance as may be necessary or desirable for purposes of considering, resisting and defending such claim.
- (3) With respect to any claim conducted by an Indemnifier:
 - (i) the Indemnifier shall keep the Beneficiary fully informed and consult with it about material elements of the conduct of the claim;
 - (ii) the Indemnifier shall not bring the name or reputation of the Beneficiary into disrepute;
 - (iii) the Indemnifier shall not pay, compromise or settle such claims without the prior consent of the Beneficiary, such consent not to be unreasonably withheld or delayed;
 - (iv) the Indemnifier shall not admit liability or fault to any third party without the prior consent of the Beneficiary, such consent not to be unreasonably withheld or delayed; and

- (v) the Indemnifier shall use commercially reasonable efforts to have the Beneficiary named as a beneficiary under any release given by the persons bringing the claim to which Section (3) of this Appendix D relates.
- (4) The Beneficiary shall be free to pay or settle any such claim on such terms as it thinks fit and without prejudice to its rights and remedies under this Independent Certifier Agreement if:
 - (i) none of the Indemnifiers is entitled to take conduct of the claim in accordance with Section (2) of this Appendix D;
 - (ii) none of the Indemnifiers notifies the Beneficiary of its intention to take conduct of the relevant claim as soon as reasonably practicable and in any event within 10 Business Days following the notice from the Beneficiary under Section (1) of this Appendix D or each of the Indemnifiers notifies the Beneficiary that it does not intend to take conduct of the claim; or
 - (iii) none of the Indemnifiers complies in any material respect with Section (3) of this Appendix D.
- (5) The Beneficiary shall be free at any time to give notice to the applicable Indemnifier that the Beneficiary is retaining or taking over, as the case may be, the conduct of any defence, dispute, compromise or appeal of any claim, or of any incidental negotiations, to which Section (2) of this Appendix D applies. For greater certainty, the Independent Certifier acknowledges and agrees that where Contracting Authority is the Beneficiary, Contracting Authority may retain or take over such conduct in any matter involving Personal Information or any matter involving public policy. On receipt of such notice the applicable Indemnifier shall promptly take all steps necessary to transfer the conduct of such claim to the Beneficiary, and shall provide to the Beneficiary all relevant documentation and all reasonable cooperation, access and assistance for the purposes of considering and resisting such claim. If the Beneficiary gives any notice pursuant to Section (5) of this Appendix D, then the applicable Indemnifier shall be released from any liabilities arising under the applicable indemnity hereunder in respect of the applicable claim.
- (6) If an Indemnifier pays to the Beneficiary an amount in respect of an indemnity and the Beneficiary subsequently recovers, whether by payment, discount, credit, saving, relief or other benefit or otherwise, a sum or anything else of value (the “**Recovery Amount**”) which is directly referable to the fact, matter, event or circumstances giving rise to the claim under the indemnity, the Beneficiary shall forthwith repay to that Indemnifier whichever is the lesser of:
 - (i) an amount equal to the Recovery Amount less any out-of-pocket costs and expenses properly incurred by the Beneficiary in recovering the same; and
 - (ii) the amount paid to the Beneficiary by such Indemnifier in respect of the claim under the relevant indemnity,

provided that there shall be no obligation on the Beneficiary to pursue any Recovery Amount and that the Indemnifier shall be repaid only to the extent that the Recovery Amount, aggregated with any sum recovered from the Indemnifier, exceeds the loss sustained by the Beneficiary except,

however, that if the Beneficiary elects not to pursue a Recovery Amount, the Indemnifier shall be entitled to require an assignment to it of the right to do so.

- (7) Any person taking any of the steps contemplated by this Appendix D shall comply with the requirements of any insurer who may have an obligation to provide an indemnity in respect of any liability arising under this Independent Certifier Agreement.

APPENDIX E
FORM OF QUARTERLY REPORT

[ON THE INDEPENDENT CERTIFIER'S LETTERHEAD]

[date]

Metrolinx
[REDACTED]

Attn.: [REDACTED]

and to:

GCRS Davenport General Partnership
[REDACTED]

Attn.: [REDACTED]
Fax No.: [REDACTED]
Email: [REDACTED]

with a copy to:

Attn.: [REDACTED]
Email: [REDACTED]

with a copy to:

Ontario Infrastructure and Lands Corporation
[REDACTED]

Attn.: [REDACTED]
Fax No.: [REDACTED]

Dear ■ and ■:

This report, for the quarter ending ■, is delivered to you pursuant to (v)(ii) of the Independent Certifier Agreement between Ontario Infrastructure and Lands Corporation, Metrolinx and Project Co, and is dated July 25, 2019 (the “**IC Agreement**”). Terms not otherwise defined herein have the meaning ascribed to them in the IC Agreement.

All values stated herein are based on the Cost of the Works and are exclusive of HST. This report has taken into account the following information: **[insert particulars of sources of information (e.g., works reports, Site visits) used to prepare the report]**.

Based on our analysis of the foregoing, we confirm the following to the best of our professional knowledge and judgment:

Confidential

Page 35

Queen's Printer for Ontario © Copyright 2019 - This document must not be copied or reproduced in any manner without the written permission of Infrastructure Ontario.

- As of the date hereof, the value of the Works is \$■ and the Works are ■% complete.
- At the end of this quarter, the estimated value of the Works will be \$■ and the Works are forecasted to be % complete.

We estimate that the value of the Works and the extent of their completion will be as follows for the next four quarters (not including the present quarter):

	[quarter end date]	[quarter end date]	[quarter end date]	[quarter end date]
\$				
%				

We have prepared this report for the specific use of Ontario Infrastructure and Lands Corporation, Metrolinx and GCRS Davenport General Partnership. This letter is not intended for general circulation, publication or reproduction for any other person or purpose without express written permission to each specific instance.

Yours truly,

[Name and Signature of Independent
Certifier]

**SCHEDULE 7A
STANDBY LETTER OF CREDIT**

[REDACTED]

**SCHEDULE 7B
WARRANTY LETTER OF CREDIT**

[REDACTED]

**SCHEDULE 8
PROJECT CO PARTIES**

[REDACTED]

**SCHEDULE 9
KEY INDIVIDUALS
[REDACTED]**

SCHEDULE 10

REVIEW PROCEDURE

1. WORKS SUBMITTALS

- 1.1 The provisions of this Schedule 10 shall apply to the Design Development Submittal, the Construction Document Submittals, the Design Data and any and all items, documents and anything else required or specified by the Project Agreement, including all Works Submittals listed in Appendices A, B, C, D and E to this Schedule 10, in respect of the Works to be submitted to, reviewed or otherwise processed by Contracting Authority in accordance with the Review Procedure prior to Interim Completion and Substantial Completion, as applicable, or after Interim Completion and Substantial Completion, as applicable, in respect of the completion of Interim Completion Minor Deficiencies and Minor Deficiencies, as applicable, and in respect of the rectification of any Works, the New Metrolinx Infrastructure, and the New Third Party Infrastructure or any part thereof as required pursuant to Section 10.3(c) of the Project Agreement, including any and all subsequent revisions, amendments and changes thereto (individually, “**Works Submittal**” or collectively, “**Works Submittals**” as applicable in this Schedule 10).
- 1.2 For clarity, the provisions of this Schedule 10, including any deadlines for submission or review set out herein, shall not apply to any processing or review of any Permit, Licence, Approval, or Agreement.
- 1.3 Subject to Section 1.2, if the Municipality fails to meet the timelines set out in this Schedule 10 with respect to its review of any Works Submittals, such failure shall be deemed to be a failure by Contracting Authority to comply with the timelines set out in this Schedule 10.
- 1.4 Subject to Section 1.2, if CP fails to meet the timelines set out in this Schedule 10 with respect to its review of any Works Submittals, such failure shall be deemed to be a failure by Contracting Authority to comply with the timelines set out in this Schedule 10.

2. SCHEDULE FOR WORKS SUBMITTALS

- 2.1 Intentionally Deleted.
- 2.2 The Baseline Works Schedule shall allow:
- (a) for Works Submittals, excluding those Works Submittals set out in Appendix B, Appendix C, and Appendix E to this Schedule 10, a period of 15 Business Days (or such longer period as may be set out in Schedule 15 – Output Specifications, or as the Parties may agree) from the date of receipt for Contracting Authority’s review of and response to such Works Submittals;
 - (b) for Works Submittals subject to review by Municipality, including the minimum Works Submittals set out in Appendix B and Appendix E to this Schedule 10, a period of 30 Business Days (or such longer period as may be agreed between Contracting Authority and Project Co) from the date of receipt by Contracting Authority and the Municipality, as applicable, for Contracting Authority’s complete review of and response (in concert with

the Municipality) to each Works Submittal specified in Appendix B and Appendix E to this Schedule 10; and

- (c) for Works Submittals subject to review by [REDACTED], including the minimum Works Submittals as set out in Appendix C to this Schedule 10, a period of 30 Business Days (or such longer period as may be agreed between Contracting Authority and Project Co) from the date of receipt by Contracting Authority and CP, as applicable, for Contracting Authority's complete review of and response (in concert with [REDACTED]) to each Works Submittal subject to review by [REDACTED] as set out in Appendix C to this Schedule 10.

2.3 Intentionally Deleted.

2.4 If, at any time:

- (a) Intentionally Deleted;
- (b) Project Co submits an unusually large number or volume of Works Submittals not contemplated by the Baseline Works Schedule; or
- (c) a Works Submittal was, or Works Submittals were, received for review later than indicated in the Baseline Works Schedule, such that the Contracting Authority Representative cannot review the Works Submittal or Works Submittals within the time permitted in the Baseline Works Schedule,

then the Contracting Authority Representative shall, within five Business Days following receipt of such Works Submittal or Works Submittals, provide Project Co with a reasonable estimate of the time necessary for processing such Works Submittal or Works Submittals.

2.5 For the purposes of this Schedule 10, any Business Days that are between,

- (a) December 20th, 2019 through to January 3rd, 2020;
- (b) December 18th, 2020 through to January 1st, 2021;
- (c) December 17th, 2021 through to January 1st, 2022; and
- (d) December 23rd, 2022 through to January 6th, 2023

shall not constitute Business Days for the purposes of this Schedule 10 – Review Procedure.

3. GENERAL REQUIREMENTS FOR WORKS SUBMITTALS

3.1 Unless otherwise specified by the Contracting Authority Representative, Project Co shall issue all Works Submittals to Contracting Authority, in accordance with the requirements specified in Appendix A to this Schedule 10, Appendix B to this Schedule 10, Appendix C to this Schedule 10, Appendix D to this Schedule 10 or Appendix E to this Schedule 10 as applicable, or as prescribed by Contracting Authority acting reasonably, including an electronic copy in native file format if

- requested by the Contracting Authority Representative and one printed copy of each Works Submittal to the Independent Certifier.
- 3.2 Intentionally Deleted.
- 3.3 All Works Submittals shall be in English.
- 3.4 All Works Submittals required by the Project Agreement or by Applicable Law to be signed or sealed by persons with professional designations (including, where applicable, by registered professional engineers, professional geo-scientists or architects) shall be so signed and sealed.
- 3.5 All Works Submittals shall:
- (a) include copies of all documents to be reviewed; and
 - (b) shall clearly identify the purpose of the Works Submittal, Project Co's proposed course of action relating to the Works Submittal and the Works that are the subject of the Works Submittal.
- 3.6 All Works Submittals shall, where applicable, refer to and be in accordance with:
- (a) the relevant provisions of the Output Specifications, any other applicable Schedule to the Project Agreement and to any Design Data that has previously been subject to review; and
 - (b) the relevant provisions of Appendix A and Appendix D to this Schedule 10 for the process and approvals protocols (including design submission milestones) for items submitted to Contracting Authority, as applicable.
 - (c) the relevant provisions of Appendix B and Appendix E to this Schedule 10 for the process and approvals protocols (including design submission milestones) for items to be submitted for Municipality review, as applicable.
 - (d) the relevant provisions of Appendix C to this Schedule 10 for the process and approvals protocols (including design submission milestones) for items to be submitted for CP review, as applicable.
- 3.7 Each Works Submittal shall be clearly identified as a Works Submittal and shall be delivered with appropriate covering documentation, submitted in both soft and hard copy, which shall include a list of all attached Works Submittals and, for each Works Submittal:
- (a) identification of whether the Works Submittal contains New Metrolinx Infrastructure, or New Third Party Infrastructure;
 - (b) identification of whether the Works Submittal has been submitted pursuant to Appendix A to this Schedule 10, Appendix B to this Schedule 10, Appendix C to this Schedule 10, Appendix D to this Schedule 10 or Appendix E to this Schedule 10;
 - (c) the document number(s) or drawing number(s);

- (d) revision numbers;
 - (e) document or drawing title(s);
 - (f) name of entity that prepared the Works Submittal;
 - (g) name and signature of the Key Individual(s) responsible for content of the Works Submittal;
 - (h) the Works Submittal history, including reviewer and checker initials, date and delivery information, log number of all previous submissions of that Works Submittal, Project Agreement provisions, comments from reviewers from the previous Works Submittal, all outstanding comments, and responses to addressing those comments, all submitted in a format determined by Contracting Authority; and
 - (i) identification of any previous Works Submittal superseded by the current Works Submittal.
- 3.8 To facilitate Contracting Authority distribution of Works Submittals to the Municipality, all Works Submittals that are to be reviewed by the Municipality shall be separated accordingly and submitted individually, to the extent possible. Project Co shall ship any required printed copies directly to each reviewing recipient's identified point of contact.
- 3.9 To facilitate Contracting Authority distribution of Works Submittals to CP, all Works Submittals that are to be reviewed by CP shall be separated accordingly and submitted individually, to the extent possible.
- 3.10 Each Works Submittal shall be organized and shall have indexes and sectional dividers. Each Work Submittal shall contain pertinent correspondence, shall be arranged by subject matter in chronological order, and shall include the final calculations, reports and backup information. All Works Submittals shall include, without limitation, copies of all final approvals, design reports, correspondence and calculations, in both electronic and hard copy.
- 3.11 All Works Submittals shall include sufficient information to demonstrate that Project Co has met its obligations with respect to the Output Specifications.
- 3.12 If a Proposal Part corresponds to a Works Submittal, then Project Co shall ensure that its initial submission of such Works Submittal in accordance with this Schedule 10 is substantially the same content and level of detail as the corresponding Proposal Part. For clarity, this requirement shall not,
- (a) lessen, reduce or otherwise modify or amend Contracting Authority's rights under the Project Agreement to review each Works Submittal in accordance with this Schedule 10; or
 - (b) constitute acceptance or comment by the Sponsors of any Proposal Part or any Works Submittal in accordance with Schedule 10 – Review Procedure.

4. COMMENTS

- 4.1 The Contracting Authority Representative shall review and respond to each Works Submittal in accordance with the time periods specified in Section 2.2(a) or 2.2(b), as applicable. The Contracting Authority Representative shall return Works Submittals to Project Co with a copy to the Independent Certifier and assign one of the following four comments:
- (a) “NO COMMENT”;
 - (b) “MINOR NON-CONFORMANCE”;
 - (c) “MAJOR NON-CONFORMANCE”; or
 - (d) “CRITICAL NON-CONFORMANCE”.
- 4.2 The comment “NO COMMENT” will be assigned to each Works Submittal that, in the opinion of the Contracting Authority Representative, generally conforms to the requirements of the Project Agreement. Project Co shall comply with and implement such Works Submittal.
- 4.3 For each Works Submittal that requires approval from third parties, including, for clarity, approval from the Municipality, the Contracting Authority Representative may not issue a “NO COMMENT” or a “MINOR NON-CONFORMANCE” comment if the applicable third party has not issued a similar comment to such Works Submittal.
- 4.4 For each Works Submittal that requires approval from third parties, including, for clarity, approval from CP, the Contracting Authority Representative may not issue a “NO COMMENT” or a “MINOR NON-CONFORMANCE” comment if the applicable third party has not approved such Works Submittal.
- 4.5 The comment “MINOR NON-CONFORMANCE” will be assigned to each Works Submittal that, in the opinion of the Contracting Authority Representative, contains any Minor Non-Conformance but does not contain any Major Non-Conformance or Critical Non-Conformance. Project Co shall correct such Works Submittal and shall comply with and implement such Works Submittal after correction, including in accordance with the comments. If the Contracting Authority Representative assigns to a Works Submittal the additional comment “RE-SUBMIT”, Project Co shall correct and re-submit such Works Submittal to the Contracting Authority Representative,
- (a) no later than 20 Business Days after the comment has been provided to Project Co;
 - (b) within the time period set out in Schedule 12 – Works Schedule Requirements in the case of a resubmission of a Progress Works Schedule; or
 - (c) within such longer time period as determined by the Contracting Authority Representative, acting reasonably and as set out in writing.

If at any time it is discovered that Project Co has not corrected the deficiencies on Works Submittals stamped “MINOR NON-CONFORMANCE”, then Project Co will be required to modify the Works Submittals and the Works, including the New Metrolinx Infrastructure or New Third Party

Infrastructure if applicable, as required to ensure that the Works comply with the Output Specifications, any other applicable Schedule to the Project Agreement, and the Project Co Proposal Extracts and Project Co may be required, at the Contracting Authority Representative's discretion, to resubmit the relevant Works Submittals. In such circumstances the Contracting Authority Representative shall act promptly in considering whether such deficiencies have been corrected. No extension of time will be given or additional compensation paid in respect of any such modification or re-submittal.

- 4.6 The comment “MAJOR NON-CONFORMANCE” will be assigned to each Works Submittal that, in the opinion of the Contracting Authority Representative, contains any Major Non-Conformance, but does not contain any Critical Non-Conformance. The comment “CRITICAL NON-CONFORMANCE” will be assigned to each Works Submittal that, in the opinion of the Contracting Authority Representative, contains any Critical Non-Conformance. Project Co shall correct and re-submit such Works Submittal,
- (a) no later than 10 Business Days after the comment “MAJOR NON-CONFORMANCE” or “CRITICAL NON-CONFORMANCE” has been provided to Project Co;
 - (b) within the time period set out in Schedule 12 – Works Schedule Requirements in the case of a resubmission of a Progress Works Schedule; or
 - (c) within such longer time period, as determined by the Contracting Authority Representative, acting reasonably and as set out in writing.

The Contracting Authority Representative will then review such re-submitted Works Submittal and assign a comment to the corrected Works Submittal. The Works Submittal shall be corrected, revised and resubmitted as often as may be required to obtain a comment that permits Project Co to proceed. No extension of time will be given or additional compensation paid in respect of any such modification or re-submittal. In addition to the above, a Works Submittal with a “CRITICAL NON-CONFORMANCE” comment will be a Proceeding At Risk Matter in accordance with Section 14.6(a)(ii) of the Project Agreement.

- 4.7 Where the Contracting Authority Representative issues the comment “MINOR NON-CONFORMANCE”, “MAJOR NON-CONFORMANCE” or “CRITICAL NON-CONFORMANCE”, the Contracting Authority Representative shall provide reasons for the comment, referencing the particulars of the Section(s) of the Project Agreement that the Works Submittal fails to satisfy, and, if requested by the Project Co Representative, the Contracting Authority Representative shall meet with the Project Co Representative to discuss the reasons for the comment.
- 4.8 If, at any time after assigning any comment to a Works Submittal, the Contracting Authority Representative or Project Co discovers any significant deficiencies or any failure to conform to the requirements of the Project Agreement, the Contracting Authority Representative may revise the comment assigned to any Works Submittal. If the Parties agree or if it is determined in accordance with Section 5 that the revised comment is correct, Project Co shall make all such corrections to the Works Submittals and the Works. No extension of time will be given or additional compensation paid in respect of any such modification or re-submittal.

- 4.9 For the purpose of facilitating and expediting the review and correction of Works Submittals, the Contracting Authority Representative and the Project Co Representative shall meet as may be mutually agreed to discuss and review any outstanding Works Submittals and any comments thereon.
- 4.10 Where a Works Submittal is voluminous, the Contracting Authority Representative at his or her discretion may elect to issue the appropriate comment only to the cover page or first sheet of the Works Submittal, if any, and return to Project Co the cover page or first page together with individual pages or sheets on which comments are made, together with an explanation of the status of all pages not returned to Project Co. Any pages returned without such an explanation as to their status shall be deemed to be “NO COMMENT” by Contracting Authority.
- 4.11 In lieu of returning a Works Submittal, the Contracting Authority Representative may, by letter, notify Project Co of the comment assigned to the Works Submittal and if such comment is “MINOR NON-CONFORMANCE”, “MAJOR NON-CONFORMANCE” or “CRITICAL NON-CONFORMANCE”, the letter shall contain comments in sufficient detail for Project Co to identify the correction sought.

5. DISPUTES

- 5.1 If Project Co disputes any act of Contracting Authority or the Contracting Authority Representative in respect of a Works Submittal under this Schedule 10 – Review Procedure, Project Co shall promptly notify the Contracting Authority Representative and the Independent Certifier of the details of such Dispute and shall submit the reasons why Project Co believes a different comment should be assigned, together with appropriate supporting documentation. The Contracting Authority Representative shall review the Works Submittal, the reasons and supporting documentation and within five Business Days after receipt thereof shall either confirm the original comment or notify Project Co of a revised comment. If the Contracting Authority Representative confirms the original comment, Project Co may request that the Independent Certifier resolve the Dispute and render a decision within five Business Days following such request.
- 5.2 If either Party is not satisfied, acting reasonably, with the resolution of the Independent Certifier, subject to Section 10.2, either Party may refer the matter for determination in accordance with Schedule 27 - Dispute Resolution Procedure.
- 5.3 Notwithstanding the provisions of Sections 5.1 and 5.2, the Contracting Authority Representative may direct that Project Co revise the Works Submittals in accordance with the comments of the Contracting Authority Representative and proceed to perform and complete the Works on the basis of such revised Works Submittals. For clarity, such direction shall be considered a Dispute and Project Co may proceed in accordance with this Section 5 and Schedule 27 – Dispute Resolution Procedure.

6. EFFECT OF REVIEW

- 6.1 Any review and comment by Contracting Authority or the Contracting Authority Representative of any Works Submittals are for general conformity to the obligations and requirements of the Project Agreement, and any such review and comment shall not relieve Project Co of the risk and responsibility for the Works and for meeting all of Project Co’s obligations under and requirements

of the Project Agreement, and shall not create any new or additional obligations or liabilities for Contracting Authority. Without limiting the generality of the foregoing, any and all errors or omissions in Works Submittals or of any review and comment shall not exclude or limit Project Co's obligations or liabilities in respect of the Works under the Project Agreement or exclude or limit Contracting Authority's rights in respect of the Works under the Project Agreement.

7. WORKS SUBMITTAL EXPLANATION

7.1 At any time, the Contracting Authority Representative may, acting reasonably, require Project Co or any Project Co Parties, including Project Co's consultants and any other relevant personnel, at no additional cost to Contracting Authority, to explain to the Contracting Authority Representative and Contracting Authority's advisors the intent of Project Co's Works Submittals, including in relation to any design and any associated documentation and as to its satisfaction of the Output Specifications or any other Schedule to the Project Agreement, as applicable. Project Co shall provide the explanation to the Contracting Authority Representative within five Business Days (or such longer period as the Parties may agree) from the date of receipt of the request from the Contracting Authority Representative.

8. REVISIONS

8.1 Project Co shall ensure that Works Submittals keep the same, unique reference number throughout the review process, and that subsequent revisions of the same Works Submittal are identified by a sequential revision number. Correspondence related to such Works Submittal shall reference the reference number and revision number.

8.2 Re-submittals shall clearly show all revisions from the previous Works Submittal. For printed copies, bound documents, including reports and manuals, shall contain a preface that clearly states how revisions are marked and the previous revision number against which the revisions have been marked. Project Co shall use a consistent format for mark-ups of documents (for example, deletions struck out and additions underscored). Project Co shall clearly mark revised portions of drawings (with appropriate means to visually distinguish between the parts of the drawing that are revised and the parts that are not revised) and shall include the revision number and description of the revision on the drawing.

8.3 Re-submittals shall include all required revised documents, all documents submitted in the previous Works Submittal that do not require revisions and all responses to comments provided by Contracting Authority associated with the Works Submittal.

8.4 Project Co shall ensure that all revisions on print media be initialed by hand by the individual designer, design checker and, where applicable, by the drafter and the drafting checker and identify the persons who initialed the Works Submittal. Electronic versions of the Works Submittal shall identify the persons who initialed the revisions to the printed version of the Works Submittal. All such revisions must be able to be integrated into the Record Drawings.

8.5 Project Co shall keep all Design Data current, including a current set of the most recently issued submittal documents available on Site in the construction trailer for use by Contracting Authority and the Contracting Authority Representative. If any Design Data is revised as part of a Works Submittal, all other Design Data relying on or based on that Design Data shall also be revised

accordingly. All such revised Design Data shall also be submitted with the Works Submittal to which it relates.

- 8.6 Works Submittals that are replacements in kind shall keep the original submittal number with the next sequential revision number.

9. AUDIT BY THE CONTRACTING AUTHORITY REPRESENTATIVE

- 9.1 Without limiting any other right under the Project Agreement, the Contracting Authority Representative shall have the right to audit all Works Submittals, including comparing all Works Submittals to previous Works Submittals.

- 9.2 If during an audit or at any other time it is discovered by Contracting Authority or Project Co (or resolved pursuant to Section 9.3) that any Works Submittals were not correctly implemented, Project Co shall at its sole cost immediately take all necessary steps to correct and modify the applicable Works Submittals and the Works to which they relate and shall advise the Contracting Authority Representative of all such corrections and modifications.

- 9.3 Any Dispute concerning the implementation of a Works Submittal, subject to Section 5.1, shall be referred in the first instance to the Independent Certifier for resolution.

10. VARIATIONS

- 10.1 No alteration or modification to the design, quality and quantity of the Works arising from the development of detailed design or from the co-ordination of the design in connection with any Works Submittal shall be construed or regarded as a Variation.

- 10.2 If, having received comments from the Contracting Authority Representative on any Works Submittal, Project Co considers that compliance with those comments would amount to a Variation, Project Co shall, within 10 Business Days following receipt of and before complying with the comments, provide written Notice to Contracting Authority of the same and, if it is agreed by the Parties that a Variation would arise if the comments were complied with, Contracting Authority may, at their election,

- (a) issue a Variation Enquiry (and it shall be dealt with in accordance with Schedule 22 - Variation Procedure); or
- (b) amend their comment on the Works Submittal.

If the Parties do not agree that a Variation would arise if the comments were complied with, either Party may proceed to resolve the matter in accordance with Section 5.3, including for clarity, the exercise by Contracting Authority of its rights under Section 5.3. Subject to the foregoing sentence, any failure by Project Co to notify Contracting Authority in accordance with this Section 10.2 that Project Co considers that compliance with any comments of the Contracting Authority Representative would amount to a Variation shall constitute an irrevocable acceptance by Project Co that any compliance with the Contracting Authority Representative's comments shall be without cost to Contracting Authority and without any extension of time.

11. GENERAL

- 11.1 Any capitalized terms used in the appendices to this Schedule 10 – Review Procedure, that are not defined in this Schedule 10 – Review Procedure or in Schedule 1 – Definitions and Interpretation, shall have the meanings given to them in Schedule 15 – Output Specifications or Schedule 17 – Environmental Obligations.

APPENDIX A

MINIMUM WORKS SUBMITTALS

1. FORMAT FOR WORKS SUBMITTALS

1.1 Project Co shall submit Works Submittals listed in **Table A-1 – Minimum Works Submittals** of this Schedule 10, in accordance with the following formats:

(a) hard copy requirements:

- (i) five (5) sets of reduced format drawings (11” x 17”, fold-outs, folded to 8.5” x 11”) and Design Briefs included in a 3-hole ring binder;
- (ii) two (2) sets of large format drawings (A0 or A1 size) shall be provided separately (bound) that are Issued for Construction drawings or Record Drawing; and
- (iii) five (5) sets of Works Submittals which are not drawings shall be submitted in 8.5” x 11” black and white format as follows, unless otherwise specifically noted in this Appendix A (or as requested by Contracting Authority Representative, acting reasonably); and

(b) soft copy requirements:

- (i) Works Submittals shall be in electronic format (text-searchable PDF copies of all deliverables and native-file format) and stored on a USB storage device as follows;
 - (A) each USB storage device shall contain an electronic copy of each of the Works Submittals, including PDF copies of all deliverables, native file format of all drawings and .dwg files for all submitted sheets. CAD formats shall be native files of Autodesk Civil3d, AutoCAD and Revit. All .dwg files, including exports for submitted sheets from Revit and Civil3D, shall be fully compatible with Metrolinx CAD systems in accordance with Metrolinx’s CADD/BIM Standards Manual. The current Metrolinx CAD system is AutoCAD 2015. All data shall comply with the following coordinate systems: (i) NAD_1983_MTM_10 EPSG:2952 and (ii) Vertical Reference Datum CGVD1928:78 Adj.

(B) any Works Submittal based on Microsoft Excel or other software shall be submitted in the native format;

(ii) all Works Submittals shall be uploaded to Contracting Authority’s Web Based Project Management System in text-searchable PDF format and native-file format at the same time that any such Works Submittals are forwarded to Contracting Authority.

1.2 Project Co shall submit any Works Submittals, including those not described in Appendix A, Appendix B, Appendix C, Appendix D, and Appendix E to this Schedule 10, in accordance with the format set out in Appendix A.

2. SUBMITTALS

2.1 The following is a non-exhaustive list of Works Submittals that Project Co shall provide to Contracting Authority for review and comment in accordance with this Schedule 10. Each Works Submittals shall be delivered with appropriate covering documentation in the format set forth in Section 3.7 of this Schedule 10

2.2 Additional Works Submittals may be requested by the Contracting Authority Representative at any time in order to understand the Works, and Project Co shall be required to provide them to Contracting Authority for review in accordance with this Schedule 10. A description of the minimum content of each Works Submittal provided is set out in this Section 2 of this Appendix A.

2.3 Works Submittal deliverables which are applicable to satisfying the requirements of multiple Works Submittal sections are permitted to be reused, granted they meet all the requirements of each Works Submittal section they are applied to.

[REDACTED]

APPENDIX B

MINIMUM WORKS SUBMITTALS – MUNICIPALITY REVIEW

1. FORMAT FOR WORKS SUBMITTALS

1.1 Project Co shall submit Works Submittals identified in **Table B-1 – Minimum Works Submittals for Municipality Review** of this Schedule 10 in accordance with the following formats:

(a) hard copy requirements:

- (i) twelve sets of reduced format drawings (11”x 17”, fold-outs, folded to 8.5” x 11”) and Design Briefs included in a 3-hole ring binder;
- (ii) four sets of large format drawings (A0 or A1 size) shall be provided separately (bound);
- (iii) twelve sets of Works Submittals which are not drawings shall be submitted in 8.5” x 11” black and white format as follows, unless otherwise specifically noted in this Appendix B (or as requested by Contracting Authority Representative, acting reasonably);

(b) soft copy requirements, in addition to hard copies:

- (i) three sets of Works Submittals shall be included in electronic format (text-searchable PDF and native-file format) and stored on three sets of USB storage devices as follows;
 - (A) each USB storage device shall contain an electronic copy of each of the Works Submittals, including PDF copies of all deliverables, native file format of all drawings and .dwg files for all submitted sheets. CAD formats shall be native files of Autodesk Civil3D, AutoCAD and Revit. All .dwg files, including exports for submitted sheets from Revit and Civil3D, shall be fully compatible with Metrolinx CAD systems in accordance with Metrolinx’s CADD/BIM Standards Manual. The current Metrolinx CAD system is AutoCAD 2015;
 - (B) any Works Submittal based on Microsoft Excel or other software shall be submitted in the native format;

- (ii) Works Submittals shall be uploaded to Contracting Authority’s Web Based Project Management System in text-searchable PDF format and native-file format at the same time that any such Works Submittals are forwarded to Contracting Authority.

2. SUBMITTALS

- 2.1** The following is a list of the Works Submittals that Project Co shall provide to the Municipality for review and comment in accordance with this Schedule 10.
- 2.2** Additional Works Submittals may be requested by the Contracting Authority Representative or Municipality at any time in order to understand the Works, and Project Co shall be required to provide same to Contracting Authority for review in accordance with this Schedule 10. A description of the minimum content of each Works Submittal provided is set out in this Section 2 of this Appendix B.
- 2.3** Works Submittal deliverables which are applicable to satisfying the requirements of multiple Works Submittal sections are permitted to be reused, granted they meet all the requirements of each Works Submittal section they are applied to.

[REDACTED]

APPENDIX C

**MINIMUM WORKS SUBMITTALS –
CP REVIEW**

1. FORMAT FOR WORKS SUBMITTALS

1.1 Project Co shall submit Works Submittals identified in **Table C-1 – Minimum Works Submittals for CP Review** of this Schedule 10 in accordance with the following formats:

(a) hard copy requirements:

- (i) two sets of large format drawings (A0 or A1 size) shall be provided separately (bound), as well as three sets of reduced format drawings (11” x 17”) organized and compiled in 3-hole ring binders; and
- (ii) three sets of all other non-drawing Works Submittals shall be submitted in 8.5” x 11” black and white, or colour, in a 3-hole ring binder, and any supporting drawings or illustrations shall be reduced format (11” x 17”, fold-outs, folded to 8.5” x 11”) and included within each such submission; and

(b) soft copy requirements, in addition to hard copies:

- (i) three sets of Works Submittals shall be included in electronic format (text-searchable PDF and native-file format) and stored on three sets of USB storage devices as follows:
 - (A) each USB storage device shall contain an electronic copy of each of the Works Submittals, including PDF copies of all deliverables, native file format of all drawings and .dwg files for all submitted sheets. CAD formats shall be native files of Autodesk Civil3d, AutoCAD and Revit. All .dwg files, including exports for submitted sheets from Revit and Civil3D, shall be fully compatible with Metrolinx CAD systems in accordance with Metrolinx’s CADD/BIM Standards Manual. The current Metrolinx CAD system is AutoCAD 2015.
 - (B) any Works Submittal based on Microsoft Excel or other software shall be submitted in the native format;
- (ii) Works Submittals shall be uploaded to Contracting Authority’s Web Based Project Management System in text-searchable PDF format and native-file format at the same time that any such Works Submittals are forwarded to Contracting Authority.

2. SUBMITTALS

- 2.1** The following is a detailed list of the Works Submittals that Project Co is required to provide to Contracting Authority and CP for review and comment in accordance with this Schedule 10.
- 2.2** Additional Works Submittals may be requested by the Contracting Authority Representative or CP at any time in order to understand the Works, and Project Co shall be required to provide same to Contracting Authority for review in accordance with this Schedule 10. A description of the minimum content of each Works Submittal provided is set out in this Section 2 of this Appendix C.
- 2.3** Works Submittal deliverables which are applicable to satisfying the requirements of multiple Works Submittal sections are permitted to be reused, granted they meet all the requirements of each Works Submittal section they are applied to.
- 2.4** All Work Submittals shall be limited in scope to the areas contained within the CP Lands or the Diamond Lands.

[REDACTED]

APPENDIX D

MINIMUM WORKS SUBMITTALS – EARLY WORKS

1. FORMAT FOR WORKS SUBMITTALS

1.1 Project Co shall submit Works Submittals listed in Table D-1 – Minimum Works Submittals for Early Works of this Schedule 10, in accordance with the following formats:

(a) hard copy requirements:

- (i) five sets of reduced format drawings (11” x 17”, fold-outs, folded to 8.5” x 11”) and Design Briefs included in a 3-hole ring binder;
- (ii) two sets of large format drawings (A0 or A1 size) shall be provided separately (bound) that are Issued for Construction drawings or Record Drawing; and
- (iii) five sets of Works Submittals which are not drawings shall be submitted in 8.5” x 11” black and white format as follows, unless otherwise specifically noted in this Appendix D (or as requested by Contracting Authority Representative, acting reasonably); and

(b) soft copy requirements, in addition to hard copies:

- (i) three sets of Works Submittals shall be included in electronic format (text-searchable PDF and native-file format) and stored on a USB storage device as follows;
 - (A) each USB storage device shall contain an electronic copy of each of the Works Submittals, including PDF copies of all deliverables, native file format of all drawings and .dwg files for all submitted sheets. CAD formats shall be native files of Autodesk Civil3d, AutoCAD and Revit. All .dwg files, including exports for submitted sheets from Revit and Civil3D, shall be fully compatible with Metrolinx CAD systems in accordance with Metrolinx’s CADD/BIM Standards Manual. The current Metrolinx CAD system is AutoCAD 2015;
 - (B) any Works Submittal based on Microsoft Excel or other software shall be submitted in the native format;

- (ii) all Works Submittals shall be uploaded to Contracting Authority’s Web Based Project Management System in text-searchable PDF format and native-file format at the same time that any such Works Submittals are forwarded to Contracting Authority.

2. SUBMITTALS

- 2.1** The following is a non-exhaustive list of Works Submittals that Project Co shall provide to Contracting Authority for review and comment in accordance with this Schedule 10.
- 2.2** Additional Works Submittals may be requested by the Contracting Authority Representative at any time in order to understand the Works, and Project Co shall be required to provide them to Contracting Authority for review in accordance with this Schedule 10. A description of the minimum content of each Works Submittal provided is set out in this Section 2 of this Appendix D.
- 2.3** Works Submittal deliverables which are applicable to satisfying the requirements of multiple Works Submittal sections are permitted to be reused, granted they meet all the requirements of each Works Submittal section they are applied to.

[REDACTED]

APPENDIX E

MINIMUM WORKS SUBMITTALS – EARLY WORKS FOR MUNICIPALITY REVIEW

1. FORMAT FOR WORKS SUBMITTALS

1.1 Project Co shall submit Works Submittals listed in Table E-1 – Minimum Works Submittals for Early Works for Municipality Review of this Schedule 10, in accordance with the following formats:

(a) hard copy requirements:

- (i) twelve sets of reduced format drawings (11”x 17”, fold-outs, folded to 8.5” x 11”) and Design Briefs included in a 3-hole ring binder;
- (ii) four sets of large format drawings (A0 or A1 size) shall be provided separately (bound);
- (iii) twelve sets of Works Submittals which are not drawings shall be submitted in 8.5” x 11” black and white format as follows, unless otherwise specifically noted in this Appendix E (or as requested by Contracting Authority Representative, acting reasonably);

(b) soft copy requirements, in addition to hard copies:

- (i) three sets of Works Submittals shall be included in electronic format (text-searchable PDF and native-file format) and stored on three sets of USB storage devices as follows:
 - (A) each USB storage device shall contain an electronic copy of each of the Works Submittals, including PDF copies of all deliverables, native file format of all drawings and .dwg files for all submitted sheets. CAD formats shall be native files of Autodesk Civil3D, AutoCAD and Revit. All .dwg files, including exports for submitted sheets from Revit and Civil3D, shall be fully compatible with Metrolinx CAD systems in accordance with Metrolinx’s CADD/BIM Standards Manual. The current Metrolinx CAD system is AutoCAD 2015;
 - (B) any Works Submittal based on Microsoft Excel or other software shall be submitted in the native format;

- (C) Works Submittals shall be uploaded to Contracting Authority’s Web Based Project Management System in text-searchable PDF format and native-file format at the same time that any such Works Submittals are forwarded to Contracting Authority.

2. SUBMITTALS

- 2.1** The following is a list of the Works Submittals that Project Co shall provide to the Municipality for review and comment in accordance with this Schedule 10.
- 2.2** Additional Works Submittals may be requested by the Contracting Authority Representative or Municipality at any time in order to understand the Works, and Project Co shall be required to provide same to Contracting Authority for review in accordance with this Schedule 10. A description of the minimum content of each Works Submittal provided is set out in this Section 2 of this Appendix E.
- 2.3** Works Submittal deliverables which are applicable to satisfying the requirements of multiple Works Submittal sections are permitted to be reused, granted they meet all the requirements of each Works Submittal section they are applied to.

[REDACTED]

**ATTACHMENT 1
SAMPLE DESIGN CERTIFICATES**

DESIGN CERTIFICATE (GENERAL)

In respect of: **(Provide submittal details)**

Project Agreement between Contracting Authority and Project Co dated XX XX, XXXX (“the Project Agreement”) relating to the Project. Defined terms and expressions used in the Project Agreement have the same meanings in this Certificate.

Form of Certificate to be used by the Design Team for certifying the design of the Works to the extent that such Works components have been constructed, installed, altered, upgraded, and/or augmented, in accordance with Schedule 15 – Output Specifications.

1. We certify that we have the requisite professional qualifications, skill and experience to prepare the Design Data referred to herein in accordance with the requirements of the Project Agreement and all relevant Output Specifications.

2. We certify that we have prepared the Design Data for [.....] listed in the Schedule hereto in accordance with all applicable requirements contained in the Design Quality Management Plan and utilizing the standards of care, skill and diligence that, in accordance with the standards of our profession, are required of experienced professionals undertaking the preparation of such Design Data, and that in our professional opinion such Design Data:
 - (a) complies with all applicable Output Specifications, as amended by the following:
 - (i) **[List, if any, the changes made by the issue of Variation(s)];**
 - (b) complies with all applicable design requirements of the Project Agreement;
 - (c) complies with all applicable standards, codes and current Good Industry Practice; and
 - (d) accurately describes and depicts the Works to be undertaken.

SCHEDULE

[Include here drawing numbers and titles, reports, calculations, etc.]

Certified by:

Design Team (Principal)

Name:

Title:

Date:

Professional Registration Number:

Affix Professional Seal

Signed:

Construction Contractor representative

Name:

Date:

This Design Certificate is assigned as:

- i. no comment*
- ii. minor non-conformance*
- iii. major non-conformance*
- iv. critical non-conformance*

* delete as appropriate

Signed:

Contracting Authority Representative

Name:

Date:

Certificate Ref No. []

DESIGN CERTIFICATE (ENVIRONMENTAL)

Project Agreement between Contracting Authority and Project Co dated XX XX, XXXX (“the Project Agreement”) relating to the Project. Defined terms and expressions used in the Project Agreement have the same meanings in this Certificate.

Form of certificate to be used by the Design Team and the Environmental Director for certifying the design of environmental works incorporated in the Works in accordance with the Project Agreement.

1. We certify that we have the requisite professional qualifications, skill and experience to prepare the Design Data referred to herein in accordance with the requirements of the Project Agreement and all relevant Output Specifications.
2. We certify that we have prepared the Design Data for [.....] **[Name and list of all elements of the environmental works]** in the Schedule hereto in accordance with all applicable requirements contained in the **[Design Quality Management Plan]** and utilizing the standards of care, skill and diligence that, in accordance with the standards of our profession, are required of experienced professionals undertaking the preparation of such Design Data, and that in our professional opinion:
 - (a) the said Design Data complies with all applicable Output Specifications, including Technical Appraisal Form No. [.....] dated [.....], as amended by the following:
 - (i) **[List, if any, the changes made by the issue of Variation(s), and any Addenda to the foregoing Technical Appraisal Form];**
 - (b) the said Design Data complies with all applicable design requirements of the Project Agreement;
 - (c) the said Design Data complies with all applicable standards, codes and current Good Industry Practice; and

the said Design Data accurately describes and depicts the Works to be undertaken.

SCHEDULE

[Include here drawing numbers and titles and reports, calculations, etc.]

Certified by:

Design Team (Principal)

Name:

Title:

Date:

Professional Registration Number:

Affix Professional Seal

Signed:

Environmental Director

Name:

Title:

Date:

Professional Registration Number:

Affix Professional Seal

This Certificate is assigned as:

- i. no comment*
- ii. minor non-conformance*
- iii. major non-conformance*
- iv. critical non-conformance*

* delete as appropriate

Signed:

Contracting Authority Representative

Name:

Date:

ATTACHMENT 2

Sample Construction Certificate

CONSTRUCTION CERTIFICATE

Project Agreement between Contracting Authority and Project Co dated XX XX, XXXX (“the Project Agreement”) relating to the Project. Defined terms and expressions used in the Project Agreement have the same meanings in this Certificate.

Form of Certificate to be used by the Design Team for certifying, as applicable:

- (a) the Interim Completion of Construction Activities in respect of those components of the Works set out in paragraph 1 of this Construction Certificate;
- (b) the Substantial Completion of Construction Activities in respect of those components of the Works set out in paragraph 1 of this Construction Certificate;
- (c) the total completion of Construction Activities in respect of the Works, including Interim Minor Deficiencies and Minor Deficiencies; or
- (d) the total completion of Construction Activities in respect of any Reinstatement Work carried out by the Construction Contractor pursuant to Section 11.9 of the Project Agreement, in accordance with a Reinstatement Plan,

in accordance with Schedule 15 – Output Specifications.

Construction Contractor’s Statement

1. We certify that **[name and element of the Works in respect of the Interim Completion Certificate] [name and element of the Works in respect of the Substantial Completion Certificate][the Works in respect of the Final Completion Certificate][the Works in respect of the Final Completion Certificate (Reinstatement Work)]** has been designed, constructed, **[substantially completed], [totally completed]**, commissioned and tested in all respects in accordance with: *[Note to Proponents: Inapplicable language to be deleted.]*
 - (a) the relevant Design Data and Design Certificates in each case to which there has been no objection under the Review Procedure; and
 - (b) the provisions of the Project Agreement, including all applicable Output Specifications, as amended by the following Variation(s):
 - (i) **[List, if any, the changes made by the issue of Variation(s), and any Addenda to the foregoing Technical Appraisal Form];**

Signed

Construction Contractor representative

Name

Date

Design Team’s Statement

1. We certify that we have examined the **[name and element of the Works in respect of the Interim Completion Certificate] [name and element of the Works in respect of the Substantial Completion Certificate][the Works in respect of the Final Completion Certificate][the Works in respect of the Final Completion Certificate (Reinstatement Work)]** in accordance with the requirements for examination of the Works contained in the **[Design Quality Management Plan]** and the **[Construction Quality Management Plan]** and utilizing the standards of care, skill and diligence that, in accordance with the standards of our profession, are required of experienced professionals undertaking such examinations, and that in our professional opinion **[the said element of the Works][the Works]** has been designed, constructed, **[substantially completed][totally completed]**, commissioned and tested in accordance with: *[Note to Proponents: Inapplicable language to be deleted.]*
 - (a) the relevant Design Data and Design Certificates in each case to which there has been no objection under the Review Procedure; and
 - (b) the provisions of the Project Agreement, including all applicable Output Specifications, as amended by the following Variation(s):

[List, if any, the changes made by the issue of Variation(s), and any Addenda to the foregoing Technical Appraisal Form];

Signed

Design Team (Principal)

Name

Title

Date

Professional Registration Number:

Affix Professional Seal

Receipt of this Certificate is acknowledged.

Signed

Independent Certifier

Name

Date

Professional Registration Number:

Affix Professional Seal

This Certificate is assigned as:

- i. no comment*
- ii. minor non-conformance*
- iii. major non-conformance*
- iv. critical non-conformance*

* delete as appropriate

Signed:

Contracting Authority Representative

Name:

Date:

**SCHEDULE 11
QUALITY MANAGEMENT**

[REDACTED]

SCHEDULE 12

WORKS SCHEDULE REQUIREMENTS

[REDACTED]

Project Schedules Checklist

Project Agreement - Schedule 12 - Appendix F

Project Name: _____
 Project Schedule Name: _____ Rev _____
 Reviewer: _____ Review Date: _____ Signature (Reviewer) _____

DRAFT

Requirement	Conformance?		
	Y	N	n/a

1. Revision and Change management

Schedule Revision Date conforms			
Schedule Progress Date conforms			

2. Submission requirements

Minutes of the Workshop meeting included?			
Project Schedule register included?			
Quality Audit report included (Works Schedule)			
Project Schedule format is correct.			
Primavera P6 (.XER), Trimble TILOS and PDF file received			
Schedule reviewed and signed by Project Co Representative			
Filename correct (e.g. "ABC Updated Works Schedule Rev 05 – 20151031")			

3. Conformance to general Schedule Technical Requirements

Schedule is created in Primavera 6.0 and Trimble TILOS 6.0, or other software as agreed with Contracting Authority			
Title block contains the correct information.			
Activities grouped in separate stages, with each stage or series of linked stages resulting in achieving a Key Works Milestone.			
Activity codes used for responsible entity, stage, and section/location (unique coding)			
Activities roll up properly (summary data is generated correctly)			
Colour coding and appropriate formatting is used to facilitate understanding			
All activities are of the "task dependent type"			
Any "WBS Summary" activity type can be deleted without impacting the Critical Path			
Automatic resourcing functionality was not used			
Working hours reflect the actual allowable working hours on site			
No Global calendars used, only Project specific calendars complying to the requirements. (descriptive name, week starts on Monday, non-working days included, start and finish times etc.)			
Number of calendars used shall be minimized			
Confirm the appropriateness of the calendar type used for lags (setting in Primavera). Replace lags with activities wherever possible, as lags have only one calendar option in Primavera 6.0			
No fractional work activity durations. (e.g. may not be 5.5 days)			
Baseline Works Schedule: Number of Critical Path activities is less than 30% of total activities			
Baseline Works Schedule: Number of near critical activities (less than 10 days float) is less than 50% of total activities			
Activities are detailed enough so that:			
No activity has a value greater than 5% of total construction value			
Key Works Activities Min. 1 or < 180 calendar days			
Primary Works Activities Min. 1 < 90 calendar days			
Secondary Works Activities Min. 1 < 20 calendar days			
Micro-Schedule Activities Min. 1 < 5 calendar days			
Critical Path:			
Critical path indicated to achieved SC, and each Phase SC			
CP calculated using retained logic methodology			
No "level of effort (Hammock)" type activities included in the CP			
CP result of unmodified software calculation. (i.e. PCo may not use additional filters)			
CP is continuous and logic driven			
Consist only of activities with a float value of zero			
If two CPs are identified using the two standard methods, did Project Co include a narrative proposing which is more relevant?			
Near critical activities are highlighted (when requested by Contracting Authority)			

4. Conformance to general content requirements

Baseline schedule does not include progress information (draft of Works Schedule, Works Schedule, baseline Works Area Micro Schedule)			
Progress information (Applicable to Progress Schedules only):			
Progress percentage represent physical percentage completion			
An actual start date is listed for each activity with % progress registered			
Progress is registered for any activity with an actual start or finish date			

	An actual start and end date is listed for all completed activities			
	Actual finish date is listed for all achieved milestones			
	There is no progress or actual dates listed post the Schedule Status date			
	Separate work stages or phases are clearly identifiable			
	Where a "hammock" is defined, all summary activities and milestones are included			
5. Conformance to general Activity and Milestone coding requirements				
	Each Works Activity and Works Milestone include:			
	(i) a unique activity ID that shall be alpha-numeric starting with a letter			
	(ii) a unique name or description using consistent and intuitive terminology that would be understandable to Contracting Authority and only using activity descriptions that begin with a verb or work function followed by an object. The description shall not include percentages, and shall where applicable contain a location and physical dimension			
	(iii) early and late start dates, each with a starting time set as the intended work start time for each work day, but in any event before noon of the specific day			
	(iv) early and late finish dates, each with a finish time set as the intended work finish time for each work day, but in any event after noon of the specific day			
	(v) actual start and actual finish dates			
	(vi) original planned duration as defined by the Works Schedule in work days			
	(vii) shortest expected activity duration			
	(viii) longest expected activity duration			
	(ix) physical % completion			
	(x) remaining duration			
	(xi) expected finish date			
	(xii) actual duration			
	(xiii) calendar assigned			
	(xiv) total float or slack for the activity			
	(xv) free float for the activity			
	(xvi) relationship with other activities and milestones			
	(xvii) activity or lag			
	(xviii) Quantity representing the primary physical dimension			
	(xix) Quantity unit, which shall be "units", "m", "m2", "m3" or "sum";			
	(xx) User defined field(s) "StartLocation"			
	(xxi) User defined field(s) "EndLocation"			
	(xxii) User defined field "works_location"			
	(xxiii) User defined field "responsible"			
	(xxiv) User defined field "works_phase"			
	Activity and Milestone Relationships:			
	"hammock" activities have a SS relationship with the first activity in the series			
	"hammock" activities have a FF relationship with the last activity in the series			
	each works activity has a start and finish relationship			
	each works activity has at least one predecessor and one successor			
	The start-to-finish (SF) activity type is not used (unless agreed with Contracting Authority)			
	for each start milestone only define a finish-to-start (FS) or start-to-start (SS) relationship with its predecessor, a start-to-start (SS) or start-to-finish (SF) relationship with its successor, a start-to-start (SS) relationship with any other start milestone, or a start-to-finish (SF) relationship to a finish milestone			
	for each finish milestone only define a finish-to-finish (FF) or start-to-finish (SF) relationship with its predecessor, a finish-to-start (FS) or finish-to-finish (FF) relationship with its successor, a finish-to-start (FS) relationship to any other start milestone, or a finish-to-finish (FF) with any other finish milestone			
	not use a negative lag between any Works Activities and/or Works Milestones			
	not use positive lag between Works Activities or Works Milestones on a Finish-to-Start (FS) activity type, for clarity, if for any reason the next activity cannot start for a specific period after the preceding activity has finished, e.g. due to concrete curing etc, then such an event shall be indicated as an activity and indicated in the schedule using the appropriate logic unless the Project Agreement requirements specifically allows otherwise			
	for any two Works Activities with a start-to-start (SS) relations define a lag no longer than the duration of the predecessor duration			
	not use reverse logic, for clarity, a Works Activity shall not have a finish-to-finish relationship with a predecessor, and a Works Activity shall not have a start-to-start (SS) relationship with a successor			
	only define one relationship per activity or milestone pair, except for the finish-to-finish (FF) and start-to-start (SS) relationship pair that may used together for an activity or milestone pair			

	No date constraints used, except for the first "Financial Close" milestone, or otherwise agreed to by Contracting Authority. When used only the start-no-earlier, or finish-no-later than type			
	Cost Loading (Only the Works Schedule and Progress Works Schedules)			Not Applicable
	Construction Payment milestone shown in separate section			Not Applicable
	Value of all Construction Payment milestones equal to the DBJV contract value			Not Applicable
	All Works Activities are cost loaded			Not Applicable
	All Works Activities are linked to one of the Construction Payment Milestones			Not Applicable
	The cost of all Works Activities equal the Construction Contractor contract value			Not Applicable
	Project Co provided the Planned Value (PV), Earned Value (EV), and Schedule Performance Index (SPI) all plotted on an S-Curve			Not Applicable
6. conformance to Works Submittal requirements (Look-ahead Schedule)				
	All Works Submittals for the period is listed			
	At least the minimum Contracting Authority Review Period was schedule for each submittal			
	No more than 2 Works Submittals per discipline for review on any specific day			Not Applicable
	Works Submittal Contracting Authority Review Period linked to actual Works activities			
	There is a time buffer between the Contracting Authority Review Period and the related activity on site			
7. draft of the Works Schedule and Works Schedule specific requirements				
	Schedule Progress Date = Financial Close date			
	No progress data for any activity or milestone			
	Does not include any delay information, and all activities encoded as if any delay did not take place			
	The Contracting Authority owned schedule buffer of "x" days is included as the last activity before SC			
	All Key Works milestones included in separate section at the top of the Schedule			
	Specific sections as specified separately included (i.e. traffic management)			
	All Key Works Activities included			
	All Primary Works Milestones included			
	All Primary Works Activities included			
	Conforming Works Schedule Assumptions report included			
	Blacklined version of previous Works Schedule Assumption report included			
8. Works Schedule Assumptions report conformance				
	Report includes:			
	Implementation strategy			
	Critical Path risk			
	Planned working calendars			
	Means and Methods			
	Resource plan			
	Planned Production rates			
	General assumptions			
9. Works Schedule Progress Report conformance				
	Report includes:			
	Executive Summary			
	Schedule Analysis			
	Variances			
	Potential Delay events (cause by either party)			
	Contracting Authority involvement in next 8 week period			
	Contracting Authority Submittal review register			
	Progress photos			
10. Progress Works Schedule specific requirements				
	Validity (Current Progress Works Schedule)			
	Schedule Status Date and Schedule Revision date is not older than 15 Business Days following the previous month			
	Works on site is reflected in the schedule in terms of actual activity, actual start and finish dates, and actual progress as of the Schedule Status Date			
	Includes:			
	all elements from Works Schedule			
	current progress as of the Schedule Status date			
	Works Schedule indicated as a baselines (second line against current strategy)			
	implementation of each Variation Confirmation			
	agreed potential Delay events			
	recover plan to mitigate delays			

11. Look-ahead Schedule specific requirements				
Validity (Current Look-ahead Schedule)				
Schedule Status Date and Schedule Revision date is not older than 15 Business Days following the previous month				
Works on site is reflected in the schedule in terms of actual activity, actual start and finish dates, and actual progress as of the Schedule Status Date				
Works Milestone and Works Activity dates correspond to the Current Progress Works Schedule				
Contracting Authority Review Periods conform to requirements				
The correct time period, and correct activities and milestones for the period are shown				
Includes:				
all elements from Progress Works Schedule				
Commissioning Activities				
Design Development Activities				
Equipment Procurement and Installation Activities				
Secondary Works Milestones				
Secondary Works Activities				
Systems Commissioning Activities				
Permitting, Licensing and Approval Activities				
Project Close Activities				
Review Procedure activities (in separate section)				
Major and Critical Non-conformance rectification activities (in separate section)				
12. Works Area Micro Schedule				
Validity Check:				
Works Milestone and Works Activity dates correspond to the Current Progress Works Schedule				
Includes (for the specific area of Works):				
all elements from Progress Works Schedule				
all elements from Look-ahead Schedule				
Micro-Schedule Works Milestones				
Micro-Schedule Activities				
Drawing of the affected area (if requested by Contracting Authority)				
13. Assumptions				
Work durations consider lesser initial productivity and learning curves				
non-work windows are properly defined (allowance for inclement weather, environmental restrictions, public holidays etc.)				

SCHEDULE 13

PROJECT CO PROPOSAL EXTRACTS

These Project Co Proposal Extracts are in the nature of clarifications, interpretations and/or enhancements to the design and construction requirements of the Output Specifications and, as such, are not intended to conflict with, lessen, reduce or otherwise modify or amend the provisions of Schedule 15 – Output Specifications. The intention of these Project Co Proposal Extracts is to reflect and capture certain Proposal Parts for the benefit of Contracting Authority and Project Co. For greater certainty, in the event of any ambiguities, conflicts or inconsistencies between or among any of the provisions of these Project Co Proposal Extracts and the remainder of the Project Agreement, Section 1.2 of the Project Agreement shall apply.

The Parties acknowledge and agree that nothing in these Project Co Proposal Extracts will limit Project Co’s obligation to perform and complete the Works in accordance with the Project Agreement, including but not limited to, the provisions of Schedule 15 – Output Specifications, and that nothing in these Project Co Proposal Extracts represents a final or approved form of any listed design concept, configuration or drawing.

Project Co acknowledges and agrees that any items, submittals and documents arising from these Project Co Proposal Extracts shall be submitted to, reviewed or otherwise processed by Contracting Authority in accordance with the Schedule 10 – Review Procedure, and in the event that they are identified as being non-compliant they shall be brought into compliance with the Project Agreement at Project Co’s sole cost and expense and without any Variation or amendment to the Works Schedule.

The Proposal Part extract is set out below and is hereby incorporated into and forms part of the Project Co Proposal Extracts:

- The grating detail captured from GCRS’ RFP proposal, *Figure 2.1.7.B – Typical Detail for the Direct Fixation Track System*, illustrating the typical grating to be provided between plinths, as per the dashed area indicated below:

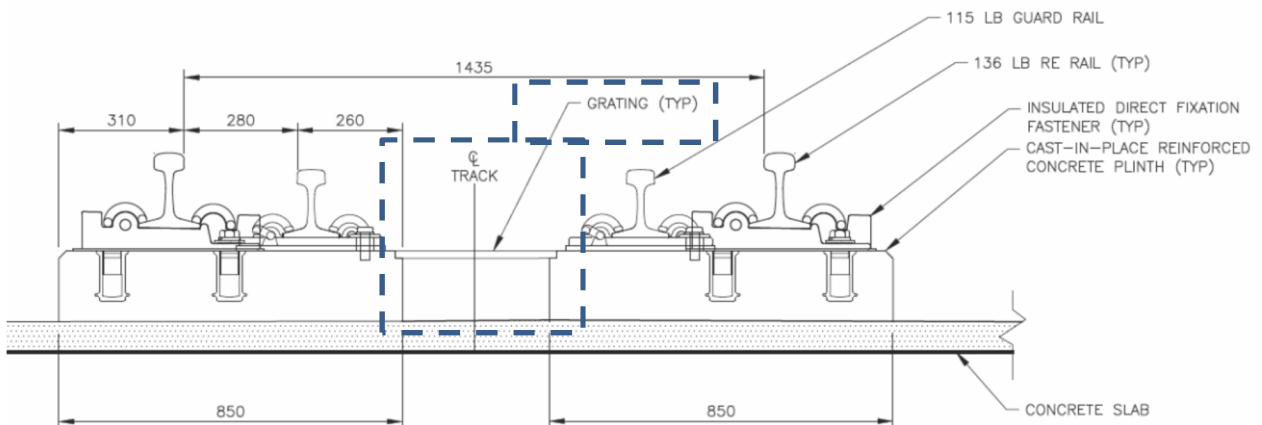

- For clarity plinth dimensions, rail profiles, track gauge and spacing, and direct fixation fasteners do not form part of this Project Co Proposal Extract.

SCHEDULE 14

OUTLINE COMMISSIONING PROGRAM AND HANDOVER

[REDACTED]

SCHEDULE 16
ENCUMBRANCES

- (a) For purposes of this Schedule 16, the defined term “Lands” shall include any portion of the Lands.
- (b) Each of the following, to the extent affecting the interest (whether real property interest or contractual interest) of Metrolinx in the Lands, is considered to be an encumbrance for the purposes of the Project Agreement (each, an “**Encumbrance**”):
- (i) All encumbrances, pledges, liens, charges, security agreements, security interests, leases, subleases, title retention agreements, mortgages, easements, encroachments, right-of-ways, restrictive covenants, work orders, options or adverse claims of any kind or character whatsoever relating to the title to the Lands disclosed or noted on the land registry office parcel registers or abstract indices for the Lands from time to time, including (but not limited to) those that may have been included in the Background Information as of the date of the Project Agreement and including those referred to in the legal descriptions for the Lands available in the applicable land registry office, in each case as assigned, amended, extended, supplemented, substituted and replaced from time to time.
 - (ii) Liens, charges or prior claims for taxes (which term includes charges, rates and assessments) or utilities (including levies or imposts for sewers and other municipal utility services) not yet due or if due, the validity of which is being contested in good faith, and liens or charges for the excess of the amount of any past due taxes or utilities charges for which a final assessment or account has not been received over the amount of such taxes or utilities charges as estimated and paid by Contracting Authority.
 - (iii) Inchoate liens incidental to construction, renovations or current operations, a claim for which shall not at the time have been registered against the Lands or of which notice in writing shall not at the time have been given to Contracting Authority pursuant to the Construction Act or otherwise or any lien or charge, a claim for which, although registered, or notice of which, although given, relates to obligations not overdue or delinquent and in respect of any of the foregoing cases, Contracting Authority has, where applicable, complied with the holdback or other similar provisions or requirements of the relevant construction contracts.
 - (iv) The rights reserved to or vested in the public or any municipality or governmental or other public authority by any statutory provision.
 - (v) Any subsisting reservations, limitations, provisions and conditions contained in any grants from the Crown of any land or interests therein, including reservations of under-surface rights to mines and minerals of any kind including rights to enter, prospect and remove the same.
 - (vi) Any encroachments, easements, rights of way, rights to use or similar interests revealed by any survey of the Lands or which would be revealed by an up-to-date survey of the Lands.

- (vii) Any rights in favour of or accruing to holders of under-surface rights which could be ascertained by a review of registered title or other public records, or, if unregistered, which do not materially interfere with the use of the Lands for the purposes of the Works.
- (viii) Unregistered agreements with any municipal, provincial or federal governments or authorities and any public utilities or private suppliers of services, provided such unregistered agreements have been disclosed to Project Co, or which could be ascertained by commercially standard off-title searches, or, if not so disclosed or ascertained, which do not materially interfere with the use of the Lands for the purposes of the Works, and further provided such agreements have been complied with, or, if not complied with, that any non-compliance does not materially interfere with the use of the Lands for the purposes of the Works.
- (ix) Unregistered agreements, authorizations, consents, postponements, subordinations, licences or instruments entered into provided that they have been disclosed to Project Co, or which could be ascertained by commercially standard off-title searches, or, if not so disclosed or ascertained by commercially standard off-title searches, or, if not so disclosed or ascertained, which do not materially interfere with the use of the Lands for the purposes of the Works, and further provided such agreements have been complied with, or, if not complied with, that any non-compliance does not materially interfere with the use of the Lands for the purposes of the Works.
- (x) Unregistered easements, rights of way, rights to use, restrictions, restrictive covenants and similar rights in real property or any interest therein provided that they have been disclosed to Project Co, or which could be ascertained by commercially standard off-title searches, or, if not so disclosed or ascertained by commercially standard off-title searches, or, if not so disclosed or ascertained, which do not materially interfere with the use of the Lands for the purposes of the Works, and further provided such agreements have been complied with, or, if not complied with, that any non-compliance does not materially interfere with the use of the Lands for the purposes of the Works.
- (xi) Minor imperfections of title.
- (xii) Statutory exceptions to title and any rights reserved to or vested in any person by any statutory provision.
- (xiii) The right of any prior owner, occupant or tenant of any portion of the Lands to occupy any portion of the Lands or to remove buildings, fixed machinery, equipment, fittings or other fixtures located on such portion of the Lands.
- (xiv) The rights of any person entitled to any portion of the Lands through length of adverse possession or prescription.

**SCHEDULE 17
ENVIRONMENTAL OBLIGATIONS**

[REDACTED]

SCHEDULE 18
COMMUNICATION AND PUBLIC ENGAGEMENT PROTOCOL

1. DEFINITIONS

In this Schedule 18 – Communication and Public Engagement Protocol, unless the context indicates a contrary intention, terms which are defined in the Project Agreement (and not otherwise defined in this Schedule 18 – Communication and Public Engagement Protocol) shall have meanings given to them in the Project Agreement and the following terms shall have the following meanings:

- 1.1 “*Accessibility for Ontarians with Disabilities Act*” means the *Accessibility for Ontarians with Disabilities Act*, 2005, S.O. 2005, c. 11, as amended from time to time.
- 1.2 “**Communications and Public Engagement Protocol**” means this Schedule 18.
- 1.3 “**Communications Working Group**” has the meaning given in Section 7.1(a).
- 1.4 “**Community Engagement and Stakeholder Relations Plan**” has the meaning given in Section 4.2(a).
- 1.5 “**Complaints Protocol**” has the meaning given in Section 5.9(b)(i).
- 1.6 “**Construction Activities Incident**” has the meaning given in Section 6(e).
- 1.7 “**Construction Communication Liaison(s)**” means the individual employed by Project Co as a communications liaison worker for the Project, with the function set out in Schedule 9 – Key Individuals.
- 1.8 “**Contracting Authority Community Liaison Representative**” means any individual(s) employed by Contracting Authority as community liaison worker(s) for the Project who are stationed in the community office, or at Metrolinx’s offices during the Project Term.
- 1.9 “**Crisis Communication Plan**” has the meaning given in Section 5.3(a).
- 1.10 “**Project Co Communications Protocol**” has the meaning given in Section 3.1(a).
- 1.11 “**Project Co Communications Team**” has the meaning given in Section 3.1(a)(ii).

2. GENERAL

2.1 Communications Principles

- (a) The Project represents an important transit infrastructure commitment by Contracting Authority. As Project Co carries out its responsibilities under the Project Agreement, comprehensive community and stakeholder relations plans are required to ensure the public is informed and engaged where necessary and to meet Contracting Authority’s communications requirements. These communications and stakeholder relations plans will support effective timely, transparent

communications between Project Co and Contracting Authority, and stakeholders, local businesses, residents and the public during the Project Term.

- (b) Project Co acknowledges that,
 - (i) Project Co is Contracting Authority’s primary source of information with respect to all matters within Project Co’s control in respect of the Project; and
 - (ii) Contracting Authority and the Stakeholders, at all times during the Project Term, shall rely upon Project Co not only to anticipate matters which may be of interest and concern to Stakeholders during the Project Term (based on its experience as well as lessons learned during the course of the Project), but also to proactively organize and disseminate such information in accordance with its obligations in the Project Agreement so as to permit the Parties to perform their obligations hereunder.
- (c) The communications and community engagement objectives of the Project are as follows:
 - (i) to provide regular and timely updates during the Project Term in order to communicate construction progress, project highlights, potential traffic changes and other traffic to the public, and to generally enhance opportunities for open, transparent, effective and proactive communications with the public so as to minimize complaints and increase the public’s understanding of the Project;
 - (ii) to ensure that Stakeholder input is obtained in a timely manner so that it may be properly considered by the Parties, and to provide the Stakeholders with regular and timely information in respect of Project status and progress, potential traffic or transit system changes and noise, dust, vibration, congestion, impacts on businesses, residents, and customers and other actual and potential impacts of Project activities;
 - (iii) to be accountable to the Stakeholders for the effective implementation of communications and community engagement plans as set out in the Project Agreement; and
 - (iv) to recognize the contribution of the Parties with respect to the Project.
- (d) Contracting Authority and Project Co shall work together to deliver these communications and public engagement activities pursuant to the Project Agreement, including this Schedule 18.
- (e) The scope of this Schedule 18 includes but is not limited to all print, event and electronic communications related to: planning, design, Works, Project milestones, community and stakeholder relations, public information meetings, branded products, Project website (www.metrolinx.com/RER or future dedicated project website), social media, complaints and issues related to the Project and any responses to such complaints or issues.

3. GENERAL COMMUNICATIONS RESPONSIBILITIES

- (a) Project Co shall,
 - (i) carry out all activities required to fulfill all of Project Co’s communications and community engagement obligations in accordance with and as set out in this Schedule 18;

- (ii) develop all plans, protocols, and other documentation that Project Co is required to develop in accordance with this Schedule 18 in consultation with Contracting Authority, Stakeholders, and Governmental Authorities, and submit all such plans, protocols and documentation to Contracting Authority for review in accordance with Schedule 10 – Review Procedure;
- (iii) in consultation with Contracting Authority, Stakeholders, and Governmental Authorities, implement and comply with all plans, protocols and other documentation that have been reviewed and approved by Contracting Authority in accordance with this Schedule 18;
- (iv) provide all information, materials, support and consultation to Contracting Authority as Contracting Authority may require with respect to Contracting Authority’s communications, public engagement, community liaison and public notification activities, Stakeholder consultation, and reporting related to the Project as the Project is designed, constructed, and commissioned;
- (v) be available to assist Contracting Authority in responding to media, government and public enquiries related to the Project as requested and in accordance with all timelines prescribed by Contracting Authority;
- (vi) review and develop communications and/or technical materials reasonably requested by Contracting Authority;
- (vii) provide regular updates to Contracting Authority related to the management of local traffic, Site, and pedestrians during the Project Term;
- (viii) provide experienced communications and public engagement staff, as set out in Section 3.1(a)(ii), to support the implementation of the Community Engagement and Stakeholder Relations Plan, and to participate in the Communications Working Group, internal and external meetings and public events;
- (ix) provide dedicated communications and Project experts to participate in Contracting Authority’s communications meetings and the Communications Working Group;
- (x) consult with Contracting Authority with respect to design opportunities to engage the community in the Project’s design process through workshops, where feasible and as directed by Contracting Authority;
- (xi) support Contracting Authority in making communications materials accessible to the public;
- (xii) work with all Project Co Parties, Contracting Authority, and other Stakeholders of the Project, including the Municipality, MTO and other Governmental Authorities, Utility Companies, Railway Companies, Municipal Transit Systems, Emergency Service Providers, neighbourhood groups (property owners, ratepayers, citizens), local businesses (individual operators and business improvement areas) and various community interest groups (environmental, health, natural and cultural heritage, advocacy) in carrying out Project Co’s obligations as set out in this Schedule 18; and

- (xiii) ensure that Project Co and Project Co Parties exhibit a high degree of professionalism and courteousness with respect to carrying out all of Project Co's obligations under this Schedule 18, including,
 - (A) attendance at public consultations and events;
 - (B) staff and contractor parking that will not negatively impact neighbourhood access;
 - (C) not littering; and
 - (D) making reasonable amends to replace or rehabilitate any personal or private property that becomes damaged as a result of the Project, plantings and signage should these items become damaged.
- (b) Project Co acknowledges and agrees that, notwithstanding any other provision in this Schedule 18,
 - (i) all communications-related protocols, plans, materials, advertisements, notices, activities, approaches and strategies with respect to the Project, shall be subject to Contracting Authority's review and approval and, as applicable, the approval of the Municipality and Governmental Authorities; and
 - (ii) Contracting Authority retain the right to review all communications and communications-related materials with respect to the Project, and Project Co may not make any communication or disseminate any materials to the public with respect to the Project without the prior consent of Contracting Authority.

3.1 Project Co Communications Protocol

- (a) Project Co shall, no later than 60 days following Financial Close, submit a communications protocol for review by Contracting Authority pursuant to Schedule 10 - Review Procedure that describes how Project Co will meet its communications-related obligations under the Project Agreement during the Project Term (the "**Project Co Communications Protocol**"). The Project Co Communications Protocol shall include the following:
 - (i) an executive summary of objectives with list of tactics and description of Project Co's approach to all communications aspects of the Project;
 - (ii) a description of Project Co's dedicated communications team (the "**Project Co Communications Team**"), including the roles, responsibilities and experience of each team member and Project Co Party who will assist in any aspect of the Project Co Communications Protocol. The Project Co Communications Team shall be comprised of no less than two full time staff (including the Construction Communication Liaison(s)), and Project Co shall provide any additional staff required in order for Project Co to fulfill its communications obligations under the Project Agreement. Each member of the Project Co Communications Team shall possess a minimum of three to five years, of transit, construction related, or equivalent public engagement experience;
 - (iii) a summary of proposed communication tools to be used by Project Co to consult with and report to Contracting Authority in accordance with this Schedule 18, with a view towards

ensuring that a system is in place for media and community relations, issues management, complaints management, dispute resolution and crisis communications for the purposes of informing and engaging the community, businesses and other stakeholders about the progress of the Project, as well as any impacts and the benefits of the Project; and

- (iv) a summary of Project Co's proposed plan with respect to notifying, in consultation with Contracting Authority, affected residents and businesses, including Contracting Authority's community relations representatives, as soon as possible of unplanned or unexpected impacts of the Works (including by going door-to-door and providing updates for Contracting Authority's Project website (www.metrolinx.com/RER or future dedicated project website) and updated messages on Contracting Authority's existing information telephone line and 3-1-1 for after-hours support), and provide an estimate of the expected duration of the impact.
- (b) Project Co shall update the Project Co Communications Protocol,
- (i) every year; or
 - (ii) more frequently as may be requested by Contracting Authority, or as may be required to account for any changes in the circumstances of or lessons learned with respect to the Project.

Project Co shall resubmit each updated Project Co Communications Protocol to Contracting Authority for review pursuant to Schedule 10 - Review Procedure.

4. COMMUNITY ENGAGEMENT DURING THE PROJECT TERM

4.1 General

During the Project Term, public engagement activities shall be conducted by Contracting Authority and Project Co on a range of topics, some of which will be overarching and apply to the length of the Project (for example, design, urban design, landscaping and aesthetics, resident impacts, public spaces, access points to community), while others may be more staged, topic or geographic area-specific (for example, Environmental Assessments, noise mitigation, dust control, access to affected business and changes in service). The nature or form of the public engagement may vary based on the topic being addressed.

4.2 Community Engagement and Stakeholder Relations Plan

- (a) No later than 90 days following Financial Close and, prior to initiating any communications related activity or disseminating any communications-related materials, Project Co shall submit a community engagement and Stakeholder relations plan with respect to the Project Term for review by Contracting Authority pursuant to Schedule 10 - Review Procedure that describes how Project Co will meet its communications-related obligations under the Project Agreement during the Project Term (the "**Community Engagement and Stakeholder Relations Plan**"). The Community Engagement and Stakeholder Relations Plan shall include,
 - (i) a description of Project Co's strategies and tactics to support,

- (A) initiatives for public engagement and consultation for a minimum of 12 events or meetings per year, and which may increase as per the discretion of the Contracting Authority; and
 - (B) local or community based communications, advertising and notification related to the Works;
 - (ii) a description of the communications activities as set out in Section 5, including a description of how Project Co will carry out such communications activities in accordance with its obligations set out in this Schedule 18 and in order to meet its obligations to support communications and community engagement strategies and activities; and
 - (iii) a description of Project Co's approach and strategy with respect to carrying out its obligations as set out in Section 4.3.
- (b) Project Co shall update the Community Engagement and Stakeholder Relations Plan
- (i) on a quarterly basis; or
 - (ii) more frequently as may be requested by Contracting Authority, or as may be required to account for any changes in the circumstances of or lessons learned with respect to the Project.

Project Co shall resubmit each updated Community Engagement and Stakeholder Relations Plan to Contracting Authority for review pursuant to Schedule 10 - Review Procedure.

4.3 Project Co's Community Engagement and Stakeholder Relations Obligations

- (a) Project Co shall,
- (i) in consultation with Contracting Authority, provide Contracting Authority with support of public engagement events or meetings for the Project, including, supporting individual plans and materials for public engagement meetings or events;
 - (ii) attend upon request by Contracting Authority, with representatives of Contracting Authority, Stakeholder meetings, municipal council meetings and presentations, and such other meeting or events as Contracting Authority deem necessary, draft meeting materials for review by Contracting Authority, and present, if requested by Contracting Authority;
 - (iii) provide technical staff for involvement and participation in community events and meetings, including,
 - (A) Key Individuals;
 - (B) a facilitator;
 - (C) architects;
 - (D) urban designers;

- (E) landscape architects;
 - (F) noise and vibration specialists; and
 - (G) other technical staff as requested by Contracting Authority;
- (iv) in consultation with Contracting Authority, determine how Stakeholder input shall be considered, responded to, and/or accommodated in the Project, including provision of respectful, meaningful, and timely feedback to those providing comments and ideas;
 - (v) provide any necessary information required to demonstrate compliance with and fulfillment of the consultation;
 - (vi) in order to allow local residents and businesses easy access to information about progress, Works, mitigation measures and other Project information, provide support to Contracting Authority, as well as dedicated communications staff in accordance with Section 3.1(a)(ii) to work out of existing or new Contracting Authority’s community store-front office;
 - (vii) make staff available to respond to enquiries from the public and Stakeholders about the Works;
 - (viii) in consultation with Contracting Authority, provide regular updates to the immediately affected property owners, tenants and neighbourhoods on Works-related issues with particular attention to communicating the scope, schedule and status of the Works. This will include processes to proactively address any Works-related enquiries and issues (for example, public enquiries and complaints regarding noise, hours of work, dust, etc.);
 - (ix) support Contracting Authority in arranging meetings, in advance, with residents and businesses where Project Co requires access to properties; and
 - (x) maintain a written record of all public enquiries, complaints and communications and provide copies to Contracting Authority’s lead communications contact on a weekly basis (or immediately if urgent) as per the Complaints Protocol, as set out Section 5.9.

5. COMMUNICATIONS ACTIVITIES

5.1 Communications Activities - General

- (a) Project Co shall support the following communication tactics during the Project Term as deemed necessary by Contracting Authority, including,
 - (i) Project website and social media (Metrolinx.com/RER or future dedicated project website);
 - (ii) crisis communications;
 - (iii) public meetings;
 - (iv) public workshops;

- (v) issues management;
- (vi) special events;
- (vii) signage;
- (viii) Project identity and graphic design;
- (ix) photography and video production;
- (x) the Complaints Protocol; and
- (xi) communication team performance review, including KPI analysis.

5.2 Project Website and Social Media

- (a) During the Project Term, Project Co shall,
 - (i) support,
 - (A) Contracting Authority's Project websites (www.metrolinx.com/RER and www.infrastructureontario.ca) by providing static (written) and dynamic (multimedia) content, by providing, for review and approval by Contracting Authority,
 - (I) a monthly feature web article highlighting, but not limited to, one aspect of the Project including, design, innovations on the Project, feature on local workers, general contractors or local companies, Construction Activities, Project benefits, or community engagement, with a minimum length of 500 words; and
 - (II) up-to-date graphics, photos and video clips as well as time lapse videos showcasing the design of the New Metrolinx Infrastructure and progress of the Construction Activity; and
 - (B) social media content with respect to the Project;
 - (ii) employ social media tools to monitor and analyze public responses to the Project;
 - (iii) provide, for review and approval by Contracting Authority, drafts of proactive and reactive content for responses to crisis situations, immediate issues, public queries or complaints, no later than two hours after Project Co or Contracting Authority becomes aware of any such crisis situation, immediate issue, public query or complaint; and
 - (iv) provide draft advance notification for the purposes of website and social media updates for review and approval by Contracting Authority with respect to meetings, events, initiatives, and Construction Activities that will have a direct impact on roads, traffic and/or transit.

5.3 Crisis Communication

- (a) During the Project Term, Contracting Authority shall, no later than 60 days following Financial Close, develop, in consultation with Project Co, a crisis communications plan that outlines the roles and responsibilities of Project Co, Contracting Authority and other partners as required (for example, the Municipality, Toronto Transit Systems, and MTO) with respect to crisis communications, and identify and rank a list of potential crisis issues that could develop during the performance of the Works (the “**Crisis Communication Plan**”).
- (b) During the Project Term, Project Co shall,
 - (i) consult with and provide assistance to Contracting Authority in Contracting Authority’s development of the Crisis Communication Plan and any updates to the Crisis Communication Plan; and
 - (ii) during a crisis situation, make available sufficient Project Co communications staff and Project resources in order to work effectively with Contracting Authority and the Operator to proactively manage and perform Project Co’s communications responsibilities as set out in this Schedule 18.

5.4 Issues Management

- (a) During the Project Term, Project Co shall consult with and provide reasonable assistance to Contracting Authority and the Operator with respect to,
 - (i) identifying issues and trends as they emerge and develop strategies for tracking, addressing, mitigating, and minimizing issues related to the Project;
 - (ii) developing messages and strategies to address issues and provide accurate and timely information to affected Stakeholders; and
 - (iii) sharing information about potential issues related to the Project with other partners.
- (b) Project Co shall respond to all issues identified by Contracting Authority within a timeframe as determined by Contracting Authority.

5.5 Media Relations

- (a) During the Project Term, Project Co shall,
 - (i) direct all media enquiries and interview requests to Contracting Authority’s lead communications contact, who will determine the organization that is most suitable to respond to the enquiry;
 - (ii) provide draft responses and messaging to Contracting Authority and the Operator, with respect to all media enquiries and interview requests in a timely manner and track each request that Project Co responds to in a media request log;

- (iii) support Contracting Authority and the Operator with respect to all media enquiries and interview requests;
- (iv) provide designated media relations staff (with back up media trained personnel, as required) with 24/7 availability to monitor, draft messaging and respond to enquiries as requested by Contracting Authority and the Operator;
- (v) provide communications training to Project Co staff, including refresher training regarding Contracting Authority's and the Operator's communication protocols and policies for handling media, public, and stakeholder interaction; and
- (vi) make available a Project Co designated media relations staff member and construction manager or similar expert for the purposes of responding to technical matters related to media requests and interview requests if required and as requested by Contracting Authority and the Operator.

5.6 Special Events

- (a) Contracting Authority and Project Co shall collaborate to develop, plan, and coordinate various special events during the Project Term.
- (b) During the Project Term, Contracting Authority shall,
 - (i) lead and organize special events, including tours of the Site and milestone celebrations, costs of which will be borne by Contracting Authority (excluding costs related to shutdown of the Works or accommodations at the Site to organize such events, which shall be borne by Project Co); and
 - (ii) provide at least one week advance Notice to Project Co to support any event described in Section 5.6(b)(i) as requested by Contracting Authority.
- (c) During the Project Term, Contracting Authority shall provide support and direction to Project Co for a minimum of 12 public engagement events or meetings per year, which events or meetings shall be led by Project Co, and which number may increase, at the discretion of Contracting Authority. Project Co's costs of any additional public engagement events or meetings beyond the 12 initial engagements in each year shall, subject to and in accordance with Schedule 22 - Variation Procedure, result in a Variation.
- (d) Project Co shall,
 - (i) during the Project Term and in consultation with Contracting Authority, support public engagement events or meetings in accordance with Section 4.3(a)(i), the costs of which will be borne by Project Co, including costs with respect to,
 - (A) renting the venue, tables, chairs;
 - (B) production of displays, invitations, signage and printed material;
 - (C) providing light refreshments for all attendees;

- (D) print and radio advertising in trade and community and national media outlets as determined by Contracting Authority;
- (E) issuing invitations, tracking RSVPs and administering surveys to ensure engagement of locals in the immediate area;
- (F) using best efforts to ensure that the majority of attendees at each event are residents or individuals associated with a business and/or Stakeholder located within a one kilometre radius of the area;
- (G) providing overall event logistics; and
- (H) supplying computers, projectors, cables, power cords, screens, easels, flip charts, pens, markers, registration and sign in sheets.

5.7 Signage and Livery - Construction Signage

- (a) During the Project Term, Project Co shall
 - (i) provide a signage plan in accordance with Metrolinx’s signage catalogue;
 - (ii) prior to installation, provide to Contracting Authority for approval stamped shop drawings of the sign fabrication and installation details, together with a graphic design mock-up of the signage, location and confirmation of the applicable Permit, Licence, Approval or Agreement;
 - (iii) ensure that Project Co and Project Co Parties comply with the construction and promotional signage requirements set out in the Project Agreement and the Metrolinx branding guidelines;
 - (iv) ensure the government Project signs are visibly displayed along the corridor throughout the Project Term;
 - (v) ensure that all signage is kept in good condition when installed and when not in use;
 - (vi) replace any signage that is damaged by Project Co at Project Co’s expense;
 - (vii) remove graffiti on temporary signage within 48 hours or, in the event that graffiti cannot be removed by means of normal cleaning methods, notify the Contracting Authority Community Liaison Representative who may choose to supply replacement signage, and assist with the installation of any such replacement signage;
 - (viii) upon request from Contracting Authority, Project Co shall design and provide dimensions of hoarding, fencing and barriers to support temporary signage provided by Contracting Authority;
 - (ix) provide personnel to install, remove and relocate signage on an expedited basis if required by Contracting Authority; and

- (x) provide temporary wayfinding and directional signage..

5.8 Photography and Video

- (a) For the purposes of record-keeping and demonstrating the progress of the Project during the Project Term, Project Co shall,
 - (i) twice a month, provide high quality photos, graphics and images of the Project to Contracting Authority for use in publications, presentations and on public websites;
 - (ii) provide high quality video clips of the Project to Contracting Authority for use on Project websites for major Project milestones; and
 - (iii) cause Project Co staff or Project Co Parties to provide consent to Contracting Authority respect to Contracting Authority’s disclosure of photo and video content relating to the Project.
- (b) During the Project Term, Project Co shall, from time to time and as reasonably requested by Contracting Authority or the Operator, facilitate access for designated photographers and videographers.

5.9 Complaints Protocols

- (a) During the Project Term, Contracting Authority shall be responsible for approving all responses to claims, complaints, enquiries and suggestions relating to the Project.
- (b) During the Project Term, Project Co shall,
 - (i) incorporate in the Community Engagement and Stakeholder Relations Plan a complaints protocol addressing how Project Co will deal with and respond to enquiries, suggestions, claims and complaints received with respect to the Project during the Project Term (the “**Complaints Protocol**”), provided that the Project Term Complaints Protocol shall contemplate that all claims, complaints, enquiries and suggestions from GO Transit customers to be dealt with no later than 48 hours following receipt, and that all other claims, complaints, enquiries and suggestions be dealt with no later than five days following receipt;
 - (ii) be responsible for tracking all claims, complaints, enquiries and suggestions received and responses received with respect to the Project;
 - (iii) provide monthly reports on claims and complaints to Contracting Authority, including an analysis of the main areas of concern to claimants and complainants; and
 - (iv) coordinate Project Co’s claim and complaint tracking and complaint reports with any internal claim or complaint tracking and reports established by Contracting Authority with respect to the Project as requested by Contracting Authority.

- (c) Project Co acknowledges and agrees that the handling and resolution of claims and complaints from GO Transit customers may have a significant reputational impact to Metrolinx's business and activities. Accordingly, with respect to any claims or complaints from a GO Transit customer,
 - (i) Project Co shall advise Metrolinx of the claim or complaint immediately following receipt thereof and, in consultation with Metrolinx, abide by the protocol for addressing GO Transit customer claims and complaints set out in the Complaints Protocol; and
 - (ii) Project Co shall cooperate and consult Metrolinx with respect to all conduct, analyses, responses, and resolutions associated with any GO Transit customer claim or complaint.
- (d) Project Co acknowledges and agrees that the Complaints Protocol may be made publicly available at the request of Contracting Authority.

5.10 Performance Review

- (a) Contracting Authority shall review Project Co's performance in its support and successful execution of the protocols, strategies and plans developed for the Project to support overall communications, and community, customer and Stakeholder relations, including KPI results.

6. NOTIFICATION

- (a) With respect to Construction Activities that are reasonably anticipated to have a major impact on third party property owners, Project Co shall,
 - (i) provide Notice to Contracting Authority of such Construction Activities at least three months prior to the commencement of such Construction Activities; and
 - (ii) provide a draft public notification at least two months prior to the commencement of such Construction Activities to Contracting Authority for review.

The draft notices provided by Project Co in accordance with this Section 6(a) shall include a comprehensive list of the elements owned by a third party which Project Co anticipates will have to be removed or relocated by the property owner, what elements can remain on the property, detailed drawings that describes the proposed Construction Activities (including new location of relocated items or impacts that might result from the Construction Activities and restoration plans), proposed timeline for Construction Activities (including duration and anticipated completion), contact information to obtain additional information, and any updates or complaints relating to such Construction Activities.

- (b) With respect to Construction Activities that are reasonably anticipated to have a major impact on transit users, pedestrians, residents, traffic, and/or the public generally, Project Co shall,
 - (i) provide Notice to Contracting Authority of such Construction Activities at least 90 days prior to the commencement of such Construction Activities; and
 - (ii) provide a draft public notification at least 60 days prior to the commencement of such Construction Activities to Contracting Authority for review.

For the purposes of this Section 6(b), “major impact” shall include overnight construction, temporary Construction Activities, road closures, final paving, commissioning activities, privately owned elements to be relocated or removed by Project Co, and transit stop relocations.

- (c) With respect to Construction Activities that are reasonably anticipated to have a medium impact on transit users, pedestrians, residents, traffic, and/or the public generally, Project Co shall,
 - (i) provide Notice to Contracting Authority of such Construction Activities at least 15 Business Days prior to the commencement of such Construction Activities; and
 - (ii) provide a draft public notification at least 10 Business Days prior to the commencement of such Construction Activities to Contracting Authority for review.

For the purposes of this Section 6(c), “medium impact” shall include major intersection work, any disruption to water, gas and/or other utilities, and impacts from noise or dust. For clarity, the notification provided by Project Co pursuant to Section 6(c)(ii) shall be delivered by Contracting Authority to all affected properties by Project Co and in consultation with Utility Companies, as applicable.

- (d) With respect to Construction Activities that are reasonably anticipated to have a minor impact on transit users, pedestrians, residents, traffic and/or the public generally, Project Co shall,
 - (i) provide Notice to Contracting Authority of such Construction Activities at least five Business Days prior to the commencement of such Construction Activities; and
 - (ii) provide a draft public notification at least 48 hours prior to the commencement of such Construction Activities to Contracting Authority for review.

For the purposes of this Section 6(d), “minor impact” shall include lane closures, minor pedestrian detours, and access and driveway work. Project Co shall ensure that access is maintained to properties impacted by the Construction Activities.

- (e) With respect to an incident related to Construction Activities that are reasonably anticipated to have an impact on Project Co employees and contractors, transit users, pedestrians, residents, traffic and/or the public generally, and with respect to which Project Co cannot reasonably provide advance notice of any kind to Contracting Authority or the public (a “**Construction Activities Incident**”), Project Co shall,
 - (i) immediately notify Contracting Authority of such Construction Activities Incident;
 - (ii) provide a draft public notification or messaging no later than two hours following the commencement of such Construction Activities Incident to Contracting Authority for review;
 - (iii) be prepared to provide a public statement with respect to the Construction Activities Incident at the request of Contracting Authority; and

- (iv) be prepared to enact a crisis communications plan in consultation with Contracting Authority and to react quickly to provide an immediate response to the public and Stakeholders.

For the purposes of this Section 6(e), a Construction Activities Incident shall include an accident on site or a major catastrophe.

7. COMMUNICATIONS WORKING GROUP

7.1 Communications Working Group

- (a) Contracting Authority and Project Co shall provide staff to support all communications and public engagement activities related to the Project. These staff will form a communications working group (the “**Communications Working Group**”). The Communications Working Group shall develop and implement all communications plans and public consultation and community engagement activities for the Project. Project Co shall ensure that the Construction Manager, Design Manager and any other staff from Project Co or any Project Co Party that Contracting Authority may require, are made available to support the Communications Working Group as required.
- (b) Within 45 days following Financial Close, the Communications Working Group will convene to discuss the Project Co Communications Protocol and to identify the working relationship, roles and responsibilities matrix, and approvals processes for the Project. The Communications Working Group will provide direction and feedback on communications deliverables and plans expected from Project Co on an ongoing basis.
- (c) The Communications Working Group will meet initially once a month throughout the Project Term (or more frequently if requested by any Party), to plan and implement communications and public engagement strategies for the Project, share information, discuss community relations updates, identify and plan for communications and Project milestones, manage issues and receive schedule updates. Strategies and tactics developed will,
 - (i) provide for timely, open, transparent, effective, consistent and proactive communications with the public and elected officials;
 - (ii) foster and maintain positive and constructive relationships with neighbourhoods, agencies and businesses that may be affected by decisions regarding the scope of the Project as well as Construction Activities; and
 - (iii) build trust and maximize public understanding and support for the Project.
- (d) At least monthly at Communications Working Group meetings, Project Co shall be prepared to present:
 - (i) a calendar outlining various communications deliverables and activities for the next four-month period, including identification and scope of the deliverable or activity being addressed, tactic or tools to be employed, objectives, target audience, timing or dead line, and Project Co resources assigned; and

- (ii) a dashboard to provide regular monthly updates about the Works, including statistics, amount of local investments, number of direct jobs and training through registered apprenticeship programs, schedule and other information that will support Contracting Authority's communications and social media strategies.
- (e) Project Co shall prepare Communications Working Group meeting minutes and distribute to the Contracting Authority Representative within five days following Communications Working Group meetings.

8. ACCESSIBILITY

8.1 Accessibility

- (a) Project Co shall ensure that all communications with respect to the Project comply with the *Accessibility for Ontarians with Disabilities Act* (Ontario).

9. PUBLIC DISCLOSURE AND MEDIA RELEASES

9.1 Public Disclosure and Media Releases

- (a) Neither Project Co nor any of Project Co's Parties shall issue or disseminate any media release, public announcement or public disclosure (whether for publication in the press, on the radio, television, internet or any other medium) relating to the Project, the Project Agreement, Contracting Authority's activities or any related matters, without the prior written consent of Contracting Authority.
- (b) Neither Party shall use the other Party's name or refer to the other Party, directly or indirectly, in any media release, public announcement or public disclosure (whether for publication in the press, on the radio, television, internet or any other medium) relating to the Project, the Project Agreement, Contracting Authority activities or any matter related thereto, without the prior written consent of the other Party.
- (c) Project Co shall comply and shall ensure that all Project Co Parties comply, at all times, with Contracting Authority's media release and publicity protocols or guidelines, as such protocols and/or guidelines are updated by Contracting Authority from time to time.



GO Transit Construction Project Signage

May 2, 2014

To: GO Station Services; GO Capital Infrastructure; GO Customer Care; Metrolinx Strategic Communications

Objective

This Design Standards Protocol will outline the methodology and templates used for construction project signs (billboards). The Protocol is intended to apply to all GO construction projects and activities, and be part of the delivery of the project.

GO construction project signage is intended to promote the value of the project to the customer while giving them a basic understanding of the work we are doing – as per our passenger charter, we are keeping them in the know.

GO station construction project signage, is part of the project communication plan, and one of the ways used to communicate public and customer messaging of on-going construction activity at our stations.

Selection of the template and message is based on the type of construction project, third party funding requirements, and the primary intended audience being public facing or customer facing.

- Public facing: general public; usually driving; basic information on what is being constructed; if rendering is available, it should be used with the gotransit.com/improvements URL
- Customer facing: customers; usually walking toward station/tunnels/platform; provides an overview of the type of improvement, ideally a rendering of the finished product and the gotransit.com/improvements URL to learn more about project specifics.

Where an approved template is not suitable for the intended message or audience, a custom communication message, graphic design, or tool is to be explored by the communication specialist.

This protocol and templates shown will be tailored to address work by other Business Units such as PRESTO, UP Express, and Rapid Transit Implementation.

Roles and Responsibilities

PMPS Signage	Responsible for the process the graphic design, installation, and removal; and coordination with Lead Communication Specialist
Communication specialists	Responsible for sign type, message, and content and coordination with Delivery Group and with PMPS Signage
Delivery Group	Responsible for obtaining a rendering/image that best represents the construction work and uploading the rendering to the appropriate “ftp” site
Station Services	Support on determining site location and installation

Template Design Guidelines

Template Methodology:

- There is one general theme per sign.
- Descriptions will appear only on the solid green background space.
- Category and location/station name is in the header.
- The GO logo is placed in the upper right-hand corner.
- The MX enabler bar will always anchor the signs and will include the Metrolinx logo
- Each sign will push to [GOtransit.com/improvements](https://www.gotransit.com/improvements)
- Where there is not a suitable or available rendering, the template with words only will be used, or appropriate creative will be selected by the designated communication specialist working with graphics.

Graphic Design Development:

- Accessibility considerations and audience visibility will govern the final graphic design.
- All signs must be bilingual except where the copy is too long or where there are two ideas or brands sharing the space. In these cases, there will be 2 signs - French sign right beside the English sign (ex. GO and UP at Weston).
- The most up-to-date project rendering will be the one dominant image on the sign, and the upper right-hand corner will be rounded.

Image Resolution Guidelines:

- Dependent on viewing distance, and size of image.
- Close to the image /sign - high resolution jpeg at 300dpi.
- Sign is going to be further back - resolution of 100-150 dpi.

Installation Guidelines:

- Main signage will be a billboard unless the Signage Services team recommends different execution based on site constraints and audience visibility.
- Signage fabricator will work with CI delivery and station operations on location for installation
- Upon installation, confirmation will be issued to the team, and status updated in the Implementation Plan table and weekly update email from Manager Standards to all stakeholders – CI Managers, Station Ops Managers and Lead Communication Specialist.

Guidelines for graphics on storyboards/station improvements with no rendering:

A. No project rendering to complete typical GO project billboard

- In this case graphics will explore options to make list more visually appealing whether it's using icons to represent specific work instead of checkmark or including image of a train or something (this is in the works with graphics).

B. Rendering exists

- Renderings are to be uploaded, by the Delivery Group, to respective "ftp" site, as per the table below.
- A rendering exists, but there is more work being done than is alluded to with the image

- For example, Erindale got a new parking structure, but also a new station building and resurfaced parking lot. Burlington is getting a new station building, but also improved bus loop and Kiss 'N' Ride. English and French lists would flank the GO billboard (EN right; French left).
- Include 3 of these bullets – 4 at the maximum.

Improvements | Améliorations; [Station Name]; Your station, only better.; Votre gare, version améliorée.

- new station building
- renovated/expanded station building
- more accessibility (or new elevator if that's the only accessibility addition)
- new/longer platform
- more convenient access
- repaved parking lot
- # more parking spots (when not a parking structure)
- more pedestrian access
- new station entrance
- extended/new pedestrian tunnel/new pedestrian bridge
- improved bus loop
- improved Kiss 'N' Ride
- heated shelters

Team Specific “ftp” Site Information:

Web address: <https://vpn.metrolinx.com/contractor>

Password: GOTransit1

Division/Office	FTP Site Username
MMI - Stations	stationinfrastructure
MMI – Parking	parkinginfrastructure
MMI – Bus (was pre-existing)	businfrastructure
RCI – Civil group and Track & Signals group	railinfrastructure
RCI – Rail Facilities	railfacilityinfrastructure
USRC – all	unioncorridorinfrastructure
PMPS – all	designstandards
EPA - all	environmentalprograms

Construction Project Signage Templates

Net New Building/Station Construction



- promote GO service coming to potential customers
- usually there is steady stream of traffic passing by the site

New Parking Structure



- list the total # of new spaces – round #
- built at existing stations

Station Improvements



- all station renovation work apart from adding parking
- includes expansion, interior renovation, accessibility
- also includes entirely new station building

New maintenance and storage facility (bus and trains)



- more reliable service especially as we expand
- there are no customers, but will be vehicular traffic
- copy is long with translation, therefore, we will create 2

Co-branded construction projects

We're improving your station and welcoming Union Pearson Express



- One Image only
- Two lines of copy max
- Logos top right
- Grey MX enabler bar bottom
- Review again in 2015 to use UP logo w/o text spelled out

Projects that fall outside above categories

Mississauga Transitway
We're building an underpass to connect the new Transitway's future Erin Mills and Winston Churchill Stations.

Transitway de Mississauga
Nous construisons un passage inférieur pour lier les gares futures Winston Churchill et Erin Mills du nouveau Transitway.

gotransit.com/improvements

Text only Template

Your station, only better.
Votre gare, en version modernisée.

Coming Soon
Bientôt

gotransit.com/improvements

- Coming Soon decal will be applied ONLY when project has reached the 75% completion mark
- Copy in each decal copy will be bilingual
- Colors for the decals will be: Pantone 337C – Overlay for Coming Soon
- and Pantone 376C – Overlay for Now Open
- Should there be a light background rendering then the decal will be Black with Pantone 337C letters, chosen for maximum contrast with the predominant background colour in rendering.

Your station, only better.
Votre gare, en version modernisée.

Now Open
Ouvert

gotransit.com/improvements

James St. North
gotransit.com/improvements

Coming Soon
Bientôt

GO Train service is on its way!
Le service ferroviaire GO arrive!

Process Flow Chart

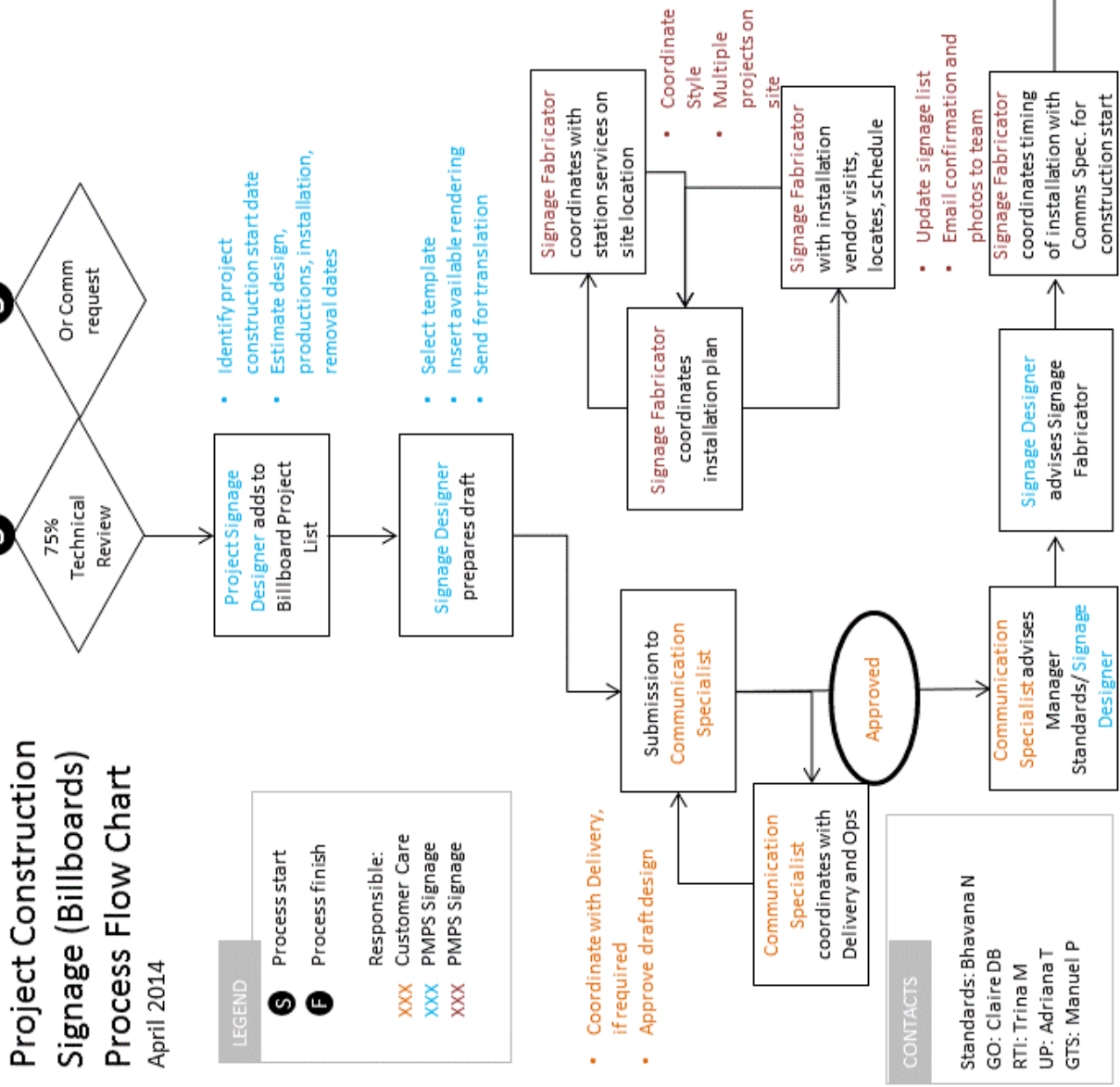
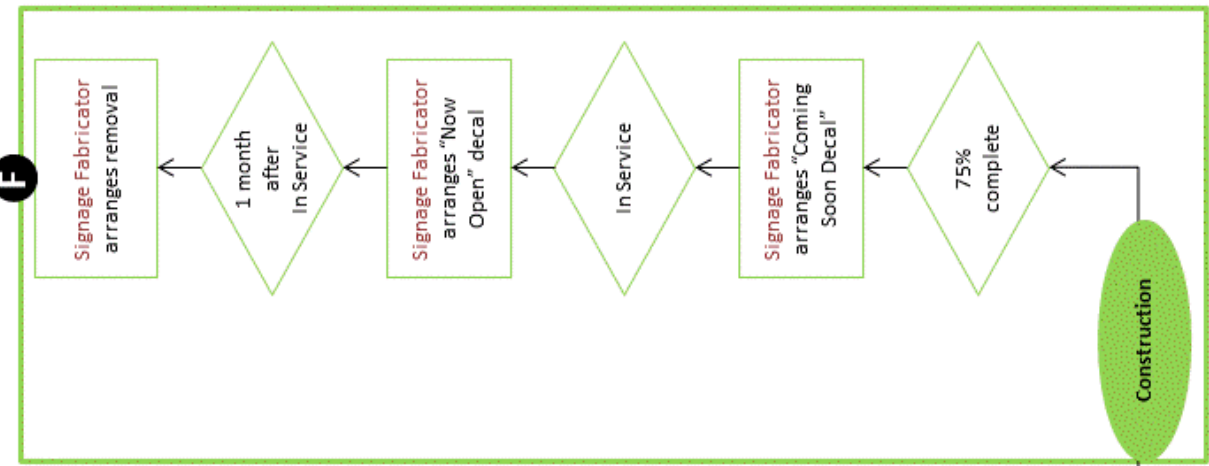

Project Construction Signage (Billboards) Process Flow Chart
April 2014

LEGEND

- S** Process start
- F** Process finish

Responsible:

- XXX Customer Care
- XXX PMPS Signage
- XXX PMPS Signage

- Coordinate with Delivery, if required
- Approve draft design

CONTACTS

Standards: Bhavana N
 GO: Claire DB
 RTI: Trina M
 UP: Adriana T
 GTS: Manuel P

Tracking and Reporting (sample images)

1



GO TRANSIT INFRASTRUCTURE
Project Management & Systems
Design Operations

TECHNICAL REVIEW SCHEDULE

31/10/2012

Location	Description	Contract #	Review Stage	Contractor	Project Comm.	Status	Days Remained from Delivery	Prepared by	W	Tu	We	Th	Fr	Sa	Su	Days Remained to Delivery	Design Review Meeting	
Alex	Parking Rehabilitation		95%	Central	2010-01-01	Under Review	30-Jan-12	10 Days								31-Jan-12	31-Jan-12	8-Feb-12
GTS	North Side		75%	All Other	2010-01-01	Under Review	15-Feb-12	10 Days								20-Feb-12		
Highway 104 Rte 7 & Broad	Ramp and Road Cut		90%	MTCC/CSRF	2010-01-01	Under Review	15-Feb-12	10 Days								20-Feb-12		
Long Branch	Station Sign		75%	Central	2010-01-01	Under Review	15-Feb-12	10 Days								20-Feb-12		

Legend:
■ on
■ not yet
■ not yet
■ not yet
■ not yet

Technical Review Schedule for Signage Designers to trigger start of process

2

CURRENT BILLBOARDS

Location	Project #	Project Name	Project in Service Date (mm/dd/yyyy)	Construction Start Date (mm/dd/yyyy)	Specs/Size	Description/Message	Design Completion Date (mm/dd/yyyy)	Production Completion Date (mm/dd/yyyy)	Installation Date (mm/dd/yyyy)	Removal Date (within 1 month from installation)	Image	Where on Site
Alex	073-40	Parking Structure			4'x8' signs	BCF Funding	on file	on site	11-7-2011		click here for PHOTO	Site Map
Aurora		Building Parking Suburb			4'x4' signs	BCF Funding	on file	7-20-2011	10-15-2011			
		Construction/Access Transit			4'x4' signs	Notice	10-15-2011	10-15-2011	10-16-2011			
Bloor GO Station		Station Expansion			4'x4' signs	BCF Funding	on file	0-11-2011	Not Ready		click here for PHOTO	Site Map
		Station Expansion			4'x4' signs	BCF Funding	on file	0-11-2011	Not Ready		click here for PHOTO	Site Map
Chatham	075775	Parking Structure	3-17-2014	6-18-2012	8'x12' Bifold	Conting Sevens	on file	5-9-2012	7-06-2013	4-37-2014		Site Map
	075775	Parking Structure	3-17-2014	6-18-2012	4'x8' circle	"Now Open" Banner	on file	5-9-2012	7-06-2013	4-37-2014	click here for PHOTO	Site Map
	075775	Parking Structure	3-17-2014	6-18-2012	4'x8' signs	BCF Funding	on file	5-9-2012	7-06-2013	4-37-2014	click here for PHOTO	Site Map
East Gwillimbury	117100	Bus Mgmt Facility	7-1-2014	4-1-2013	6'x8' signs	Conting Sevens	on file	8-28-2013	9-9-2013	8-3-2014	click here for PHOTO	Site Map
	117100	Bus Mgmt Facility	7-1-2014	4-1-2013	4'x4' signs	BCF Funding	on file	in stock	8-16-2012	8-1-2014	click here for PHOTO	
	117100	Bus Mgmt Facility	7-1-2014	4-1-2013	4'x4' signs	BCF Funding	on file	in stock	8-20-2013	9-3-2013	click here for PHOTO	
	117100	Bus Mgmt Facility	7-1-2014	4-1-2013	8'x12' signs	Notice	8-15-2013	8-25-2013	8-3-2013	8-3-2014	click here for PHOTO	Site Map
Frisdale	075775	Parking Structure	3-17-2014	6-18-2012	6'x8' signs	Project ID	7-18-2011	8-19-2011	6-14-2013		click here for PHOTO	Site Map
	075775	Parking Structure	3-17-2014	6-18-2012	4'x4' signs	BCF Funding	on file	7-27-2011	8-20-2011		click here for PHOTO	Site Map
Exhibition		Station Improvements			4'x4' signs	BCF Funding	on file	in stock	8-10-2011		click here for PHOTO	Site Map
Granville GO Station	103709	New Station	3-31-2017	4-1-2011	Proposed 8'x12'	New Station				5-1-2017		
GTS		34 + 4x8' BMT Signs			2 Layers		12-2-2013	12-6-2013	on going			
GTS Black Creek & Photographer Rd.		GTS Train Bridge			6'x8' signs	CSIF Funding	on file	in stock	11-19-2011		click here for PHOTO	Site Map
GTS Black Creek & Weston Rd.		GTS Train Bridge			4'x8' signs	Project ID	1-4-2012	1-10-2012	2-6-2012		click here for PHOTO	Site Map
GTS Black Creek & Weston Rd.		GTS Train Bridge			6'x8' signs	CSIF Funding	on file	in stock	11-19-2011		click here for PHOTO	Site Map
GTS Brock Ave. & Cum.		GTS Train Bridge			4'x4' signs	BCF Funding	on file	in stock	10-7-2013		click here for PHOTO	Site Map
GTS Deacons	090704	Grade Separation	1-10-2011	1-10-2011	8'x12' signs	Conting Sevens	on file	in stock	10-7-2013		click here for PHOTO	Site Map
	090704	Grade Separation	1-10-2011	1-10-2011	6'x8' signs	CSIF Funding	on file	5-4-2011	1-10-2011		click here for PHOTO	Site Map

Internal working list and system inventory

- Summary list will be available and distributed quarterly

3

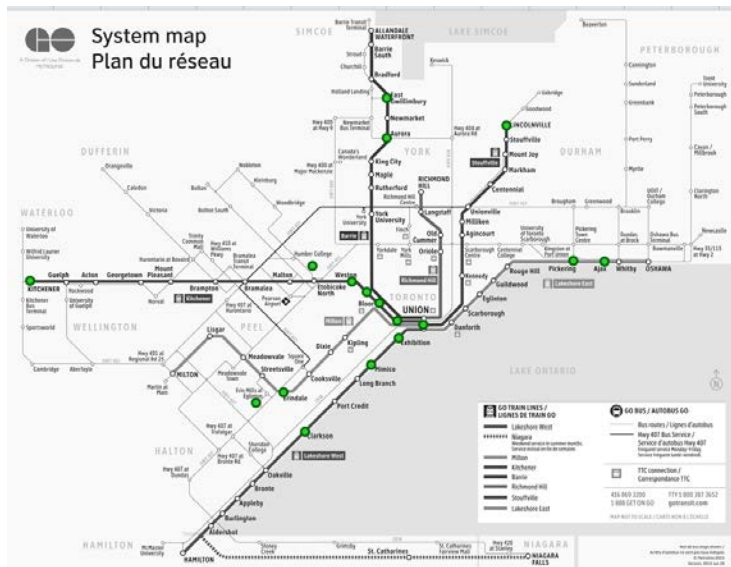

System map showing location of construction project signage

- Update as installations occur; Coming soon to My Lynx

SCHEDULE 19

INTENTIONALLY DELETED

**SCHEDULE 20
LANDS**

PART A – DEFINITIONS AND INTERPRETATION

[REDACTED]

PART B – METROLINX LANDS

[REDACTED]

SCHEDULE 21

LIQUIDATED DAMAGES AND CONSTRUCTION ENFORCEMENT REGIME

1. INTERPRETATION AND DEFINITIONS

1.1 Interpretation

- (a) In this Schedule 21, and for the purposes of all calculations pursuant to this Schedule 21, all amounts cited in respect of capital costs and/or costs in respect of the construction of the Works are amounts prior to any Construction Act holdback.

1.2 Definitions

In this Schedule 21, unless the context indicates a contrary intention, terms which are defined in the Project Agreement (and not otherwise defined in this Schedule 21) shall have meanings given to them in the Project Agreement and the following terms shall have the following meanings:

- (a) “**Additional Major Track Closure**” has the meaning given in Section 3.2(c).
- (b) “**Bala Subdivision**” means the track belonging to CN Railways from Toronto to Rathburn and further extending into the Newmarket Subdivision.
- (c) “**Cancelled Major Track Closure**” has the meaning given in Section 3.2(b).
- (d) “**Construction Period Deduction**” means a deduction for any Construction Period Quality Failure, as calculated in accordance with Section 5.2.
- (e) “**Construction Period Event**” means an incident or state of affairs that does not meet or comply with the Construction Period Performance Criteria, and that is capable of becoming a Construction Period Quality Failure.
- (f) “**Construction Period Failure Category**” means the failure category described in the column entitled “Construction Period Failure Category” in the table set out in Appendix A.
- (g) “**Construction Period Failure Type**” means the failure type described in the column entitled “Construction Period Failure Type” in the table set out in Appendix A.
- (h) “**Construction Period Performance Criteria**” means the level of performance (as set out in the column entitled “Requirement to be Met” in the table set out in Appendix A) that Project Co must achieve to avoid a Construction Period Event for a failure to achieve compliance with the applicable provision of the Project Agreement.
- (i) “**Construction Period Quality Failure**” means any failure by Project Co to provide the services in accordance with any Construction Period Performance Criteria designated as Construction Period Failure Type of “CPQF” as set out in the column entitled “Construction Period Failure Type” in the table set out in Appendix A.
- (j) “**Construction Period Quality Failure Deduction**” has the meaning given in Section 5.2(a).

- (k) **“Contested Non-Conforming Works”** means Works in respect of which Contracting Authority has given Notice to Project Co, pursuant to Section 51 of the Project Agreement (but not a Non-Conformance Report initiated by Contracting Authority pursuant to Schedule 11 – Quality Management), that, in the opinion of Contracting Authority, the Works are not in accordance with the Project Agreement, and Project Co has asserted that, in Project Co’s opinion, the Works are in accordance with the Project Agreement.
- (l) **“CP Train Delay”** has the meaning given in Section 3.3(a).
- (m) **“Critical Construction Period Quality Failure”** means a Construction Period Quality Failure designated as “Critical” in the column entitled “Construction Period Failure Category” in the table set out in Appendix A.
- (n) **“Critical Qualifying NCR”** means a Qualifying NCR raised by Contracting Authority or Project Co on a Non-Conformance that requires all or any portion of Project Co Accepted Works to be removed or repeated because such Project Co Accepted Works have, or would reasonably be expected to have, a significant adverse or material adverse impact on:
- (i) the safety of the Project, the environment, System Users or the public;
 - (ii) the quality of the Works; or
 - (iii) the durability of the Works.
- (o) **“Critical Qualifying Process NCR”** means a Qualifying Process NCR raised by Contracting Authority or Project Co on a Non-Conformance that requires physical progress on any part of Works to be stopped for longer than 24 hours.
- (p) **“Failure to Vacate”** has the meaning given in Section 3.2(a).
- (q) **“GO Train Delay”** has the meaning given in Section 3.1(a).
- (r) **“GO Train Rerouting Event”** has the meaning given in Section 3.1(e).
- (s) **“GO Transit Timetable”** means the schedule of GO Transit trains as set out in Attachment 1 and Attachment 2 to Appendix C of Schedule 34 – Rail Corridor Access and Flagging.
- (t) **“Incident of Train Delay”** means an incident of delay that causes a Train Delay and may cause a subsequent related Train Delays.
- (u) **“Interim Completion LD Commencement Date”** has the meaning given in Section 4.2(a).
- (v) **“Major Track Closure”** has the meaning given in Schedule 34 – Rail Corridor Access and Safety.
- (w) **“Medium Construction Period Quality Failure”** means a Construction Period Quality Failure designated as “Medium” in the column entitled “Construction Period Failure Category” in the table set out in Appendix A.

- (x) “**Medium Qualifying NCR**” means a Qualifying NCR raised by Contracting Authority or Project Co on a Non-Conformance for all or any portion of Project Co Accepted Works. If a Qualifying NCR meets both definitions of,
- (i) Critical Qualifying NCR; and
 - (ii) this definition of Medium Qualifying NCR,
- then the Qualifying NCR shall be a Critical Qualifying NCR and not a Medium Qualifying NCR..
- (y) “**Medium Qualifying Process NCR**” means a Qualifying Process NCR raised by Contracting Authority or Project Co on a Non-Conformance that requires changes to a Works Submittal being used by Project Co in its delivery of the Works. If a Qualifying Process NCR meets both definitions of:
- (i) Critical Qualifying Process NCR; and
 - (ii) this definition of Medium Qualifying Process NCR,
- then the Qualifying Process NCR shall be a Critical Qualifying Process NCR and not a Medium Qualifying Process NCR.
- (z) “**Minor Construction Period Quality Failure**” means a Construction Period Quality Failure designated as “Minor” in the column entitled “Construction Period Failure Category” in the table set out in Appendix A.
- (aa) “**Minor Construction Period Quality Failure Tolerance**” has the meaning given in Section 5.3(a).
- (bb) “**Minor Qualifying NCR**” means a Qualifying NCR raised by Contracting Authority on a Non-Conformance on all or any portion of the Works that have been inspected and tested or approved by Project Co at a Witness and Hold Point, pursuant to the Inspection and Test Plan and relevant Inspection and Test Sub-Plan(s), but are not yet Project Co Accepted Works. For clarity, a Minor Qualifying NCR does not mean a Qualifying NCR raised by Project Co.
- (cc) “**Minor Qualifying Process NCR**” means a Qualifying Process NCR raised by Contracting Authority on a Non-Conformance that is not a Critical Qualifying Process NCR or Medium Qualifying Process NCR. For clarity, a Minor Qualifying Process NCR does not mean a Qualifying Process NCR raised by Project Co.
- (dd) “**NCR**” means a Non-Conformance Report.
- (ee) “**Project Co Accepted Works**” means all physical elements of the Works that have been accepted by Project Co as meeting its acceptance criteria for those Works pursuant to the Inspection and Test Plan.
- (ff) “**Qualifying NCR**” means a Non-Conformance Report in accordance with Schedule 11 – Quality Management regarding any Non-Conformance discovered in the physical elements of any of the Works:

- (i) for which Project Co has continued, or has stated the intention to continue, construction of the Works past the relevant Witness and Hold Point in contravention of the Inspection and Test Plan and relevant Inspection and Test Sub-Plan(s); or
- (ii) following Project Co’s stated completion of a task or component and Project Co’s statement that the requirements for the Design and Construction Certification Procedure have been met in respect of such Works and such Works have been inspected and tested by Project Co pursuant to the Inspection and Test Plan and relevant Inspection and Test Sub-Plan(s),

and shall include “Critical Qualifying NCR”, “Medium Qualifying NCR” or “Minor Qualifying NCR”.

- (gg) **“Qualifying Process NCR”** means a Non-Conformance Report in accordance with Schedule 11 – Quality Management regarding any Non-Conformance that is not a Qualifying NCR and shall include “Critical Qualifying Process NCR”, “Medium Qualifying Process NCR” or “Minor Qualifying Process NCR”.
- (hh) **“Rail Corridor Access Permit”** has the meaning given in Schedule 34 – Rail Corridor Access and Flagging.
- (ii) **“Rail Corridor Access Plan”** has the meaning given in Schedule 34 – Rail Corridor Access and Flagging.
- (jj) **“Remedial Period”** means the applicable remedial period set out in the column entitled “Remedial Period” in the table set out in Appendix A.
- (kk) **“Repeated Minor Construction Period Quality Failure”** has the meaning given in Section 5.3(c).
- (ll) **“Significant Incident of Train Delay”** means an Incident of Train Delay that causes one or more Train Delays that last for more than five minutes.
- (mm) **“Significant Train Delay Event”** has the meaning given in Section 6.2(b).
- (nn) **“Specified Costs”** means those costs and expenses incurred by Contracting Authority or Province Persons in relation to staffing, technical advisors and the Independent Certifier, in each case assuming normal utilization.
- (oo) **“Substantial Completion LD Commencement Date”** has the meaning given in Section 4.3(a).
- (pp) **“Total Construction Period Deduction”** has the meaning given in Section 5.1(a).
- (qq) **“Train Cancellation”** means any cancellation of a scheduled train as a result of an actual Train Delay or as a result of an anticipated Train Delay
- (rr) **“Train Delay”** means a CP Train Delay and/or a GO Train Delay, as the context requires.
- (ss) **“Train Delay Rectification Plan”** has the meaning given in Section 6.2(a).

2. LIQUIDATED DAMAGES – GENERAL

- (a) Except as expressly provided herein, nothing in this Schedule 21 shall restrict, limit, prejudice or in any other way impair the rights or remedies of the Parties under any other provision of this Project Agreement.
- (b) Project Co acknowledges and agrees that all liquidated damages set out in this Schedule 21 shall be payable whether or not Contracting Authority incurs or mitigates these damages, and that Contracting Authority shall have no obligation to mitigate these damages.
- (c) Project Co agrees that it is, and shall be, estopped from alleging that any liquidated damages set out in this Schedule 21 are a penalty and not liquidated damages, or are otherwise unenforceable for any reason, including that such damages were not incurred.
- (d) If liquidated damages are incurred by Project Co in accordance with this Schedule 21, Contracting Authority may, in its sole discretion and at any time, deduct the amount of those liquidated damages, as calculated and determined by Contracting Authority in accordance with this Schedule 21, from any amount due to Project Co by Contracting Authority.
- (e) The Parties agree that the liquidated damages set out in this Schedule 21 are not a penalty but represent a genuine and reasonable pre-estimate of,
 - (i) with respect to Sections 3.1(a) and 3.1(b) Specified Costs and the costs related to customer ticket refunds in circumstances where Project Co has caused an individual Train Delay;
 - (ii) with respect to Sections 3.1(c) and 3.1(d), Specified Costs and the costs related to customer ticket refunds in circumstances where Project Co has caused an individual Train Cancellation;
 - (iii) with respect to Section 3.1(e), Specified Costs for a GO Train Rerouting Event and the other costs associated with operating a bus bridge or other alternative transportation;
 - (iv) with respect to Section 3.2(a), Specified Costs for an individual Failure to Vacate;
 - (v) with respect to Section 3.2(b), Specified Costs for an individual Cancelled Major Track Closure;
 - (vi) with respect to Section 3.3, the liquidated damages that Metrolinx is obliged to pay to CP in respect of a CP Train Delay;
 - (vii) with respect to Section 4.1(a), Specified Costs arising from Project Co's failure to provide the applicable Key Individual Category A in accordance with Section 12.4(a) of the Project Agreement;
 - (viii) with respect to Section 4.1(b), Specified Costs arising from Project Co's failure to replace the applicable Key Individual Category A in accordance with Section 12.4(b) of the Project Agreement;

- (ix) with respect to Section 4.2, Specified Costs arising from Project Co failing to achieve the requirements for the Interim Completion Certificate and an Interim Completion Certificate not being issued on or before the Interim Completion LD Commencement Date;
- (x) with respect to Section 4.3, Specified Costs arising from Project Co failing to achieve the requirements for the Substantial Completion Certificate and a Substantial Completion Certificate not being issued on or before the Substantial Completion LD Commencement Date; and
- (xi) with respect to Section 5, a portion of the Specified Costs arising from Project Co failing to perform its obligations in accordance with the Project Agreement.

3. LIQUIDATED DAMAGES – TRAIN DELAYS AND TRACK CLOSURES

3.1 GO Train Delay

- (a) If Project Co, contrary to its obligations pursuant to the Project Agreement, causes a delay to a GO Transit in-service passenger train or a GO Transit train without passengers that is heading into service, from the then current GO Transit Timetable (each, a “**GO Train Delay**”), then Project Co shall pay to Contracting Authority liquidated damages in the following amounts:
 - (i) except as provided in Section 3.1(a)(ii), for the first GO Train Delay, caused by an Incident of Train Delay, that lasts for five minutes or more, \$[REDACTED] for each minute of that GO Train Delay (for clarity, including the first five minutes); plus
 - (ii) for the first GO Train Delay caused by an Incident of Train Delay, an additional \$[REDACTED] for each minute (to a total of \$[REDACTED] per minute) of that first GO Train Delay commencing at 15 minutes of delay; plus
 - (iii) a lump sum amount of \$[REDACTED] for each GO Train Delay to a GO Transit in-service passenger train or a GO Transit train without passengers that is heading into service that lasts 15 minutes or more.
- (b) For clarity, the liquidated damages for delay to a GO Transit train as set out in Section 3.1(a) shall not apply if Contracting Authority has agreed with Project Co, in advance and in writing, that such delay to the GO Transit train (measured against the then current GO Transit Timetable) shall not incur liquidated damages in accordance with this Section 3.1.
- (c) If, in the sole discretion of Contracting Authority, any actual GO Train Delay requires a Train Cancellation, Project Co shall be obliged to pay liquidated damages to Contracting Authority in accordance with Sections 3.1(a)(i), 3.1(a)(ii) and 3.1(a)(iii) , subject to the following:
 - (i) if the GO Train Delay that required the Train Cancellation lasted for less than 15 minutes, the GO Train Delay shall be deemed to be a GO Train Delay that lasted for 15 minutes; and
 - (ii) if the GO Train Delay that required the Train Cancellation lasted for 15 minutes or more, liquidated damages shall be assessed on the full period of the applicable GO Train Delay.

- (d) If a Train Cancellation occurs prior to an actual GO Train Delay because of an anticipated GO Train Delay, the anticipated GO Train Delay that required the Train Cancellation shall be deemed to be a GO Train Delay that lasts for 15 minutes.
- (e) If, in the sole discretion of Contracting Authority, Project Co causes a disruption on the Rail Corridor that prevents Contracting Authority from operating GO trains on the Rail Corridor, then Project Co shall be obliged to pay to Contracting Authority a lump sum amount of \$[REDACTED] to reroute GO trains to the wider track network, including the Bala Subdivision, so that such GO trains can complete their journey to/from Union Station (each such event being a “**GO Train Rerouting Event**”).
- (f) For the purpose of calculating the liquidated damages payable by Project Co in accordance with this Section 3.1, the timing (including commencement, duration and cessation) of any GO Train Delay and any Train Cancellation shall be determined based on the train schedule and train data that is established and maintained by the GO Transit Control Centre.

3.2 Major Track Closures

- (a) For a Major Track Closure, if Project Co fails to vacate and reinstate the track by the deadline and in the manner approved by Contracting Authority and set out in the Detailed Construction Activity Report for the Major Track Closure (each, a “**Failure to Vacate**”) Project Co shall pay to Contracting Authority liquidated damages as follows:
 - (i) \$[REDACTED] for each minute of the Failure to Vacate, until the Failure to Vacate triggers a Train Delay; plus
 - (ii) the liquidated damages for each Train Delay or Train Cancellation, if any, related to the Failure to Vacate payable pursuant to Section 3.1.
- (b) If Project Co causes the cancellation of any Major Track Closure (each, a “**Cancelled Major Track Closure**”) without providing Contracting Authority at least three weeks’ prior Notice of such cancellation, Project Co shall pay to Contracting Authority liquidated damages in the amount of \$[REDACTED].
- (c) If Project Co requires a greater number of Major Track Closures than is set out in Schedule 34 – Rail Corridor Access and Flagging in order to perform the Works (each, an “**Additional Major Track Closure**”), it shall submit a request for approval to Contracting Authority for each Additional Major Track Closure. Project Co shall pay to Contracting Authority \$[REDACTED] for each Additional Major Track Closure approved by Contracting Authority, which payment excludes any costs Project Co is obliged to pay in respect of any inspection and railway flagging related to the Additional Major Track Closure.

3.3 CP Train Delay

- (a) If Project Co contrary to its obligations pursuant to the Project Agreement, causes a delay to a CP train (each, a “**CP Train Delay**”) for less than two hours, then Project Co shall pay to Contracting Authority liquidated damages in the amount of,
 - (i) \$[REDACTED] per CP Train Delay; plus

- (ii) \$[REDACTED] for each 15 minute period or pro rata for each minute of such 15 minute period of CP Train Delay.
- (b) If Project Co, contrary to its obligations pursuant to the Project Agreement, causes a CP Train Delay for two hours or more, then Project Co shall pay to Contracting Authority liquidated damages in the amount of,
 - (i) \$[REDACTED] per hour, plus \$[REDACTED] for each 15 minute period or pro rata for each minute of such 15 minute period of CP Train Delay, for the first two hours of CP Train Delay and commencing at the beginning of the CP Train Delay; plus
 - (ii) \$[REDACTED] per hour or pro rata for each minute of such hour long period for any CP Train Delay exceeding two hours.

4. LIQUIDATED DAMAGES – KEY INDIVIDUALS, INTERIM COMPLETION AND SUBSTANTIAL COMPLETION

4.1 Key Individuals

- (a) If Project Co fails to comply with Section 12.4(a) of the Project Agreement, Project Co shall pay to Contracting Authority an amount equal to \$[REDACTED] for each Key Individual Category A to which the failure to comply applies, as liquidated damages.
- (b) In the event Project Co fails to nominate a competent, suitably qualified and experienced permanent replacement or replacements for a period of greater than 120 days from the date it became necessary for Project Co to replace any individual identified in Schedule 9 – Key Individuals, as set out in Section 12.4(b) of the Project Agreement, Project Co shall, commencing on the 121st day from the date it became necessary for Project Co to replace the individual, pay to Contracting Authority an amount equal to \$[REDACTED] per day for each Key Individual Category A which has not been permanently replaced, as liquidated damages.

4.2 Failure to Achieve Interim Completion

- (a) If Project Co has failed to achieve the requirements for the Interim Completion Certificate and an Interim Completion Certificate has not been issued on or before the date which is 30 days following the Scheduled Interim Completion Date (the “**Interim Completion LD Commencement Date**”) Project Co shall pay to Contracting Authority liquidated damages in the amount of \$[REDACTED] per Business Day, commencing on the Interim Completion LD Commencement Date and concluding on the earlier of:
 - (i) the Interim Completion Date; and
 - (ii) the date on which the termination of the Project Agreement takes effect in accordance with its terms.
- (b) If an event listed in Section 32.1(a) of the Project Agreement caused Project Co to be delayed, as of the time of the Scheduled Interim Completion Date, when delay is measured in accordance with Section 32.2 of the Project Agreement, and such delay resulted in Project Co failing to achieve the requirements for the issuance of the Interim Completion Certificate, the obligations of Project Co

to pay liquidated damages in accordance with Section 4.2(a) shall not apply for the number of Business Days of delay that are attributable to the applicable Section 32.1(a) event.

4.3 Failure to Achieve Substantial Completion

- (a) If Project Co has failed to achieve the requirements for the Substantial Completion Certificate and a Substantial Completion Certificate has not been issued on or before the date which is 30 days following the Scheduled Substantial Completion Date (the “**Substantial Completion LD Commencement Date**”) Project Co shall pay to Contracting Authority liquidated damages in the amount of \$[REDACTED] per Business Day, commencing on the Substantial Completion LD Commencement Date and concluding on the earlier of:
- (i) the Substantial Completion Date; and
 - (ii) the date on which the termination of the Project Agreement takes effect in accordance with its terms.
- (b) Subject and without prejudice to the other remedies of Contracting Authority in the Project Agreement (including remedies for termination for a Project Co Event of Default), payment in accordance with Sections 4.2(a) and 4.3(a) shall constitute full and final satisfaction of any and all damages for Specified Costs that may be claimed by Contracting Authority and Province Persons as a result of Project Co not achieving Substantial Completion by the Scheduled Substantial Completion Date.
- (c) Notwithstanding Sections 4.2(a) and 4.3(a), Project Co’s obligation to indemnify Contracting Authority pursuant to Section 46.1(a)(i) of the Project Agreement shall remain unaffected by, and shall apply in addition to, any liquidated damages payable by Project Co pursuant to Sections 4.2(a) and 4.3(a), provided, however, that any amount for which Project Co is required to indemnify Contracting Authority pursuant to Section 46.1(a)(i) of the Project Agreement shall exclude Specified Costs and expenses in respect of which liquidated damages have been paid or are payable.

5. CONSTRUCTION ENFORCEMENT REGIME

5.1 Construction Period Deductions

- (a) If, at any time prior to Substantial Completion, Project Co commits one or more Construction Period Quality Failures, Contracting Authority may, in its sole discretion, deduct corresponding Construction Period Deductions from the Substantial Completion Payment. The cumulative amount of all Construction Period Deductions (the “**Total Construction Period Deduction**”) shall be applied against and shall decrease the Substantial Completion Payment.

5.2 Calculation of the Total Construction Period Deduction and the Construction Period Deductions

- (a) The Total Construction Period Deduction shall be calculated in accordance with the following formula:

$$TCPD = \sum CPD_n$$

Where:

TCPD means the Total Construction Period Deduction from Financial Close to Substantial Completion; and

$\sum CPD_n$ means the sum of Construction Period Deductions from Financial Close to Substantial Completion in relation to Construction Period Quality Failures calculated in accordance with this Schedule 21 (the “**Construction Period Quality Failure Deduction**”).

- (b) The Construction Period Deduction attributable to each Construction Period Quality Failure shall be as follows:
- (i) in the case of a Minor Construction Period Quality Failure for a Non-Conformance identified by Project Co, including for a Non-Conformance Report initiated by Project Co, there shall be no Construction Period Deduction;
 - (ii) in the case of a Medium Construction Period Quality Failure for a Non-Conformance identified by Project Co, including for a Non-Conformance Report initiated by Project Co, each Construction Period Deduction shall equal \$[REDACTED];
 - (iii) subject to Section 5.3, in the case of a Minor Construction Period Quality Failure for a Non-Conformance identified by Contracting Authority, including for a Non-Conformance Report initiated by Contracting Authority:
 - (A) the first Construction Period Deduction shall equal \$[REDACTED]; and
 - (B) each subsequent Construction Period Deduction arising from a failure to remediate prior to the expiration of the applicable Remedial Period, shall be 120 per cent of the immediately previous Construction Period Deduction but shall not exceed [REDACTED] per cent of the applicable first Construction Period Deduction;
 - (iv) in the case of a Medium Construction Period Quality Failure identified by Contracting Authority, including for a Non-Conformance Report initiated by Contracting Authority:
 - (A) the first Construction Period Deduction shall equal \$[REDACTED]; and
 - (B) each subsequent Construction Period Deduction arising from a failure to remediate prior to the expiration of the applicable Remedial Period shall equal [REDACTED] per cent of the immediately previous Construction Period Deduction but shall not exceed [REDACTED] per cent of the applicable first Construction Period Deduction; and
 - (v) in the case of a Critical Construction Period Quality Failure:
 - (A) the first Construction Period Deduction shall equal \$[REDACTED]; and

- (B) each subsequent Construction Period Deduction arising from a failure to remediate prior to the expiration of the applicable Remedial Period shall equal [REDACTED] per cent of the immediately previous Construction Period Deduction but shall not exceed [REDACTED] per cent of the applicable first Construction Period Deduction.
- (c) For clarity the occurrence of a Construction Period Quality Failure will immediately give rise to a right, on behalf of Contracting Authority, to apply the Construction Period Deductions against the Substantial Completion Payment, irrespective of the Remedial Period permitted.
- (d) After the occurrence of a Construction Period Quality Failure, Project Co shall remediate the Construction Period Quality Failure prior to the expiration of the applicable Remedial Period set out in Appendix A. If, prior to the expiration of the applicable Remedial Period, Project Co demonstrates, to the satisfaction of the Contracting Authority Representative, acting reasonably, that it has remedied the Construction Period Quality Failure, no further Construction Period Deduction shall be made in respect of that Construction Period Quality Failure. If Project Co fails to remediate a Construction Period Quality Failure prior to the expiration of the applicable Remedial Period, Contracting Authority, may, in its sole discretion, apply a further Construction Period Deduction, calculated in accordance with this Section 5.2, and a further Remedial Period (or Remedial Periods) of the same duration shall be deemed to have commenced. Contracting Authority may, in its sole discretion, apply the applicable Construction Period Deduction each time Project Co fails to remediate a Construction Period Quality Failure prior to the expiration of the applicable Remedial Period until such time as Project Co demonstrates, to the satisfaction of the Contracting Authority Representative, acting reasonably, that it has remediated the applicable Construction Period Quality Failure.

5.3 Tolerances for Minor Construction Period Quality Failures for Non-Conformance Reports Initiated by Contracting Authority

- (a) Contracting Authority shall assess Construction Period Quality Failures on a month to month basis. Except as provided in Section 5.3(c), Contracting Authority shall not apply a Construction Period Deduction due to a Minor Construction Period Quality Failure for a Non-Conformance Report initiated by Contracting Authority in respect of any month in which the total number of Minor Construction Period Quality Failures for Non-Conformance Reports initiated by Contracting Authority for that month is less than or equal to 10 (the “**Minor Construction Period Quality Failure Tolerance**”).
- (b) If the Minor Construction Period Quality Failure Tolerance is exceeded, Contracting Authority may, in its sole discretion, apply a Construction Period Deduction for each Minor Construction Period Quality Failure for a Non-Conformance Report initiated by Contracting Authority in excess of the Minor Construction Period Quality Failure Tolerance during the applicable month.
- (c) If, in any month, a Minor Construction Period Quality Failure for a Non-Conformance Report initiated by Contracting Authority is due to circumstances that are substantively the same cause as a previous Minor Construction Period Quality Failure for a Non-Conformance Report initiated by Contracting Authority (within the same month or in a different month) (a “**Repeated Minor Construction Period Quality Failure**”), then a Construction Period Deduction shall be made in respect of the third and each subsequent Repeated Minor Construction Period Quality Failure, irrespective of the Minor Construction Period Quality Failure Tolerance.

5.4 Administration of Construction Period Quality Failures and Construction Period Deductions

- (a) Subject to Sections 5.4(b) to 5.4(e) inclusive, Contracting Authority shall use the Monthly Non-Conformance Report produced by Project Co for the purposes of calculating the relevant Construction Period Deductions.
- (b) If either Party believes that there is an error or omission in a Monthly Non-Conformance Report, that Party shall promptly provide Notice to the other Party of such error or omission. Immediately after a Notice given pursuant to this Section 5.4(b), Project Co and Contracting Authority shall attempt to resolve or clarify the error or omission and amend the applicable Monthly Non-Conformance Report, to their mutual satisfaction, acting reasonably. Subject to Section 5.4(e), if the Parties fail to resolve or clarify the error or omission within 10 Business Days after a Notice given pursuant to this Section 5.4(b), either Party may refer the matter to the Dispute Resolution Procedure. Subject to Section 5.4(d) and Section 5.4(e), the Parties are prohibited from giving Notice of an error or omission in the applicable Monthly Non-Conformance report pursuant to this Section 5.4(b) after the expiration of 60 days after the date of the applicable Monthly Non-Conformance Report.
- (c) Subject to Section 5.4(e), if Project Co fails to monitor or accurately report a Construction Period Event or Construction Period Quality Failure then, in addition to the Construction Period Deduction to be made in respect of the relevant Construction Period Quality Failure (if any), a failure to monitor or report a Construction Period Event or a Construction Period Quality Failure shall be deemed to be a Minor Construction Period Quality Failure.
- (d) In the event that Contracting Authority or Project Co discovers new errors, omissions or failures of the type referred to in Section 5.4(b) or Section 5.4(c), such errors, omissions or failures shall be dealt with in accordance with Section 5.4(b) or Section 5.4(c), as applicable, and, for clarity, Contracting Authority may, in its sole discretion, apply Construction Period Deductions in respect of any Construction Period Quality Failures discovered pursuant to this Section 5.4(d) in the manner set out in Section 5.2. Any such Construction Period Deductions shall be made from the Substantial Completion Payment. For clarity, the 60 day deadline set out in Section 5.4(b) shall not apply to errors, omissions or failures revealed pursuant to this Section 5.4(d).
- (e) For the purposes of Sections 5.4(b), 5.4(c) and 5.4(d), if Project Co or a Project Co Party has engaged in any fraudulent action or inaction, deliberate misrepresentation, or gross misconduct or incompetence,
- (i) in the preparation of the Monthly Non-Conformance Report; or
 - (ii) in carrying out the Work resulting in Construction Period Quality Failures,
- then,
- (iii) the 60 day deadline set out in Section 5.4(b) shall not apply; and
 - (iv) a failure to monitor or accurately report a Construction Period Event or Construction Period Quality Failure pursuant to Section 5.4(c) shall be deemed to be a Critical Construction Period Quality Failure.

5.5 Additional Requirements for Tracking and Reporting

- (a) In addition to the requirements of Section 7.2 of Schedule 11 – Quality Management, the Non-Conformance Tracking System shall record Construction Period Deductions pursuant to this Schedule 21.
- (b) In addition to the requirements of Section 7.2 of Schedule 11 – Quality Management, the Monthly Non-Conformance Report shall contain:
 - (i) the number of Construction Period Deductions in each Construction Period Failure Category accrued within the last month pursuant to this Schedule 21; and
 - (ii) summary statistics and historic trends since Financial Close for the number of Construction Period Deductions in each Construction Period Failure Category each month pursuant to this Schedule 21.
- (c) Project Co shall track and set out the Total Construction Period Deduction in each monthly Works Report (both on a month by month basis and as a running total). Project Co shall report on the final Total Construction Period Deduction in the Substantial Completion Notice. If Contracting Authority disagrees with the Total Construction Period Deduction set out by Project Co in any Works Report or in the Substantial Completion Notice, then Contracting Authority shall notify Project Co and the Independent Certifier of such disagreement. In the event of a disagreement between the Parties over the Total Construction Period Deduction set out in the Substantial Completion Notice, the Parties shall seek to agree to any matter(s) in dispute with respect to the Total Construction Period Deduction. If the matter(s) cannot be resolved within 15 Business Days after Contracting Authority’s notification of disagreement (or such other period as may be otherwise agreed by the Parties), then such matter shall be dealt with in accordance with Schedule 27 – Dispute Resolution Procedure. For clarity, notwithstanding any disagreement between the Parties with respect to the quantum of the Total Construction Period Deduction, the Total Construction Period Deduction as calculated and determined by Contracting Authority in accordance with this Section 5 shall be applied against and shall decrease the Substantial Completion Payment.

5.6 Disputing a Non-Conformance Report During the Works

- (a) In respect of the following circumstances, the Parties shall be subject to the binding determination of the Independent Certifier pursuant to Section 4.3 and 4.4 of Schedule 27 – Dispute Resolution Procedure and the Independent Certifier’s decision shall be final and shall not be subject to resolution pursuant to Schedule 27 – Dispute Resolution Procedure:
 - (i) a Notice of objection to a Non-Conformance Report has not been resolved by mutual agreement between Contracting Authority and Project Co within five Business Days after the delivery of a Notice of the objection pursuant to Section 7.1(c) and Section 7.1(e) of Schedule 11 – Quality Management; and
 - (ii) the Non-Conformance Report referred to in Section 5.6(a)(i) would have been a Construction Period Quality Failure with a Construction Period Failure Category of “Minor” if the Notice of objection referred to in Section 5.6(a)(i) had not been issued.

5.7 Relief from Construction Period Deductions

- (a) Subject to Project Co meeting the obligations set out in Section 32.2 and Section 32.3 of the Project Agreement, if a Construction Period Quality Failure:
- (i) has been assessed in accordance with this Schedule 21; and
 - (ii) has arisen from a Non-Conformance that has been directly caused by one or more of the events set out in Section 32.1(a) of the Project Agreement, whether or not such event constitutes a Delay Event,

such Construction Period Quality Failure shall not be applied as part of the Construction Period Deduction in accordance with this Section 5.

6. MAXIMUM LIABILITY AND WITHDRAWAL OF RAIL CORRIDOR ACCESS PRIVILEGES

6.1 Maximum Liability for Liquidated Damages and Construction Enforcement Regime

- (a) The liquidated damages payable by Project Co in accordance with Sections 3.1(a), 3.1(c), 3.1(d), 3.1(e) and 3.3 shall be limited to \$[REDACTED] on an aggregate basis.
- (b) The liquidated damages payable by Project Co,
- (i) in accordance with Sections 3.2, 4.1, 4.2 and 4.3; plus
 - (ii) the Total Construction Period Deduction calculated in accordance with Section 5,
- shall be limited to \$[REDACTED], on an aggregate basis.
- (c) If Project Co has incurred an obligation to pay [REDACTED] per cent of the liquidated damages aggregate cap set out in Section 6.1(a), and CP and/or Metrolinx incur further damages as a result of a CP Train Delay, then, without prejudice to any other rights of Contracting Authority under the Project Agreement, Contracting Authority shall be entitled to claim for such damages pursuant to Project Co's indemnity to Contracting Authority, in accordance with Sections 46.1(a)(v) and 47.1(c) of the Project Agreement.

6.2 Withdrawal of Rail Corridor Access Privileges

- (a) If, on any day, Project Co causes more than one Significant Incident of Train Delay, it shall, no later than five Business Days after the day on which that Significant Incident of Train Delay occurred, provide a detailed explanation to Contracting Authority as to the cause of each applicable Significant Incident of Train Delay and a rectification plan designed to eliminate future Train Delays (each a "**Train Delay Rectification Plan**"), for review and approval by Contracting Authority, in its sole discretion.
- (b) If Project Co,
- (i) causes more than three Significant Incidents of Train Delay in a calendar quarter; or

- (ii) has incurred an obligation to pay [REDACTED] per cent or more of the liquidated damages aggregate cap set out in Section 6.1(a),

(each a “**Significant Train Delay Event**”), Project Co shall immediately lose its rights to access the Rail Corridor, subject to demobilization and any directions issued by Contracting Authority with respect to vacating the Rail Corridor. Project Co shall, no later than five Business Days after the Significant Train Delay Event occurs, provide to Contracting Authority both a Train Delay Rectification Plan and a revised Rail Corridor Access Plan, each, in accordance with all requirements set out in Schedule 34 – Rail Corridor Access and Flagging, setting out a rectification plan designed to eliminate future Train Delays, for review and approval by Contracting Authority. Project Co’s right to access the Rail Corridor shall not be re-instated until Contracting Authority has reviewed and approved, in its sole discretion, the Train Delay Rectification Plan and the revised Rail Corridor Access Plan, which approval may contain conditions imposed on Project Co and intended to eliminate Train Delays.

- (c) Contracting Authority shall review the Train Delay Rectification Plan and the revised Rail Corridor Access Plan submitted in accordance with Section 6.2(b) and provide its comments no later than 10 Business Days after the date of Project Co’s submission.

**APPENDIX A
CONSTRUCTION PERIOD PERFORMANCE CRITERIA**

Non-Conformances Discovered in Physical Elements of the Works

[REDACTED]

SCHEDULE 22

VARIATION PROCEDURE

1. VARIATIONS

1.1 Definitions

- (a) In this Schedule 22 – Variation Procedure, unless the context indicates a contrary intention, terms which are defined in the Project Agreement (and not otherwise defined in this Schedule 22 – Variation Procedure) shall have meanings given to them in the Project Agreement and the following terms shall have the following meanings:
- (i) “**Direct Cost**” has the meaning given in Appendix A of this Schedule 22.
 - (ii) “**Estimate**” has the meaning given in Section 1.4(a).
 - (iii) “**Overhead and Profit**” has the meaning given in Appendix B of this Schedule 22.
 - (iv) “**Project Co Variation Notice**” has the meaning given in Section 2.1(a).
 - (v) “**Variation**” means a variation, addition, reduction, substitution, omission, modification, deletion, removal or other change to the whole or any part of the Works.
 - (vi) “**Variation Confirmation**” has the meaning given in Section 1.7(a)(ii).
 - (vii) “**Variation Directive**” means a written instruction which is issued on a form designated as a “Variation Directive Form” and signed by the Contracting Authority Representative directing Project Co to immediately proceed with a Variation pending the finalization and issuance of a Variation Confirmation for that Variation.
 - (viii) “**Variation Enquiry**” has the meaning given in Section 1.3(a).

1.2 General

- (a) Contracting Authority has the right from time to time to propose and require Project Co to carry out and implement a Variation, and any such Variation shall be subject to the provisions of this Schedule 22, provided that Contracting Authority shall not be permitted to withdraw a Variation Enquiry (nor will a Variation Enquiry be deemed to have been withdrawn) with respect to those circumstances specified in the Project Agreement for which Contracting Authority is obligated to proceed with a Variation.
- (b) Contracting Authority shall be obligated to proceed with a Variation in certain circumstances specified in the Project Agreement, and any such Variation shall be subject to the provisions of this Schedule 22.
- (c) The only payment or compensation payable by Contracting Authority to Project Co in connection with any Variation shall be the sum of the following amounts:
- (i) the Direct Cost of such Variation; plus

- (ii) Overhead and Profit.
- (d) Project Co will not be entitled to any payment, compensation or extension of time for a Variation except to the extent provided in a Variation Confirmation or Variation Directive in accordance with this Schedule 22.
- (e) Project Co shall attend and shall cause any relevant Subcontractors to attend any meetings requested by Contracting Authority from time to time to discuss the implementation of any Variation or Variations generally, including with respect to the administration and pricing of Variations.

1.3 Variation Enquiry

- (a) If Contracting Authority proposes or is obligated pursuant to the terms of the Project Agreement or Applicable Law to initiate a Variation it shall deliver to Project Co a written Notice of the proposed Variation (a “**Variation Enquiry**”).
- (b) A Variation Enquiry shall:
 - (i) describe the proposed Variation with sufficient detail to enable Project Co to prepare a detailed Estimate;
 - (ii) in the event that the proposed Variation will require a Capital Expenditure, state whether Contracting Authority intends to pay for the Variation by way of lump sum payment or payments, adjustment to the Guaranteed Price (and, if applicable, with a request for Project Co to obtain financing for all or part of the Variation), or a combination thereof; and
 - (iii) provide a preliminary indication of any provisions of the Project Agreement (including the Output Specifications or the Project Co Proposal Extracts) that will be affected by the proposed Variation, as well as the amendments to the Project Agreement (including the Output Specifications or the Project Co Proposal Extracts) that may be necessary to accommodate the Variation.

1.4 Delivery of Estimate

- (a) As soon as practicable and in any event within 15 Business Days after receipt of a Variation Enquiry, or such longer period as the Parties agree acting reasonably, Project Co shall deliver its detailed breakdown, estimate and other information (an “**Estimate**”) prepared in accordance with and meeting the requirements of Section 1.6 and in the form prescribed by Contracting Authority, acting reasonably.

1.5 Project Co Grounds for Objection

- (a) Project Co may only refuse to deliver an Estimate if Project Co can demonstrate to Contracting Authority’s satisfaction, acting reasonably, within the period for delivery of an Estimate specified or agreed pursuant to Section 1.4(a), that:
 - (i) the implementation of the Variation would materially and adversely affect the health and safety of any person;

- (ii) the implementation of the Variation would:
 - (A) infringe Applicable Law;
 - (B) cause to be revoked any of the existing Permits, Licences, Approvals and Agreements required by Project Co to perform the Works, and any of such Permits, Licences, Approvals and Agreements is not, using commercially reasonable efforts, capable of amendment or renewal; or
 - (C) require any new Permits, Licences, Approvals and Agreements for Project Co to perform the Works, any of which will not, using commercially reasonable efforts by Project Co or Contracting Authority, as applicable, be obtainable;
 - (iii) the proposed Variation would have a material and adverse effect on performance of the Works (except those Works which have been specified as requiring amendment in the Variation Enquiry) in a manner not compensated pursuant to this Schedule 22;
 - (iv) the implementation of the Variation would be a departure from Good Industry Practice;
 - (v) Contracting Authority does not have the legal power or capacity to require the Variation to be implemented or to do anything envisaged by this Schedule 22 in respect of or in connection with the Variation;
 - (vi) the Variation would, if implemented, result in a change in the essential nature of the New Metrolinx Infrastructure and the New Third Party Infrastructure;
 - (vii) the Variation Enquiry does not comply with the requirements of Section 1.3 (including a failure to include adequate information therein to enable Project Co to prepare an Estimate in respect thereof); or
 - (viii) in the case of a Variation relating to the Works, the time specified for commencement and/or completion of such Variation cannot be achieved by Project Co despite commercially reasonable efforts.
- (b) If Project Co refuses to provide an Estimate on the grounds set out in Section 1.5(a), Project Co shall, within the period for delivery of an Estimate specified or agreed pursuant to Section 1.4(a), deliver to Contracting Authority a written Notice specifying the grounds upon which Project Co rejects the Variation and the details thereof.

1.6 Estimate Requirements

- (a) Unless Contracting Authority in a Variation Enquiry requires only specified limited information, each Estimate shall include the following information, sufficient to demonstrate to Contracting Authority's reasonable satisfaction:
 - (i) the steps Project Co will take to implement the Variation, in such detail as is reasonable and appropriate in the circumstances, including a schedule, work breakdown structure, contact list, description of roles and responsibilities and an organizational structure chart;

- (ii) any impact on any Scheduled Interim Completion Date or the Scheduled Substantial Completion Date, and any other schedule impact on the provision of the Works or the remainder of the New Metrolinx Infrastructure and the New Third Party Infrastructure and the completion of the Works (including for certainty, any impact of the proposed Variation after taking into consideration other Variations);
- (iii) any impact on the performance of the Works and any other impact on the Project Agreement (including for certainty, any impact of the proposed Variation after taking into consideration other Variations);
- (iv) any amendments to the Project Agreement or any Project Document required as a consequence of the Variation, the objective of such amendments being to ensure that (save for the obligation of Contracting Authority to make payments or altered payments in respect of the Variation) the Parties are in no better and no worse position in relation to the Project than they would have been in if the Variation had not been implemented and, in particular, that there will be no material adverse change to the risk profile of the Project as a result of the Variation;
- (v) any impact on the Direct Cost to Project Co and each Subcontractor of the proposed Variation, including:
 - (A) any Capital Expenditure that will be incurred, reduced or avoided and the impact on Project Co's cash flows from incurring, reducing or avoiding such costs (whether financed by Project Co or Contracting Authority); and
 - (B) any other costs that will be incurred, reduced or avoided and the impact on Project Co's cash flows from incurring, reducing or avoiding such costs;
- (vi) either, subject to Section 1.9:
 - (A) a confirmation that the proposed Variation will not affect Project Co's existing financing or that Project Co's existing financing is adequate to implement the Variation; or
 - (B) if new or additional financing is required to implement the Variation, an indication as to the availability of such new or additional financing and the cost and terms of such new or additional financing;
- (vii) Project Co's preliminary indication of the potential increase or decrease, if any, to the Guaranteed Price;
- (viii) any Permits, Licences, Approvals and Agreements that must be obtained or amended for the Variation to be implemented, and the latest date by which Project Co must receive a Variation Confirmation and Project Co or Contracting Authority, as applicable, must obtain or amend such Permits, Licences, Approvals and Agreements for the Estimate to remain valid; and
- (ix) the proposed methods of certification of any construction or operational aspect of the Works required by the Variation if not covered by the provisions of the Project Agreement,

- in each case, together with such supporting information and justification as is reasonably required.
- (b) In preparing its Estimate, Project Co shall include sufficient information to demonstrate to Contracting Authority's satisfaction, acting reasonably, that:
- (i) subject to Sections 1.6(c) and 1.6(e), Project Co has used or has obliged each Subcontractor (or will oblige any Subcontractor not yet selected) to use commercially reasonable efforts, including the use of competitive quotes or tenders, to minimize any increase in costs and to maximize any reduction in costs;
 - (ii) except as otherwise set out in this Schedule 22, all costs of Project Co and each Subcontractor are limited to the Direct Cost of the proposed Variation described in Appendix A of this Schedule 22;
 - (iii) Overhead and Profit has been calculated in accordance with Appendix B of this Schedule 22;
 - (iv) all costs of providing Works, including Capital Expenditures, reflect:
 - (A) labour and material rates applying in the open market to providers of services similar to those required by the Variation;
 - (B) any and all changes in the Output Specifications arising out of the proposed Variation; and
 - (C) any and all changes in risk allocation;
 - (v) the full amount of any and all expenditures that have been reduced or avoided (including any Capital Expenditure) and that all such expenditures, including all applicable amounts for overhead and profit anticipated to be incurred but for the Variation, have been taken into account and applied in total to reduce the amount of all costs; and
 - (vi) Project Co has mitigated or will mitigate the impact of the Variation, including on the Project Works Schedules, the performance of the Works, the expected usage of utilities, and the Direct Cost of the proposed Variation to be incurred.
- (c) Project Co shall use commercially reasonable efforts to obtain the best value for money when procuring and/or delivering any work, services, supplies, materials or equipment required by the Variation, including, at the request of Contracting Authority, applying, using and comparing applicable industry benchmarks or benchmarking data for such purposes, and will comply with all Good Industry Practice in relation to any such procurement, to a standard no less than Project Co would apply if all costs incurred were to its own account without recourse to Contracting Authority, including using commercially reasonable efforts to mitigate such costs. Also, to the extent the procurement or delivery of any work, services, supplies, materials or equipment required by the Variation results in costs or expenses that are in excess of those costs or expenses established by industry benchmarks or benchmarking data, Project Co shall provide Contracting Authority sufficient information and analysis to demonstrate to Contracting Authority's satisfaction, acting reasonably, that such excess costs or expenses are reasonable and justified in the context of the subject Variation.

- (d) As soon as practicable, and in any event not more than 15 Business Days after Contracting Authority receives an Estimate, Project Co and Contracting Authority shall discuss and seek to agree on the Estimate, including any amendments to the Estimate agreed to by the Parties.
- (e) At the request of Contracting Authority, including if Contracting Authority is required by Applicable Law or any policy applicable to Contracting Authority, to competitively tender any contract in relation to the proposed Variation, Project Co shall seek and evaluate competitive tenders for the proposed Variation, including in accordance with such Applicable Law or policy.
- (f) Contracting Authority may modify a Variation Enquiry in writing at any time for any matter relating to the Estimate or the discussions in relation thereto, in which case Project Co shall, as soon as practicable and in any event not more than 10 Business Days after receipt of such modification, notify Contracting Authority in writing of any consequential changes to the Estimate.
- (g) If the Parties cannot agree on an Estimate pursuant to Section 1.6(d), then any Dispute will be determined in accordance with Schedule 27 - Dispute Resolution Procedure.

1.7 Variation Confirmation

- (a) As soon as practicable, and in any event within 15 Business Days after the later of the date the Estimate was delivered and the date the Estimate was either agreed to or any Dispute in respect thereof was determined in accordance with Schedule 27 - Dispute Resolution Procedure, Contracting Authority shall either:
 - (i) subject to Section 1.2(b) and Section 1.7(g), withdraw the Variation Enquiry by written Notice to Project Co; or
 - (ii) issue a written confirmation of the Estimate signed by Contracting Authority (the “Variation Confirmation”), including any agreed modifications thereto or any modifications resulting for the determination of a Dispute in respect thereof, which Variation Confirmation may be subject to Project Co obtaining financing pursuant to Section 1.8.
- (b) Within five Business Days following Project Co’s receipt of a Variation Confirmation issued pursuant to Section 1.7(a)(ii), Project Co shall execute and deliver a copy of such executed Variation Confirmation to Contracting Authority.
- (c) If Contracting Authority does not issue a Variation Confirmation within such 15 Business Days, then, subject to Section 1.2(b) and Section 1.7(f), the Variation Enquiry shall be deemed to have been withdrawn.
- (d) Upon the Variation Confirmation being issued, and if applicable upon Project Co obtaining financing pursuant to Section 1.8:
 - (i) the Parties shall as soon as practicable thereafter do all acts and execute all documents to amend the Project Agreement necessary to implement the Variation, including in respect of any required extension of time and including provision for payment to Project Co as provided in Section 1.10;

- (ii) Project Co shall implement the Variation as provided for in the Variation Confirmation, and subject to amendments pursuant to Section 1.7(d)(i) all provisions of the Project Agreement applicable to the Works shall apply to the Works as thereby changed and no additional claim with respect to the Variation or Variation Confirmation will be considered; and
 - (iii) payment in relation to the Variation shall be as provided for in Section 1.10 and pursuant to any amendments pursuant to Section 1.7(d)(i).
- (e) If a Variation Confirmation is subject to Project Co obtaining financing pursuant to Section 1.8, then the Variation Confirmation shall not be effective until:
- (i) Project Co obtains such financing acceptable to Contracting Authority in its sole discretion; or
 - (ii) Contracting Authority in its sole discretion waives such requirement.
- (f) Except as hereinafter provided, until a Variation Confirmation has been issued:
- (i) the determination of whether or not to proceed with a Variation shall at all times be at Contracting Authority's sole discretion, despite any Dispute or any other matter in relation to a Variation being referred to or determined in accordance with Schedule 27 - Dispute Resolution Procedure; and
 - (ii) Contracting Authority may at any time withdraw a Variation Enquiry and, subject to Section 1.7(g), Contracting Authority shall not be obligated to Project Co in respect of a Variation until such time as Contracting Authority in its sole discretion issues a Variation Confirmation and, if applicable, Project Co has obtained the financing requested by Contracting Authority or Contracting Authority has waived such requirement, provided that Contracting Authority may not withdraw a Variation Enquiry in circumstances where Contracting Authority is obligated pursuant to the terms of the Project Agreement to proceed with a Variation. In such circumstances Schedule 27 – Dispute Resolution Procedure shall be employed to finalize any aspects of the Variation which cannot otherwise be agreed to in accordance with the terms of this Schedule 22.
- (g) If a Variation Confirmation is not issued for any Variation Enquiry in respect of which Project Co has used commercially reasonable efforts to produce a fair and accurate Estimate, Contracting Authority shall reimburse Project Co for the Direct Cost reasonably and properly incurred by Project Co in connection with preparing the Estimate.

1.8 Financing

- (a) Subject to Section 1.9, if Project Co in its Estimate confirms that existing financing is not available to pay for the proposed Variation and if Contracting Authority requests Project Co to obtain financing for a Variation, then a Variation Confirmation may be issued subject to Project Co obtaining financing. In such event, Project Co shall use commercially reasonable efforts to obtain the requested financing on terms satisfactory to Project Co and Contracting Authority, provided that, Project Co shall not be required to seek debt financing from any source other than the existing Lenders.

- (b) If Project Co has used commercially reasonable efforts to obtain the requested financing but has been unable to obtain an offer of financing on terms reasonably satisfactory to Project Co and Contracting Authority within 60 days following the date that Contracting Authority issues the Variation Confirmation, then Project Co shall have no further obligation to obtain financing for the Variation and any Variation Confirmation subject to financing shall no longer have any effect unless Contracting Authority, in its sole discretion, waives the requirement for financing or unless Contracting Authority is obligated to proceed with the Variation pursuant to the terms of the Project Agreement.
- (c) Subject to Section 1.9, if Project Co obtains an offer of financing on terms reasonably satisfactory to Project Co, Project Co shall provide Contracting Authority with details of such financing, and Contracting Authority shall, in its sole discretion, determine whether Project Co should proceed with such financing. If Contracting Authority determines that Project Co should not proceed with such financing, then Project Co shall have no further obligation to obtain financing for the Variation and any Variation Confirmation subject to financing shall no longer have any effect unless Contracting Authority, in its sole discretion, waives the requirement for financing or unless Contracting Authority is obligated to proceed with the Variation pursuant to the terms of the Project Agreement.
- (d) Subject to Section 1.9, Contracting Authority may at any time withdraw the requirement for Project Co to use commercially reasonable efforts to obtain financing, after which Project Co shall have no further obligation to obtain financing for the Variation and any Variation Confirmation subject to financing shall no longer have any effect unless Contracting Authority in its sole discretion waives the requirement for financing or unless Contracting Authority is obligated to proceed with the Variation pursuant to the terms of the Project Agreement.
- (e) If Contracting Authority waives the requirement for financing or if Project Co has no further obligation to obtain financing for the Variation pursuant to Sections 1.8(b), 1.8(c) or 1.8(d), then Project Co shall proceed with the Variation as set out in the Variation Confirmation and Contracting Authority shall pay for the Variation as provided for in Section 1.10(a)(ii).

1.9 Increase or Decrease in the Cost of the Financing

- (a) If there is an increase or a decrease in the Cost of the Financing as a result of a Variation, the Guaranteed Price shall be increased or decreased by the increase or decrease to the Cost of the Financing. Project Co shall provide the calculation of the increase or decrease in the Cost of the Financing, together with a certificate of the Lenders' Agent verifying such calculation. Where the increase in the Cost of the Financing includes breakage costs, but the impact of the Variation on the Cost of the Financing could also be accommodated without incurring breakage costs, calculations for both options shall be provided to Contracting Authority, together with a certificate of the Lenders' Agent addressed to Project Co (which will expressly provide that the certificate may be relied upon by Contracting Authority) verifying such calculations. Contracting Authority shall, in its sole discretion, within five Business Days after receiving such certificate from the Lenders' Agent, select its preferred option by providing written Notice to Project Co and the Lenders' Agent. For greater certainty, the increases or decreases in the Cost of the Financing shall be calculated in a commercially reasonable manner and in accordance with the Lending Agreements, and without regard to the identity of the party paying such costs and expenses and, with respect to any swap breakage costs or gains, such costs or gains shall be calculated in accordance with standard market practices.

- (b) If a Variation gives rise to a net benefit to Project Co through a reduction of the Cost of the Financing, then Project Co shall pay any net benefit received by Project Co to Contracting Authority.

1.10 Payment

- (a) If a Variation Confirmation has been issued and is not subject to financing, or if the requirement for financing has been satisfied by Project Co or has been waived by Contracting Authority, a price adjustment for the Variation, as set out in the Estimate and as adjusted and confirmed by the Variation Confirmation, shall be made as follows:
- (i) the Guaranteed Price shall be adjusted as set out in the Variation Confirmation; or
 - (ii) payment for Capital Expenditures as set out in the Variation Confirmation and not financed by Project Co shall be paid as follows:
 - (A) Contracting Authority shall pay such Capital Expenditures in lump sum payments based on a payment schedule agreed by Contracting Authority and Project Co, acting reasonably, to reflect the amount and timing of the Capital Expenditures to be incurred by Project Co in carrying out the Variation to the extent borne by Contracting Authority; and
 - (B) where payment for part of the Variation reflects the carrying out of, or specific progress towards, an element within the Variation, Project Co shall provide satisfactory evidence confirming that the part of the Variation corresponding to each occasion when payment is due under the payment schedule has been duly carried out.

In the event Contracting Authority and Project Co fail to agree as to the terms of the payment schedule, the payment schedule shall be determined in accordance with Schedule 27 – Dispute Resolution Procedure, provided that, where all or any part of the Variation is being carried out by a third party under a contract with Project Co, subject to the terms of any contract between Project Co and that third party in relation to the implementation of the Variation having been approved by Contracting Authority, the process under Schedule 27 – Dispute Resolution Procedure shall determine a payment schedule which would enable Project Co to be funded by Contracting Authority in time to make payments to that third party in accordance with its contract with Project Co.

For greater certainty, (I) the Substantial Completion Payment shall only be adjusted as a result of a Variation if the Guaranteed Price is adjusted pursuant to Section 1.10(a)(i), and (II) neither the Guaranteed Price nor the Substantial Completion Payment shall be adjusted as a result of the Variation if Project Co is paid for Capital Expenditures pursuant to Section 1.10(a)(ii).

- (b) Contracting Authority shall make payment to Project Co within 20 Business Days following receipt by Contracting Authority of invoices presented to Contracting Authority in accordance with the agreed payment schedule accompanied (where applicable) by the relevant evidence that the relevant part of the Variation has been carried out.

- (c) Payments by Contracting Authority in respect of a Variation shall be subject to applicable holdback provisions of the Construction Act, as applicable.
- (d) Project Co shall not be entitled to any amount in excess of the amount of the Estimate confirmed in the Variation Confirmation.
- (e) Upon request by Project Co, Contracting Authority shall provide to Project Co copies of any consent or approval issued by Contracting Authority and/or Infrastructure Ontario's or Metrolinx's board of directors in connection with a proposed Variation.

1.11 Reduction in Works

- (a) If a Variation involves any reduction in the Works which results in savings in the Direct Cost to Project Co, such savings shall result in a reduction in the compensation payable to Project Co under the Project Agreement in an amount equal to such reduction in the Direct Cost and the Substantial Completion Payment (at Contracting Authority's discretion) shall be reduced accordingly.

1.12 Variation Directive

- (a) If an Estimate is not promptly agreed upon by Contracting Authority and Project Co or if there is a Dispute in relation thereto or if Contracting Authority, in its sole discretion, requires a Variation to be implemented prior to issuing a Variation Confirmation, then Contracting Authority may issue a Variation Directive and, following receipt of the Variation Directive, Project Co shall promptly proceed to implement the Variation.
- (b) Without limiting Project Co's obligation to promptly implement such Variation:
 - (i) the determination of the valuation and time extensions, if any, required in connection with such Variation, shall be made as soon as reasonably possible after commencement of the implementation of the Variation;
 - (ii) pending final determination of the valuation and time extensions, if any, required in connection with such Variation, the Independent Certifier or the Contracting Authority Representative, as applicable and, in each case, acting reasonably, shall determine the valuation in accordance with Appendices A and B hereto, with any Dispute to be determined in accordance with Schedule 27 - Dispute Resolution Procedure; and
 - (iii) Contracting Authority shall fund all Variations implemented by way of a Variation Directive as provided for in Section 1.10(a)(ii).

2. PROJECT CO VARIATIONS

2.1 General

- (a) Project Co shall deliver to Contracting Authority a written Notice (a "**Project Co Variation Notice**") for each Variation proposed by Project Co.

2.2 Project Co Variation Notice

- (a) A Project Co Variation Notice shall:
- (i) set out details of the proposed Variation in sufficient detail to enable Contracting Authority to evaluate it in full;
 - (ii) specify Project Co's reasons for proposing the Variation;
 - (iii) indicate all reasonably foreseeable implications of the Variation, including whether there are any costs or cost savings to Contracting Authority; and
 - (iv) indicate the latest date by which a Variation Enquiry must be issued.
- (b) If Contracting Authority, in its sole discretion, elects to consider the Variation proposed by Project Co, Contracting Authority may issue to Project Co a Variation Enquiry and the procedure set out in Section 1 will apply.
- (c) Project Co shall, promptly upon demand, reimburse Contracting Authority for all out-of-pocket costs and expenses reasonably incurred by Contracting Authority in connection with Contracting Authority's consideration of any Variation proposed by Project Co pursuant to Section 2 of this Schedule 22, including legal and consulting fees and disbursements, regardless of whether (i) a Variation Enquiry or Estimate is issued in connection therewith or (ii) such Variation is implemented.

APPENDIX A

CALCULATION OF DIRECT COST

1. DIRECT COST

- 1.1 Subject to Section 1.2 of this Appendix A, the term “**Direct Cost**” means the aggregate total, without duplication, of only the following amounts, as paid or incurred by Project Co or each Subcontractor, as applicable, to the extent that they specifically relate to, and are attributable to, the Variation under which Project Co is expressly entitled to its Direct Cost and would not otherwise have been incurred:
- (i) wages and benefits paid for labour in the direct employ of Project Co or each Subcontractor while performing that part of the Works on the Lands;
 - (ii) salaries, wages and benefits of Project Co’s or each Subcontractor’s personnel when stationed at the office on the Lands in whatever capacity employed, or personnel engaged at shops or on the road, in expediting the production or transportation of materials or equipment;
 - (iii) salaries, wages and benefits of Project Co’s or each Subcontractor’s office personnel engaged in a technical capacity;
 - (iv) without limiting Sections 1.1(i), 1.1(ii) and 1.1(iii) of this Appendix A, contributions, assessments or taxes incurred for such items as employment insurance, provincial health insurance, workers’ compensation, and Canada Pension Plan, insofar as such costs are based on the wages, salaries, or other remuneration paid for employees pursuant to Sections 1.1(i), 1.1(ii) and 1.1(iii) of this Appendix A, but excluding for certainty all income taxes on such wages, salaries and other remuneration;
 - (v) the cost of materials (including hand tools which have a retail value of \$[REDACTED] or less), products, supplies, equipment, temporary services and facilities, including transportation and maintenance thereof, which are consumed in the performance of the Variation;
 - (vi) the rental costs of all tools (excluding hand tools which have a retail value of \$[REDACTED] or less), machinery, and equipment used in the performance of the Variation, whether rented from or provided by Project Co or others, including installation, minor repair and replacement, dismantling, removal, transportation and delivery costs thereof;
 - (vii) deposits lost;
 - (viii) except as otherwise set out in this Schedule 22, a reasonable amount of profit consistent with prevailing market rates that is charged by any Subcontractor, other than the Construction Contractor and any entity not at arms-length from Project Co or the Construction Contractor;

- (ix) the reasonable fees and disbursements of the Lenders' Consultant and the external technical consultants and external legal advisors of Project Co and its Subcontractors;
- (x) the cost of third party quality assurance required by Contracting Authority, such as independent inspection and testing services;
- (xi) charges levied by Governmental Authorities, but excluding fines or penalties not related to the implementation of the Variation;
- (xii) subject to Section 1.1(iv) of this Appendix A, Taxes (and without limiting the obligation of Contracting Authority to pay HST payable by it under the Project Agreement), but excluding:
 - (A) HST;
 - (B) taxes imposed on Project Co or a Subcontractor based on or measured by income or profit or otherwise imposed under the Income Tax Act (Canada), the Income Tax Act (Ontario) or any similar statute in any other jurisdiction;
 - (C) capital taxes based on or measured by the capital of Project Co or a Subcontractor;
 - (D) taxes relating to withholdings on any payments by Project Co or a Subcontractor; and
 - (E) taxes relating to any business or activity other than the business or activities related to, and conducted for, the purposes of the Works;
- (xiii) the cost of removal and disposal of contaminants, hazardous substances, waste products and debris for which Project Co is not responsible under the Project Agreement;
- (xiv) termination payments which are required under Applicable Law to be made to employees of Project Co reasonably and properly incurred by Project Co arising as a direct result of any Variation reducing the scope of the Works, except to the extent that such termination payments are provided for in contracts of employment, agreements or arrangements that were not entered into in the ordinary course of business and on commercial arm's length terms;
- (xv) the cost of debt financing provided by the Lenders including all additional financing costs related to any delay caused by the implementation of the Variation;
- (xvi) the cost of competitively tendering any contract in relation to the proposed Variation that is required by Contracting Authority, including as a result of any Applicable Law or any policy applicable to Contracting Authority;
- (xvii) the cost of any additional insurance or performance security required or approved by Contracting Authority; and
- (xviii) the cost of obtaining all Project Co Permits, Licences, Approvals and Agreements.

- 1.2 The Direct Cost otherwise payable shall be subject to and limited by the following:
- (i) the Direct Cost shall be net of all discounts, rebates and other price reductions and benefits, which relate to the Direct Cost incurred;
 - (ii) the amount paid for materials, products, supplies and equipment incorporated into the Works as a result of the Variation shall not exceed commercially competitive rates available in the Province of Ontario for such materials, products, supplies and equipment from arms-length third party suppliers;
 - (iii) the Direct Cost with respect to the per hour cost charged by Project Co or any Subcontractor for salaried personnel shall be calculated by dividing the annual salary (inclusive of all benefits, statutory remittances and holidays) by 2080 hours;
 - (iv) the amount paid for machinery and equipment rental costs shall not exceed the prevailing competitive commercial rate for which such equipment or machinery can be obtained in the Greater Toronto Area;
 - (v) any amounts paid in accordance with this Appendix A for fees, wages, salaries and benefits charged by Project Co or any Subcontractor shall be reasonable and shall not exceed commercially competitive rates available in the Greater Toronto Area;
 - (vi) the Direct Cost shall not include:
 - (A) any cost incurred due to the failure on the part of Project Co or any Project Co Party to exercise reasonable care and diligence in its attention to the execution of that part of the Works (including any cost due to any negligence, improper work, deficiencies or breaches of contract by Project Co and/or any Subcontractor);
 - (B) the fees, costs or expenses, or any other form of compensation, paid or payable by Project Co or any Subcontractor to any person performing asset management, personnel services and/or similar, comparable or like services to or for the benefit of Project Co or any Subcontractor;
 - (C) the cost and expense of maintaining corporate offices, the cost and expense of office administration, estimation, accounting, payroll, printing, office supplies, phones and courier/postal service, the cost and expense of personnel not directly involved in the implementation of the Variation and any other overhead cost or expense;
 - (D) the cost of travel and subsistence expenses; or
 - (E) any costs or expenses associated with the participation of Project Co and any Subcontractor in the meetings described in Section 1.2(e) of this Schedule 22; and
 - (vii) Direct Cost must be quantifiable and supported by evidence and proper documentation, such as invoices, proof of payments, and detailed hourly rate information as required by Contracting Authority. Proper documentation shall include unit rates or prices and quantities for all items, including labour and materials that comprise the Direct Cost,

including for all work completed by any Subcontractor. Any Direct Cost item claimed as a percentage of any other Direct Cost item, such as a “risk contingency”, will not be permissible, unless approved by Contracting Authority in writing.

APPENDIX B

CALCULATION OF OVERHEAD AND PROFIT

- (a) “Overhead and Profit” means, for each of rows 1, 2 and 3 in Table A - Applicable Overhead and Profit, the product of:
 - (i) the Direct Cost of, as applicable, the work or services within the category described in such row, multiplied by;
 - (ii) the percentage set out in such row as determined based on the Direct Cost of the Variation.
- (b) For greater certainty, the percentages applicable to Overhead and Profit shall not be determined based on any component or components of the subject Variation.
- (c) Project Co and the Construction Contractor shall charge no more than the amount of Overhead and Profit calculated in accordance with Appendix B of this Schedule 22.
- (d) No amount for Overhead and Profit shall be charged on any other amount of Overhead and Profit.
- (e) No other methodology for the calculation of Overhead and Profit shall be permitted or apply.
- (f) Project Co acknowledges and agrees that the Overhead and Profit payable in accordance with this Schedule 22 is intended to compensate Project Co and the Construction Contractor for all costs and expenses incurred in connection with a Variation other than the Direct Cost, including all overhead, profit, office administration and the amounts expressly excluded from the Direct Cost pursuant to Section 1.2 of Appendix A of this Schedule 22.

**TABLE A
APPLICABLE OVERHEAD AND PROFIT**

Entity	Overhead and Profit		
	For a Variation with a Direct Cost under \$[REDACTED]	For a Variation with a Direct Cost of between \$[REDACTED] and \$[REDACTED]	For a Variation with a Direct Cost over \$[REDACTED]
1. Project Co (Own Work)	[REDACTED]%	[REDACTED]%	[REDACTED]%
2. Construction Contractor (Own Work)	[REDACTED]%	[REDACTED]%	[REDACTED]%
3. Construction Contractor (Subcontracted Work)	[REDACTED]	[REDACTED]	[REDACTED]

SCHEDULE 23
COMPENSATION ON TERMINATION

1. DEFINITIONS

1.1 Definitions

In this Schedule 23 – Compensation on Termination, unless the context indicates a contrary intention, terms which are defined in the Project Agreement (and not otherwise defined in this Schedule 23 – Compensation on Termination) shall have meanings given to them in the Project Agreement and the following terms shall have the following meanings:

- (a) **“Contracting Authority Default Termination Sum”** has the meaning given in Section 2.1(b) of this Schedule 23.
- (b) **“Employee Termination Payments”** means termination payments which are required under Applicable Law to be made to employees of Project Co or any Project Co Party as a direct result of terminating the Project Agreement (provided that Project Co or the relevant Project Co Party shall take commercially reasonable steps to mitigate its loss) and provided that, in calculating such amount, no account should be taken of any liabilities and obligations of Project Co or the relevant Project Co Party arising out of:
 - (i) contracts of employment or other agreements or arrangements entered into by Project Co or the relevant Project Co Party to the extent that such contracts of employment, agreements or arrangements were not entered into in connection with the Project; or
 - (ii) contracts of employment or other agreements or arrangements entered into by Project Co or the relevant Project Co Party other than in the ordinary course of business and on commercial arm’s length terms, save to the extent that amounts would have arisen if such contracts or other agreements or arrangements had been entered into in the ordinary course of business and on commercial arm’s length terms.
- (c) **“Invoice Date”** means the date that is the later of:
 - (i) the date on which Contracting Authority receives an invoice from Project Co for the relevant termination sum; and
 - (ii) the date on which Contracting Authority receives the supporting evidence required pursuant to Section 5.1(a) of this Schedule 23.
- (d) **“Junior Debt Amount”** means [REDACTED].
- (e) **“Junior Debt Makewhole”** means [REDACTED].
- (f) **“Non-Default Termination Sum”** has the meaning given in Section 4.1(b) of this Schedule 23.
- (g) **“Project Co Amount”** means any amount payable to Project Co as a return and/or profit to Project Co shown in the Financial Model, including for greater certainty any loans made or capital

contributed to Project Co by any Affiliate of Project Co or a Project Co Party, prorated by a fraction, the numerator of which is the period between the date of commencement of the Works and the Termination Date, and the denominator of which is the period between the date of commencement of the Works and the Scheduled Substantial Completion Date.

- (h) **“Project Co Default Termination Sum”** has the meaning given to it in Section 3.1(b) of this Schedule 23.
- (i) **“Senior Debt Amount”** means [REDACTED].
- (j) **“Senior Debt Makewhole”** means [REDACTED].
- (k) **“Subcontractor Losses”** means, subject to Project Co’s obligations under the Project Agreement to limit any compensation to Subcontractors, the amount reasonably and properly payable by Project Co to the Construction Contractor under the terms of the Design and Construction Contract as a direct result of the termination of the Project Agreement (including any reasonable commercial breakage fee), provided that such amount shall be reduced to the extent that Project Co or the Subcontractors fail to take commercially reasonable steps to mitigate such amount; provided that, no account should be taken of any liabilities and obligations of Project Co to the Subcontractors arising out of:
 - (i) any loss of overhead or profit of such Subcontractor relating to any period or costs after the Termination Date (save to the extent the same are properly included in any reasonable commercial breakage fee set out in any of the Ancillary Documents);
 - (ii) agreements or arrangements entered into by Project Co or the Subcontractors to the extent that such agreements or arrangements were not entered into in connection with those parties’ obligations in relation to the Project; or
 - (iii) agreements or arrangements entered into by Project Co or the Subcontractors other than in the ordinary course of business and on commercial arm’s length terms, save to the extent that amounts would have arisen if such agreements or arrangements had been entered into in the ordinary course of business and on commercial arm’s length terms.

2. COMPENSATION ON TERMINATION FOR CONTRACTING AUTHORITY DEFAULT OR CONVENIENCE

2.1 Compensation

- (a) If Project Co terminates the Project Agreement pursuant to Section 37 of the Project Agreement or Contracting Authority terminates the Project Agreement pursuant to Section 38.3 of the Project Agreement, Contracting Authority shall pay to Project Co the Contracting Authority Default Termination Sum.
- (b) The **“Contracting Authority Default Termination Sum”** shall be an amount equal to the aggregate of:
 - (i) the Senior Debt Amount and the Senior Debt Makewhole;

- (ii) the Junior Debt Amount and the Junior Debt Makewhole;
- (iii) any amount payable by Contracting Authority to Project Co in accordance with Sections 34.2(b) and 35.2(b) of the Project Agreement;
- (iv) the Employee Termination Payments and the Subcontractor Losses;
- (v) any reasonable costs properly incurred by Project Co to wind up its operations; and
- (vi) the Project Co Amount;

LESS, the aggregate (without double counting) of the following, to the extent it is a positive amount:

- (vii) all credit balances on any bank accounts held by or on behalf of Project Co on the Termination Date and the value of any insurance proceeds due to Project Co or to which Project Co would have been entitled had insurance been maintained in accordance with the requirements of the Project Agreement (save where such insurance proceeds are to be applied in reinstatement, restoration or replacement, or, in the case of third party legal liability, in satisfaction of the claim, demand, proceeding or liability or where Contracting Authority is required to procure insurances and to make proceeds available to Project Co under the Project Agreement and they have failed to do so) or sums due and payable from third parties other than sums wholly unrelated to the Works, the Project and the Project Agreement (but only when received from third parties) but excluding any claims under any Subcontracts or claims against other third parties which have not been determined or have been determined but not yet paid, provided that, in such case, Project Co shall assign any such rights and claims under the Subcontracts or claims against other third parties (other than claims against other third parties wholly unrelated to the Works, the Project and the Project Agreement) to Contracting Authority and, at no additional cost to Project Co, give Contracting Authority reasonable assistance in prosecuting such claims;
- (viii) to the extent realized before the Invoice Date, the market value of any other assets and rights of Project Co (other than those transferred to Contracting Authority pursuant to the Project Agreement) less liabilities of Project Co properly incurred in carrying out its obligations under the Project Agreement as at the Termination Date, provided that no account should be taken of any liabilities and obligations of Project Co arising out of:
 - (A) agreements or arrangements entered into by Project Co to the extent that such agreements or arrangements were not entered into in connection with Project Co's obligations in relation to the Project; or
 - (B) agreements or arrangements entered into by Project Co other than in the ordinary course of business and on commercial arm's length terms, save to the extent that liabilities and obligations would have arisen if such agreements or arrangements had been entered into in the ordinary course of business and on commercial arm's length terms; and
- (ix) amounts which Contracting Authority is entitled to set off pursuant to Section 4.11(a)(i) of the Project Agreement,

provided that the Contracting Authority Default Termination Sum shall never be less than the aggregate of the Senior Debt Amount, the Senior Debt Makewhole, the Junior Debt Amount and the Junior Debt Makewhole.

- (c) To the extent that such assets and rights referred to in Section 2.1(b)(viii) of this Schedule 23 are not realized and applied pursuant thereto, Project Co shall, on payment of the Contracting Authority Default Termination Sum, assign such assets and rights to Contracting Authority.
- (d) Contracting Authority shall pay the Contracting Authority Default Termination Sum in accordance with Section 5 of this Schedule 23.

3. COMPENSATION ON TERMINATION FOR PROJECT CO DEFAULT

3.1 Compensation

- (a) If Contracting Authority terminates the Project Agreement pursuant to Section 36 of the Project Agreement, Contracting Authority shall pay to Project Co the Project Co Default Termination Sum.
- (b) The “**Project Co Default Termination Sum**” shall be an amount equal to the Guaranteed Price, as adjusted in accordance with the terms of the Project Agreement as of the Termination Date, less the aggregate, without duplication, of each of the following:
 - (i) any amount of the of the First Milestone Payment, Second Milestone Payment, Substantial Completion Payment and any other amounts paid by Contracting Authority on or before the Termination Date;
 - (ii) Contracting Authority’s estimate of the cost to complete the Works, including the cost to remedy any defective or deficient Works determined on a reasonable basis in consultation with the Independent Certifier and Contracting Authority’s other consultants and including all reasonable and proper costs incurred by Contracting Authority in re-tendering the Works or any portion thereof;
 - (iii) Contracting Authority’s estimate of the aggregate of all Direct Losses suffered, sustained or incurred by Contracting Authority as a result of, in respect of, or arising out of the event or events which resulted in the termination of the Project Agreement and arising out of the termination together with all costs of entering into a new design and construction contract to complete the Works, including any warranty obligations for the Works in place and to be performed, on substantially the same terms and conditions as the Project Agreement;
 - (iv) the Completion Holdback, in each case as at the time the Project Co Default Termination Sum is required to be made;
 - (v) the Legislative Holdback required to be maintained by Contracting Authority as at the time the Project Co Default Termination Sum is required to be made, which amount will be paid by Contracting Authority in accordance with the Construction Act; and
 - (vi) amounts which Contracting Authority are entitled to set off pursuant to Section 4.11(a)(i) of the Project Agreement.

- (c) To the extent that any amounts that Contracting Authority has estimated or determined pursuant to Sections 3.1(b)(ii), 3.1(b)(iii) or 3.1(b)(iv) of this Schedule 23, are in excess of what is required by Contracting Authority to complete the Work or compensate for Direct Losses, the Completion Holdback or the Legislative Holdback, as applicable, Contracting Authority shall promptly return such excess amounts to Project Co.
- (d) Contracting Authority shall pay the Project Co Default Termination Sum in accordance with Section 5 of this Schedule 23.

4. CONSEQUENCES OF NON-DEFAULT TERMINATION AND TERMINATION FOR RELIEF EVENT

4.1 Consequences

- (a) If either Party terminates the Project Agreement pursuant to Section 38.1 of the Project Agreement or if either Party terminates the Project Agreement pursuant to Section 38.2 of the Project Agreement, Contracting Authority shall pay to Project Co the Non-Default Termination Sum.
- (b) The “**Non-Default Termination Sum**” shall be an amount equal to the aggregate of:
 - (i) the Senior Debt Amount and the Senior Debt Makewhole;
 - (ii) the Junior Debt Amount;
 - (iii) any amount payable by Contracting Authority to Project Co in accordance with Sections 34.2(b) and 35.2(b) of the Project Agreement; and
 - (iv) the Employee Termination Payments and the Subcontractor Losses (but excluding therefrom any claims for loss of profit);

LESS, the aggregate (without double counting) of the following, to the extent it is a positive amount:

- (v) all credit balances on any bank accounts held by or on behalf of Project Co on the Termination Date and the value of any insurance proceeds due to Project Co or to which Project Co would have been entitled had insurance been maintained in accordance with the requirements of the Project Agreement (save where such insurance proceeds are to be applied in reinstatement, restoration or replacement, or, in the case of third party legal liability, in satisfaction of the claim, demand, proceeding or liability or where Contracting Authority are required to procure insurances and to make proceeds available to Project Co under the Project Agreement and it has failed to do so) or sums due and payable from third parties other than sums wholly unrelated to the Works, the Project and the Project Agreement (but only when received from third parties) but excluding any claims under any Subcontracts or claims against other third parties which have not been determined or have been determined but not yet paid, provided that, in such case, Project Co shall assign any such rights and claims under the Subcontracts or claims against other third parties (other than claims against other third parties wholly unrelated to the Works, the Project and the Project Agreement) to Contracting Authority and, at no additional cost to Project Co, give Contracting Authority reasonable assistance in prosecuting such claims; and

- (vi) to the extent realized before the Invoice Date, the market value of any other assets and rights of Project Co (other than those transferred to Contracting Authority pursuant to the Project Agreement) less liabilities of Project Co properly incurred in carrying out its obligations under the Project Agreement as at the Termination Date, provided that no account should be taken of any liabilities and obligations of Project Co arising out of:
 - (A) agreements or arrangements entered into by Project Co to the extent that such agreements or arrangements were not entered into in connection with Project Co's obligations in relation to the Project; or
 - (B) agreements or arrangements entered into by Project Co other than in the ordinary course of business and on commercial arm's length terms, save to the extent that liabilities and obligations would have arisen if such agreements or arrangements had been entered into in the ordinary course of business and on commercial arm's length terms; and
- (vii) amounts which Contracting Authority are entitled to set off pursuant to Section 4.11(a)(i) of the Project Agreement,

provided that the Non-Default Termination Sum shall never be less than the aggregate of the Senior Debt Amount, the Senior Debt Makewhole and the Junior Debt Amount.

- (c) To the extent that such assets and rights referred to in Section 4.1(b)(vi) of this Schedule 23 are not realized and applied pursuant thereto, Project Co shall, on payment of the Non-Default Termination Sum, assign such assets and rights to Contracting Authority.
- (d) Contracting Authority shall pay the Non-Default Termination Sum in accordance with Section 5 of this Schedule 23.

5. GENERAL

5.1 Payment and Interest Following Termination

- (a) In respect of the termination payments to be made pursuant to either Section 2 or 4 of this Schedule 23, as soon as practicable after, and, in any event, within 30 days after, the Termination Date, Project Co shall give to Contracting Authority an invoice for the relevant termination sum and sufficient supporting evidence, reasonably satisfactory to Contracting Authority, justifying the amount of the relevant termination sum including a detailed breakdown of each of the individual items comprising such sum.
- (b) In respect of the termination payments to be made pursuant Section 3 of this Schedule 23, as soon as practicable, and in any event, within 120 days after the Termination Date, Contracting Authority shall calculate and notify Project Co of the Project Co Default Termination Sum under Section 3.1(b) of this Schedule 23, and shall deliver to Project Co sufficient supporting evidence reasonably satisfactory to Project Co.
- (c) Contracting Authority shall:

- (i) pay to Project Co the relevant termination sum within 60 days after the Invoice Date or the date of delivery of the Notice described in Section 5.1(b) of this Schedule 23, as applicable, and so long as all of demobilization of the Works has been completed; and
- (ii) indemnify Project Co as provided in Section 46.2(d) of the Project Agreement in respect of any damages suffered or incurred as a result of the relevant termination sum (or any part of such sum that remains outstanding) not being received on the Termination Date:
 - (A) in an amount equivalent to the No Default Payment Compensation Amount for the period from (but excluding) the Termination Date to (and including) the date which is 60 days after the Invoice Date or the date of delivery of the Notice described in Section 5.1(b) of this Schedule 23, as applicable; and
 - (B) thereafter, in an amount equivalent to the Payment Compensation Amount until the date of payment.
- (d) In respect of the termination payments to be made pursuant to Section 3 of this Schedule 23, if the applicable termination sum is negative, Contracting Authority shall have no obligation to make any payment to Project Co and Project Co shall also thereafter indemnify Contracting Authority as provided in Section 46.1(e) of the Project Agreement in respect of any damages suffered or incurred on such amount on the basis that the due date for the payment of the negative termination sum amount was the date 60 days after the Invoice Date until the date of payment in an amount equivalent to the Payment Compensation Amount.

5.2 Costs

- (a) The costs and expenses to be taken into account in the calculation of all termination sums due pursuant to this Schedule 23 shall only be such costs and expenses to the extent that they are reasonable and proper in quantum and shall have been or will be reasonably and properly incurred.

5.3 Undisputed Amounts

- (a) If the calculation of any termination amount is disputed then any undisputed amount shall be paid in accordance with this Section 5 and the disputed amount shall be dealt with in accordance with Schedule 27 – Dispute Resolution Procedure.

5.4 Outstanding Debt Amounts

- (a) Contracting Authority shall be entitled to rely on a certificate of the Lenders' Agent as conclusive as to the Senior Debt Amount, the Senior Debt Makewhole, the Junior Debt Amount and the Junior Debt Makewhole, as applicable, outstanding or payable at any relevant time.
- (b) If a receipt or other acknowledgement is given by the Lenders' Agent acknowledging or otherwise confirming receipt of payment or payments in respect of the Senior Debt Amount, the Senior Debt Makewhole, the Junior Debt Amount and the Junior Debt Makewhole, as applicable, such receipt or other acknowledgement shall discharge Contracting Authority's obligation to pay such portion of compensation due to Project Co that is equal to the amount acknowledged or confirmed.

SCHEDULE 24

INTELLECTUAL PROPERTY

1. INTERPRETATION

1.1 Definitions: In this Schedule 24 – Intellectual Property, unless the context indicates a contrary intention, terms which are defined in the Project Agreement (and not otherwise defined in this Schedule 24 – Intellectual Property) shall have meanings given to them in the Project Agreement and the following terms shall have the following meanings:

- (a) **“Assigned Intellectual Property”** has the meaning given in Section 2.5(a).
- (b) **“Assignee”** has the meaning given in Section 2.5(a).
- (c) **“Assignor”** has the meaning given in Section 2.5(a).
- (d) **“Contracting Authority Intellectual Property”** means:
 - (i) Intellectual Property that is Owned, created, developed or acquired by Contracting Authority or any Contracting Authority Personnel:
 - (A) prior to the Project Term; or
 - (B) during the Project Term but outside the Project Scope; or
 - (C) during the Project Term and within the Project Scope, but which is not Project Co Intellectual Property, Subcontractor Intellectual Property or Third Party Intellectual Property;
 - (ii) the Developed Intellectual Property, excluding any Developed Intellectual Property that is specified in a Variation or by separate agreement of Contracting Authority and Project Co to be Owned by Project Co;
 - (iii) any other Project Data that is specified in a Variation or by separate agreement of Contracting Authority and Project Co to be Owned by Contracting Authority; and
 - (iv) subject to Section 41.4 of the Project Agreement, all Modifications to any of the foregoing, whether made by or on behalf of Project Co, Contracting Authority or any Subcontractor alone, jointly with each other or with any other person;

and which is used by Contracting Authority, or required to be used by Project Co or a Subcontractor, in the performance of their respective obligations in respect of the Project or under the Project Agreement.
- (e) **“Contracting Authority Personnel”** means persons acting on behalf of Contracting Authority or employed, engaged or retained by Contracting Authority in connection with the performance of Contracting Authority’s obligations in connection with the Project, including Contracting Authority’s consultants, contractors and subcontractors and the employees, officers, directors,

volunteers and agents of Contracting Authority and its direct and indirect consultants, contractors and subcontractors, excluding Project Co and any Subcontractor and their respective Personnel.

- (f) **“Contracting Authority Supplied Third Party Intellectual Property”** means Intellectual Property, Owned by a person other than Contracting Authority, Project Co, a Subcontractor or any of their respective Personnel that is delivered, supplied or otherwise provided by Contracting Authority to Project Co under the Project Agreement for the purpose of performing the Works and the Project, including any Background Information.
- (g) **“Contracting Authority Trade-Marks”** means the Trade-Marks Owned by Contracting Authority.
- (h) **“Copyleft Licence”** means any licence that requires, as a condition of use, modification and/or distribution of Copyleft Materials, that such Copyleft Materials, or other software or content incorporated into, derived from, used, or distributed with such Copyleft Materials: (i) in the case of software, be made available or distributed in a form other than binary (for example, source code form), (ii) be licenced for the purpose of preparing derivative works, (iii) be licenced under terms that allow the products or portions thereof or interfaces therefor to be reverse engineered, reverse assembled or disassembled (other than by operation of law), or (iv) be redistributable at no licence fee. Copyleft licences include the GNU General Public Licence, the GNU Lesser General Public Licence, the Mozilla Public Licence, the Common Development and Distribution Licence, the Eclipse Public Licence, and all Creative Commons “sharealike” licences.
- (i) **“Copyleft Materials”** means any software or content subject to a Copyleft Licence.
- (j) **“Deliverable”** means any item required to be supplied or delivered by Project Co to Contracting Authority within the Project Scope, including Equipment, Project Software, Project Data and all other deliverable requirements specified in Schedule 10 – Review Procedure.
- (k) **“Delivered”** means, with respect to any Intellectual Property, that such Intellectual Property is:
- (i) a Deliverable;
 - (ii) incorporated, embedded or otherwise included in any Deliverable, the System or any part of the work delivered as part of the Works;
 - (iii) necessary for the undertaking, completion and performance of the Works or any Equivalent Activity; or
 - (iv) necessary for the Use by Contracting Authority or a subsequent Licensee of any Deliverable, the System, or any part of the work delivered as part of the Works or any Intellectual Property in accordance with the rights granted to Contracting Authority hereunder;
- or that the Use of such Intellectual Property for any of the purposes set out in clause (iii) or (iv) above would infringe the Intellectual Property rights of any person.
- (l) **“Developed Intellectual Property”** means Intellectual Property that is:

- (i) created or developed, or Ownership of which is acquired, by Project Co, any Subcontractor or any Project Co Personnel, or Subcontractor Personnel, whether alone or together with each other or any other person, during the Project Term and within the Project Scope;
 - (ii) created, developed or Ownership of which is acquired for the purposes of the Project, the Works or the System; and
 - (iii) created or designed based on functional, design and performance specifications provided by Contracting Authority, or Contracting Authority Personnel, or Contracting Authority Parties;
- and, for greater certainty, Developed Intellectual Property does not include any Project Co Intellectual Property used to develop or create the Developed Intellectual Property.
- (m) **“Embedded Software”** means the Project Co Embedded Software, Subcontractor Embedded Software and Third Party Embedded Software.
 - (n) **“Equipment”** means all electrical and mechanical equipment, machinery, computer hardware and systems comprising or used in the System.
 - (o) **“Equivalent Activity”** means any activity, undertaking or operation relating to the System done by Contracting Authority, any permitted assignee of Contracting Authority pursuant to Section 49.2 of the Project Agreement and/or any other person acting on behalf of or under the authority of Contracting Authority, which activity, undertaking or operation if done by Project Co would be within the Project Scope, including the Works.
 - (p) **“Escrow Agent”** means a recognized provider of escrow services selected by Project Co and approved by Contracting Authority and having a location within the Province of Ontario with whom the Escrow Materials will be deposited in accordance with Section 3.11.
 - (q) **“Escrow Agreement”** means an escrow agreement that meets the requirements of Section 3.11 and pursuant to which Escrow Materials are held by the Escrow Agent and Contracting Authority are designated as a beneficiary party.
 - (r) **“Escrow Materials”** means:
 - (i) with respect to Software, the Source Materials for that Software; and
 - (ii) with respect to Embedded Software, the Source Materials for that Embedded Software.
 - (s) **“Escrow Provider”** means:
 - (i) Project Co in respect of the Project Co Licenced Software;
 - (ii) the applicable Subcontractor in respect of any Subcontractor Licenced Software;
 - (iii) the applicable third party licensor in respect of any Third Party Licenced Software;
 - (iv) Project Co in respect of the Project Co Embedded Software;

- (v) the applicable Subcontractor in respect of any Subcontractor Embedded Software; and
- (vi) the applicable third party licensor in respect of any Third Party Embedded Software.
- (t) **“Expanded Purposes”** means (i) the Permitted Purposes; and (ii) for any other purpose of Metrolinx.
- (u) **“Licence”** means a non-exclusive licence or sub-licence, as applicable, granting the rights and subject to the restrictions and limitations set out in this Schedule 24.
- (v) **“Licenced Intellectual Property”** means, with respect to any Licence, the Intellectual Property that is within the scope of that Licence as provided for in this Schedule 24.
- (w) **“Licensee”** means, in respect of any Licence granted or required to be granted by Project Co pursuant to this Schedule 24, Contracting Authority or any permitted assignee under Section 49.2 of the Project Agreement that is the holder of that Licence at the relevant time.
- (x) **“Licensor”** means Project Co in respect of the Project Co Licenced Software, the applicable Subcontractor in respect of any Subcontractor Licenced Software, or the applicable third party licensor in respect of any Third Party Licenced Software.
- (y) **“Limited Modification Rights”** in respect of a Software or an Embedded Software, means the right to configure, customize or modify such Software or Embedded Software, without access to the Source Materials thereto, in order to have complete and unrestricted access to, or otherwise Use, all the functionalities within such Software or Embedded Software that is licenced to Contracting Authority under this Schedule 24.
- (z) **“Modification”** means all corrections, modifications, changes, enhancements, improvements, supplements, customizations or derivative works, and includes the Limited Modification Rights, and **“Modify”** means to make a Modification.
- (aa) **“Open Source Licence”** means any licence meeting the Open Source Definition (as promulgated by the Open Source Initiative) or the Free Software Definition (as promulgated by the Free Software Foundation), or any substantially similar licence, including any licence approved by the Open Source Initiative, or any Creative Commons Licence. For the avoidance of doubt, Open Source Licences include Copyleft Licences.
- (bb) **“Open Source Materials”** means any software or content subject to an Open Source Licence.
- (cc) **“Ownership”** means, in respect of any Intellectual Property, ownership of all right, title and interest in and to that Intellectual Property, and **“Own”**, **“Owned”** and **“Owner”** shall have corresponding meanings.
- (dd) **“Permitted Purposes”** means:
 - (i) during the Project Term, performance of Contracting Authority’s obligations and the exercise of Contracting Authority’s rights under the Project Agreement and any other agreements relating to the Project;

- (ii) during the Project Term, Contracting Authority's participation in the Works and any activity, undertaking or operation within the Project Scope, including its participation in the design, construction, operation, maintenance, repair, correction and renovation of the System;
- (iii) after the Project Term, any Equivalent Activity;
- (iv) both during and after the Project Term, the use, integration and interoperation of the System with:
 - (A) any existing or other transit projects undertaken by or on behalf of Contracting Authority or interfacing with Contracting Authority projects; and
 - (B) any existing or after-acquired systems, software, technology or equipment related to the use, operation, maintenance, repair, correction, and renovation of the System;

but, for clarity, not any system that is not the System;
- (v) both during and after the Project Term, the integration and interoperation of the System with any existing or other transit projects undertaken by or on behalf of Contracting Authority or interfacing with Contracting Authority projects;
- (vi) both during and after the Project Term, and so long as the Licensee is Contracting Authority or other Governmental Authority:
 - (A) the provision of governmental services and the conduct of operations and activities provided in connection or otherwise associated with the System and the Lands by Contracting Authority or any Governmental Authority or any emergency service provider; and
 - (B) the development of transportation standards, policies and procedures.
- (ee) **"Personnel"** means (i) in reference to Project Co, the Project Co Personnel, (ii) in reference to Contracting Authority, Contracting Authority Personnel, and (iii) in reference to any Subcontractor, such Subcontractor's Personnel.
- (ff) **"Project Co Embedded Software"** means computer software that is Owned by Project Co and that:
 - (i) is included, embedded or otherwise incorporated in Equipment;
 - (ii) is not licenced separately and apart from that Equipment; and
 - (iii) is not subject to a separate warranty, and is not subject to maintenance and repair separately from, that Equipment.
- (gg) **"Project Co Intellectual Property"** means:

- (i) Intellectual Property that is Owned, created, developed or acquired by Project Co or any Project Co Personnel:
 - (A) prior to the Project Term; or
 - (B) during the Project Term but outside the Project Scope; or
 - (C) during the Project Term and within the Project Scope, but which is not Contracting Authority Intellectual Property, Contracting Authority Supplied Third Party Intellectual Property, Subcontractor Intellectual Property, or Third Party Intellectual Property;
- (ii) the Project Co Licenced Software;
- (iii) the Project Co Embedded Software;
- (iv) Project Co's Technical Information;
- (v) the Project Intellectual Property;
- (vi) the Project Data, excluding any other Project Data that are specified in a Variation or by separate agreement of Contracting Authority and Project Co to be Owned by Contracting Authority;
- (vii) any Developed Intellectual Property that is specified in a Variation or by separate agreement of Contracting Authority and Project Co to be Owned by Project Co; and
- (viii) Subject to Section 41.4 of the Project Agreement, all Modifications to any of the foregoing, whether made by or on behalf of Project Co, Contracting Authority, Contracting Authority Parties, or any Subcontractor alone, jointly with each other or with any other person.
- (hh) **"Project Co Licenced Software"** means any computer software that is Owned by Project Co, is not Project Co Embedded Software and is delivered, supplied or otherwise provided by Project Co under the Project Agreement as or as part of any Deliverable.
- (ii) **"Project Co Personnel"** means persons acting on behalf of Project Co or employed, engaged or retained by Project Co in connection with the performance of Project Co's obligations under the Project Agreement, including Project Co's consultants, contractors and Subcontractors and the employees, officers, directors, volunteers and agents of Project Co and its direct and indirect consultants, contractors and Subcontractors.
- (jj) **"Project Data"** means:
 - (i) all Design Data; and
 - (ii) any other materials, documents and/or data prepared by or on behalf of Project Co or Subcontractors in relation to the Works, the System or the Project Agreement, excluding the Jointly Developed Materials, the Background Information and any Developed Intellectual Property.

- (kk) **“Project Intellectual Property”** means Intellectual Property that is created or developed, or Ownership of which is acquired, by Project Co, any Subcontractor or any Project Co Personnel or Subcontractor Personnel, whether alone or together with each other or any other person, during the Project Term and within the Project Scope, and which is created, developed or acquired for the purposes of the Project or the System, but excluding Project Software, Embedded Software, Project Data, Developed Intellectual Property and Technical Information.
- (ll) **“Project Scope”** means the scope of the Project, including the performance of all Works, as defined by the terms of the Project Agreement.
- (mm) **“Project Software”** or **“Software”** means any Project Co Licenced Software, Subcontractor Licenced Software and Third Party Licenced Software, but does not include Embedded Software.
- (nn) **“Software Maintenance and Support”** means, with respect to any Software, the software maintenance and support services for that Software that are provided separately under a software maintenance and support agreement with the licensor of that Software.
- (oo) **“Software Tools”** means, with respect to any Software or Embedded Software, any routines, compilers, bootstraps, analyzers, monitors, toolkits and other software tools used by the licensor of such Software or Embedded Software in connection with the programming, compiling, maintenance, debugging, analysis, configuration, customization, verification or monitoring of such Software or Embedded Software.
- (pp) **“Source Materials”** means:
- (i) a complete source code version of the Software or Embedded Software, in machine-readable form which, when compiled, will produce the executable version of the Software or Embedded Software and in human-readable form with annotations in the English language or such other language as is acceptable to Contracting Authority, acting reasonably, in both cases on a storage medium suitable for long term archival storage;
 - (ii) a complete copy, in English or such other language as is acceptable to Contracting Authority, acting reasonably, in both electronic and paper form, suitable for long term archival storage, and appropriately labelled to describe the contents thereof, of all applicable documentation and other explanatory materials, including programmer’s notes, technical or otherwise, for the Software or Embedded Software as may be required for a person other than the licensor of the Software or Embedded Software, using a competent computer programmer possessing ordinary skills and experience, to further develop, maintain and operate the Software or Embedded Software without further recourse to the licensor, which will include, to the extent such items have been or are created for such Software or Embedded Software, general flow charts, input and output layouts, field descriptions, volumes and sort sequence, data dictionary, file layouts, processing requirements and calculation formulae, circuit diagrams and the details of all algorithms and which shall be deemed to include those materials, as revised from time to time; and
 - (iii) all Software Tools for such Software or Embedded Software, to the extent not previously delivered with the Software or Embedded Software.

- (qq) **“Subcontractor Embedded Software”** means computer software that is Owned by a Subcontractor and that:
- (i) is included, embedded or otherwise incorporated in Equipment;
 - (ii) is not licenced separately and apart from that Equipment; and
 - (iii) is not subject to a separate warranty, and is not subject to maintenance and repair separately from, that Equipment.
- (rr) **“Subcontractor Intellectual Property”** means, with respect to each Subcontractor:
- (i) Intellectual Property that is Owned, created, developed or acquired by that Subcontractor:
 - (A) prior to the Project Term; or
 - (B) during the Project Term but outside the Project Scope; or
 - (C) during the Project Term and within the Project Scope, but which is not Contracting Authority Intellectual Property, Contracting Authority Supplied Third Party Intellectual Property, Project Co Intellectual Property, or Third Party Intellectual Property;
 - (ii) the Subcontractor Licenced Software;
 - (iii) the Subcontractor Embedded Software;
 - (iv) the Subcontractor’s Technical Information; and
 - (v) subject to Section 41.4 of the Project Agreement, all Modifications to any of the foregoing, whether made by or on behalf of Project Co, Contracting Authority, Contracting Authority Parties, or any Subcontractor alone, jointly with each other or with any other person.
- (ss) **“Subcontractor Licenced Software”** means any computer software that is Owned by a Subcontractor, is not Subcontractor Embedded Software and is delivered, supplied or otherwise provided by the Subcontractor under the Project Agreement, the Subcontract as or as part of any Deliverable.
- (tt) **“Subcontractor Personnel”** means, with respect to any Subcontractor, persons acting on behalf of that Subcontractor or employed, engaged or retained by that Subcontractor in connection with the performance of that Subcontractor’s obligations under the Project Agreement or the Subcontract, including the Subcontractor’s consultants, contractors and subcontractors and the employees, officers, directors, volunteers and agents of the Subcontractor and its direct and indirect consultants, contractors and subcontractors.
- (uu) **“System Architecture and Look and Feel”** means any work product, including any Intellectual Property therein, Owned, created, developed, acquired or licenced whether by Project Co or any Subcontractor in respect of any aspect of the architecture or look and feel of the System, including all designs, design details, drawings, specifications, prototypes, documentation, works and all

instruments of architectural service that relate to the design identity, look and feel of any aspect of the architectural and landscape design whether in respect of the landscape and urban design elements, furniture, fit and finish, or any other aspect of the System.

- (vv) **“Technical Information”** means technical information relating to any Equipment supplied or Intellectual Property licenced under the Project Agreement, including software documentation, user and operating manuals, maintenance and repair manuals, parts lists and other materials relevant to the use, operation, maintenance or repair of such Equipment or Intellectual Property.
- (ww) **“Third Party Embedded Software”** means computer software that is not Owned by Contracting Authority, Project Co or a Subcontractor and that:
- (i) is included, embedded or otherwise incorporated in Equipment;
 - (ii) is not licenced separately and apart from that Equipment; and
 - (iii) is not subject to a separate warranty, and is not subject to maintenance and repair separately from, that Equipment.
- (xx) **“Third Party Intellectual Property”** means Intellectual Property Owned by a person other than Contracting Authority, Project Co, a Subcontractor or any of their respective Personnel that is delivered, supplied or otherwise provided by Project Co or a Subcontractor under the Project Agreement as or as part of any Deliverable, including Third Party Licenced Software and Third Party Embedded Software.
- (yy) **“Third Party Licenced Software”** means any computer software that is not Owned by Contracting Authority, Project Co or a Subcontractor, is not Third Party Embedded Software and is delivered, supplied or otherwise provided by Project Co or a Subcontractor under the Project Agreement as or as part of any Deliverable.
- (zz) **“Trade-Mark Licence Agreement”** means the trademark licence agreement entered into between Project Co and Contracting Authority providing for the licence by Contracting Authority of Contracting Authority Trade-Marks to Project Co, being substantially in the form of Appendix A attached to this Schedule 24.
- (aaa) **“Trust Rights”** has the meaning given in Section 2.5(b).
- (bbb) **“Use”** means, with respect to any Intellectual Property, to do any and all things with that Intellectual Property that the Owner of that Intellectual Property could do, including to load, transmit, access, execute, use, store, display, copy, adapt, translate, incorporate into other materials, practice, make and have made, but specifically excluding the right to Modify and subject to any limitations in the provision of this Schedule 24 pursuant to which a Licence is granted.

2. OWNERSHIP

- 2.1 Project Co Intellectual Property:** Project Co shall be and remain the sole and exclusive Owner of the Project Co Intellectual Property. For certainty, nothing in this Schedule 24 shall transfer to Project Co any Ownership of, or grant to Project Co any right in respect of, Contracting Authority Intellectual Property used in the creation or development of or that is embodied, incorporated,

embedded, otherwise included or illustrated in any Project Co Intellectual Property, except for the Licence granted under Section 3.1.

- 2.2 Contracting Authority Intellectual Property:** Contracting Authority shall be and remain the sole and exclusive Owner of Contracting Authority Intellectual Property. For certainty, nothing in this Schedule 24 shall transfer to Contracting Authority any Ownership of, or grant to Contracting Authority any right in respect of, the Project Co Intellectual Property used in the creation or development of or that is embodied, incorporated, embedded, otherwise included or illustrated in any Contracting Authority Intellectual Property, except for the Licence granted under Section 3.2.

For greater clarity and without limiting Contracting Authority's Ownership rights, Project Co acknowledges and agrees that Contracting Authority shall be entitled to Use and Modify the Developed Intellectual Property (other than any Developed Intellectual Property that is specified in a Variation or by separate agreement of Contracting Authority and Project Co to be Owned by Project Co) in any manner and for any purpose whatsoever, including in connection with the Expanded Purposes.

- 2.3 Subcontractor Intellectual Property:** As between Contracting Authority and Project Co, but subject to any agreement to the contrary between Project Co and any Subcontractor, each Subcontractor shall be and remain the sole and exclusive Owner of its Subcontractor Intellectual Property.

- 2.4 Contracting Authority Supplied Third Party Intellectual Property:** As between Contracting Authority and Project Co, but subject to any agreement to the contrary between Contracting Authority and the Owner of any Contracting Authority Supplied Third Party Intellectual Property, the Owner of any Contracting Authority Supplied Third Party Intellectual Property shall be and remain the sole and exclusive Owner of any Contracting Authority Supplied Third Party Intellectual Property. For certainty, nothing in this Schedule 24 shall transfer to Project Co or any Subcontractor any Ownership of, or grant to Project Co or any Subcontractor any right in respect of, Contracting Authority Supplied Third Party Intellectual Property used in the creation or development of or that is embodied, incorporated, embedded, otherwise included or illustrated in any Project Co Intellectual Property or any Contracting Authority Intellectual Property or any Subcontractor Intellectual Property, except for the Licence granted under Section 3.1.

2.5 Assignments

- (a) If, notwithstanding Section 2.1, 2.2, 2.3, or 2.4 or Section 41.4 of the Project Agreement, either party (the "**Assignor**") retains, acquires or owns any right, title or interest in or to any Intellectual Property that is to be Owned by another person (the "**Assignee**") pursuant to Section 2.1, 2.2, 2.3, or 2.4 or Section 41.4 of the Project Agreement as applicable, (the "**Assigned Intellectual Property**"), then the Assignor will assign, and for no further consideration and without any further act or formality does hereby irrevocably assign, to the Assignee all of the Assignor's worldwide right, title and interest in and to the Assigned Intellectual Property free and clear of all liens, claims, charges or encumbrances, but subject to any Licences granted or required to be granted by the Assignee to the Assignor pursuant to this Schedule 24.
- (b) If and to the extent that the assignment pursuant to Section 2.5(a) is not effective on the date hereof or on any future date, either generally or pursuant to the laws of any jurisdiction, then any and all right, title and interest in and to the Assigned Intellectual Property that is retained, acquired or

owned by the Assignor (collectively, the “**Trust Rights**”), will be held by the Assignor in trust for the exclusive benefit and use of the Assignee, except for any Licences granted or required to be granted by the Assignee to the Assignor pursuant to this Schedule 24, and the Assignor will execute and deliver to the Assignee such transfers, assignments, documents and instruments as may be necessary to transfer and assign to the Assignee the Trust Rights, free and clear of all liens, claims, charges or encumbrances, promptly upon receipt thereof from the Assignee, and will otherwise cooperate with the Assignee to give effect to, record and register the Assignee’s ownership of the Trust Rights.

- (c) Project Co will include in each Subcontract provisions equivalent to Sections 2.5(a) or 2.5(b) with respect to: (i) Contracting Authority Intellectual Property, Jointly Developed Materials, Developed Intellectual Property, Project Data and any Modifications thereto, and shall enforce those provisions against each Subcontractor to the extent necessary to ensure that Contracting Authority remains at all times the sole and exclusive Owner of all such property; and (ii) Contracting Authority Supplied Third Party Intellectual Property and any Modifications thereto, and shall enforce those provisions against each Subcontractor to the extent necessary to ensure that the Licensor, as applicable, remains at all times the sole and exclusive Owner of all such property.

2.6 Personnel: Contracting Authority and Project Co shall, and Project Co shall include in each Subcontract an obligation of each Subcontractor to, ensure that their respective Personnel shall:

- (a) by duly executed written agreement or by operation of law, irrevocably and unconditionally sell, assign and transfer to that party all right, title and interest that its Personnel may have in or to any and all Intellectual Property referred to in this Schedule 24 and all Modifications thereto, such that agreements as to Ownership of Intellectual Property pursuant to Sections 2.1, 2.2, 2.3, or 2.4 and Section 41.4 of the Project Agreement and the assignment by that party pursuant to Section 2.5 include all right, title and interest of its Personnel; and
- (b) by duly executed written agreement, irrevocably waive all non-transferable rights, including moral rights, that they have or may have in any Intellectual Property assigned by such Personnel pursuant to Section 2.6(a) in favour of the assignee and its successors, assigns and licensees.

3. LICENCES

3.1 Licence by Contracting Authority to Project Co

- (a) Subject to Section 3.1(d), Contracting Authority hereby grant to Project Co:
 - (i) a royalty free, fully paid-up, limited Licence to Use and Modify Contracting Authority Intellectual Property for the sole purpose of and only to the extent necessary for the performance by Project Co of the Project Scope and its obligations under the Project Agreement;
 - (ii) a limited Licence to Use Contracting Authority Supplied Third Party Intellectual Property for the sole purpose of and only to the extent necessary for the performance by Project Co of the Project Scope and its obligations under the Project Agreement.

- (b) Subject to Section 3.1(d), Project Co may sublicense its rights under the Licence granted in Section 3.1(a) to any Subcontractor for the sole purpose of and only to the extent necessary for the performance by that Subcontractor of its obligations under its Subcontract.
- (c) Except as provided in Section 3.1(b), Project Co may not transfer, assign, sublicense or otherwise dispose of the Licence granted under Section 3.1(a) without the prior written consent of Contracting Authority, which consent may be given or refused by Contracting Authority in its absolute and unfettered discretion.
- (d) The Licence of any Contracting Authority Supplied Third Party Intellectual Property pursuant to Section 3.1(a) shall be subject to the terms and conditions of the licence agreement between Contracting Authority and the licensor of Contracting Authority Supplied Third Party Intellectual Property. The Contracting Authority will provide to Project Co a copy of any such third party licence agreement (which may be redacted as to financial and other terms not relevant to use of Contracting Authority Supplied Third Party Intellectual Property by Project Co and Subcontractors), or where prohibited from doing so by obligations of confidentiality to the third party licensor, a summary of the obligations, limitations and restrictions applicable to use of Contracting Authority Supplied Third Party Intellectual Property by Project Co and Subcontractors. Project Co will comply, and will require any Subcontractor to comply, with the terms and conditions of such third party licence agreement (as set out in the copy of the third party licence agreement or summary thereof provided by Contracting Authority to Project Co) to the extent applicable to Project Co and any Subcontractor in the performance of their respective obligations under the Project Agreement and any Subcontract. If requested by Contracting Authority, Project Co will, and will require any Subcontractor to, execute and deliver to Contracting Authority and the third party licensor an agreement that includes reasonable terms for the protection of the confidentiality of Contracting Authority Supplied Third Party Intellectual Property and an acknowledgement of the third party licensor's ownership thereof, unless Project Co disputes such ownership.
- (e) The Licence granted to Project Co under: Section 3.1(a)(i), and any sublicense granted by Project Co to a Subcontractor thereunder, will terminate upon the expiry or termination of Project Co's services and other obligations under the Project Agreement; Section 3.1(a)(ii) and any sublicense granted by Project Co to a Subcontractor thereunder, will terminate upon the earlier of: (i) expiry or termination of Project Co's services and other obligations under the Project Agreement; and (ii) the termination of the contract in respect of the applicable Contracting Authority Supplied Third Party Intellectual Property or Contracting Authority's licence or sublicense rights thereunder.
- (f) The Licences granted to Project Co under Section 3 do not include licences to any Contracting Authority Trade-Marks. The use of any Contracting Authority Trade-Marks shall be governed by the terms of the Trade-Mark Licence Agreement.

3.2 Licence by Project Co to Contracting Authority

- (a) Project Co hereby grants to Contracting Authority a Licence to:
 - (i) Use and Modify the Project Co Intellectual Property (excluding Project Co Licenced Software and Project Co Embedded Software) that is Delivered and the Subcontractor Intellectual Property (excluding the Subcontractor Licenced Software and the Subcontractor Embedded Software) that is Delivered;

- (ii) Use, and have Limited Modification Rights to, the Project Co Licenced Software that is Delivered and the Subcontractor Licenced Software that is Delivered and only in respect of the modules that are Delivered; and
- (iii) Use, and have Limited Modification Rights to, the Project Co Embedded Software and the Subcontractor Embedded Software as part of and for the Use of the Equipment in which such software is included, embedded or otherwise incorporated;

for the Permitted Purposes. Subject to Section 3.11, the Licences granted pursuant to this Section 3.2 in respect of Project Software and Embedded Software apply to only object code versions thereof and not the source code materials for any such Project Software or Embedded Software.

In addition and notwithstanding any other provision of this Schedule 24, Project Co hereby grants to Contracting Authority a Licence to Use and Modify any System Architecture and Look and Feel that is not owned by Contracting Authority pursuant to this Schedule 24, for the Expanded Purposes.

- (b) The Licence granted pursuant to this Section 3.2 will be irrevocable (except as provided in Section 3.2(d)), perpetual, royalty free, fully paid-up (upon payment of the fees specified in the Project Agreement for the Deliverable which consists of or incorporates the Licenced Intellectual Property in respect of which the Licence is granted), and permit Use by Contracting Authority on an enterprise basis without restriction or limitation as to users (whether by number, identity or otherwise), location, capacity, authorized system or otherwise, as part of or in connection with the System, or in the case of the System Architecture and Look and Feel, in connection with the Expanded Purposes.
- (c) The Licence granted pursuant to this Section 3.2 may be transferred, assigned, sublicenced and otherwise disposed of by Contracting Authority subject to and in accordance with Section 49.2 of the Project Agreement, provided that the Licence in respect of Project Co Embedded Software and Subcontractor Embedded Software may only be transferred together with the Equipment in which such software is included, embedded or otherwise incorporated.
- (d) The Licence granted pursuant to this Section 3.2 may not be terminated except in the event of the failure of the Licensee to pay the applicable fees as provided for in the Project Agreement for the specific Deliverable which consists of or incorporates the Licenced Intellectual Property, and such failure is not remedied by the Licensee within 60 days after notice by Project Co to the Licensee demanding that such failure be remedied, provided that any such termination shall apply only to the Licenced Intellectual Property to which such failure applied and not to any other Licenced Intellectual Property. Except as specifically provided in this Section 3.2(d), Project Co shall not be entitled to terminate or rescind the Licence granted under this Section 3.2, and if the Licensee commits any other breach of or default under this Schedule 24 or the Project Agreement, whether material or not and whether that breach or default is or is not capable of being remedied, Project Co's rights and remedies in respect of that breach or default shall be limited to such rights and remedies other than termination or rescission of the Licence granted under this Section 3.2 as may exist at law or in equity, it being acknowledged by Project Co that except as provided in this Section 3.2(d) the Licence granted under this Section 3.2 is perpetual and irrevocable. No breach of or default under this Schedule 24 by Contracting Authority shall constitute a repudiation of the Licence granted under this Section 3.2 by Contracting Authority.

- (e) The Licensee may provide and disclose the Licenced Intellectual Property to any employee, contractor, subcontractor, consultant, service provider, outsourcer or other person retained by the Licensee (including the Operator) in connection with the Permitted Purposes, except in respect of the System Architecture and Look and Feel in connection with the Expanded Purposes, and any such employee, contractor, subcontractor, service provider, outsourcer or other person may exercise all rights to Use and Modify the Licenced Intellectual Property as may be granted by the Licensee to such person within the scope of the Licence granted by Project Co to the Licensee pursuant to this Schedule 24, provided that the Licensee shall be responsible for anything done or failed to be done by any employee, contractor, subcontractor, service provider, outsourcer or other person to whom the Licensee provides and discloses the Licenced Intellectual Property, including a breach by any such person of Contracting Authority's obligations of confidentiality in respect of any Confidential Information that is or is part of Licenced Intellectual Property.
- (f) The Licensee may Use Project Software that is licenced pursuant to this Section 3.2 in multiple environments or instances, including for training, development, testing, staging, and disaster recovery and in a live, production or operating environment.
- (g) The Licensee may make copies of the Licenced Intellectual Property as may be reasonably necessary for Use and Modification of the Licenced Intellectual Property in accordance with the Licence granted pursuant to this Section 3.2 or otherwise this Schedule 24. All such copies shall be Owned by Owner of the original Licenced Intellectual Property and licenced to the Licensee pursuant to this Section 3.2. Except as permitted by this Schedule 24, the Licensee will not copy, Modify, disassemble, reverse engineer, decompile, translate or otherwise obtain or create the source code for any Project Co Intellectual Property, Project Co Licenced Software, Project Co Embedded Software, Subcontractor Intellectual Property, Subcontractor Licenced Software or Subcontractor Embedded Software.
- (h) The Licensee will not remove from any Licenced Intellectual Property any markings or notices with respect to the ownership thereof, copyright therein or the confidentiality thereof.
- (i) Where Contracting Authority has the right to Modify any Licenced Intellectual Property, Project Co shall ensure that all authors of such Licenced Intellectual Property have waived all moral rights that such authors may have therein in favour of Contracting Authority and its successors, assigns and licensees.

3.3 Licences with Subcontractors

- (a) Project Co will be responsible to obtain from each Subcontractor the right to grant the Licence under Section 3.2 in respect of the Subcontractor Intellectual Property.
- (b) Project Co will be responsible to obtain from each Subcontractor the right to Use and Modify the Subcontractor Intellectual Property to the extent necessary for Project Co to perform its obligations under the Project Agreement, on such terms as are not in breach of or conflict with the Project Agreement.
- (c) Project Co will be responsible to grant to each Subcontractor the right to Use and Modify Contracting Authority Intellectual Property and Project Co Intellectual Property to the extent necessary for each Subcontractor to perform its obligations under its Subcontract, on such terms as are not in breach of or conflict with the Project Agreement.

3.4 Third Party Intellectual Property: Project Co will not, and will not permit any Project Co Personnel, Subcontractor or Subcontractor Personnel to, incorporate, embed or otherwise include in the System or any Deliverable any Third Party Intellectual Property unless:

(a) for Third Party Intellectual Property other than Third Party Embedded Software, such Third Party Intellectual Property is provided by the Owner thereof pursuant to a licence agreement that:

(i) grants to the Licensee rights equivalent to or better than the rights granted under the Licence in Section 3.2, including being assignable in accordance with Section 3.2(c), and, where the Third Party Intellectual Property is software or includes software, provides for the maintenance and support of that software on terms acceptable to Contracting Authority; or

(ii) has been approved by Contracting Authority in writing, which approval may be given or refused by Contracting Authority in its absolute and unfettered discretion;

and such licence agreement, if not entered into with Contracting Authority directly, has been assigned or is freely assignable to Contracting Authority.

(b) for Third Party Embedded Software, either (i) such Third Party Embedded Software is embedded in Equipment and is not provided by the Owner thereof pursuant to a licence agreement, but may be used by Contracting Authority or any subsequent owner of the machine or equipment as part of and for the intended purposes of such machine or equipment upon the purchase thereof, or (ii) such Third Party Embedded Software is subject to a licence agreement that complies with Section 3.4(a).

(c) If Project Co, Project Co Personnel, Subcontractor or Subcontractor Personnel incorporates, embeds or includes any Third Party Intellectual Property in the System or any Deliverable other than in compliance with this Section 3.4, then in addition to any other rights and remedies Contracting Authority may have against Project Co, Project Co will at its sole cost and expense take all necessary steps to comply with this Section 3.4 or, if Project Co is unable to do so, to remove such Third Party Intellectual Property and replace it with Project Co Intellectual Property that provides the same functionality and performance as such Third Party Intellectual Property and which will operate within the System without any degradation thereof or adverse effect thereon, and which will be included in the Project Co Intellectual Property for the purposes of the Licence granted pursuant to Section 3.2.

3.5 Non-Assertion: Project Co agrees not to assert, and to cause its Subcontractors not to assert, any Intellectual Property right against Contracting Authority or any Licensee that would have the effect of diminishing the rights granted to Contracting Authority or any Licensee hereunder. Without limiting the generality of the foregoing, Project Co will not sue, and will cause its Subcontractors not to sue, Contracting Authority or any Licensee on the basis that any Equivalent Activity or the Ownership or Use of the System or any Deliverable within the scope of the Permitted Purposes infringes any Intellectual Property right of Project Co or any Subcontractor.

3.6 Deliveries: Project Co will deliver to Contracting Authority all Licenced Intellectual Property at the times specified in the Project Agreement, or where no time is specified, on or before the Final Completion Date or the Termination Date, whichever is first to occur. The media on which Project Software is delivered and tangible copies or embodiments of any Licenced Intellectual Property other than Project Software and will be the property of Contracting Authority, notwithstanding

Project Co's, a Subcontractor's or a third party's Ownership of the Licenced Intellectual Property. If any Licenced Intellectual Property requires software in order to Use that Licenced Intellectual Property, Project Co will ensure that such software will be commercially available to Contracting Authority at a reasonable licence fee, or if such software is not commercially available, Project Co will at its cost provide such software and a licence therefor to Contracting Authority and Contracting Authority Parties on terms and conditions that do not result in any impairment of Contracting Authority's Use of the Licenced Intellectual Property in accordance with the Licence therefor.

- 3.7 Pass Through Obligations:** Project Co is responsible to include in all contracts with Project Co Personnel and in all Subcontracts with Subcontractors such terms and conditions as may be necessary for Project Co to grant, or obtain for Contracting Authority, the Ownership, Licences, rights and benefits provided for in this Schedule 24.
- 3.8 Conflicting Software Licences:** All software referenced in this Schedule 24 will be licenced in accordance with this Schedule 24, and any form of software licence agreement used or provided by a licensor in association with any such software will be of no force or effect and will not be binding on Contracting Authority or any other Licensee, even if by its terms such software licence agreement is stated to be accepted by the installation or use of the software, and regardless of any acceptance of such software licence agreement that is required in order to install or use the software.
- 3.9 Trade-Marks and Names:** Except as expressly set forth: (a) in the Trade-Mark Licence Agreement; (b) the Project Agreement; or (c) otherwise in a writing executed by each of Contracting Authority and Project Co, neither Party shall use any Trade-Marks owned by the other Party, or use the names or any identifying logos or otherwise of the other Party in any advertising or permit them so to be used.
- 3.10 Open Source:** Project Co shall not, and shall cause the Subcontractor not to, incorporate, embed or include any Open Source Materials in any Deliverables, Contracting Authority Intellectual Property, Contracting Authority Supplied Third Party Intellectual Property without the prior written consent of Contracting Authority.
- 3.11 Escrow Agreements**
- (a) If requested by Contracting Authority (which for the purposes of this Section 3.11 includes any permitted assignee under Section 49.2 of the Project Agreement), at any time during the Project Term, Project Co will, or will require the applicable Subcontractor or third party licensor to, enter into an Escrow Agreement for any Software or Embedded Software (an "**Escrowed Deliverable**") on terms that comply with this Section 3.11, or amend its existing Escrow Agreement for such Software or Embedded Software to comply with this Section 3.11, and add Contracting Authority as a beneficiary under the Escrow Agreement.
- (b) The Escrow Provider will deposit with the Escrow Agent the Escrow Materials for the Escrowed Deliverable and all Modifications thereto provided by the Escrow Provider to Contracting Authority as part of the Works, Software Maintenance and Support (if purchased by or on behalf of Contracting Authority) or any other services performed by the Escrow Provider for Contracting Authority, and in the case of Software or the Embedded Software, the Escrow Provider will update the Escrow Materials to conform to the then-current version of the Software in use by Contracting Authority including all Modification thereto made for the benefit of Contracting Authority.

- (c) Contracting Authority will have the right, on reasonable notice to the Escrow Provider and the Escrow Agent, to verify that the Escrow Materials conform to the Escrowed Deliverable supplied to and in use by Contracting Authority to which the Escrow Materials relate. In addition, Contracting Authority may purchase such additional verification services as may be offered by the Escrow Agent and the Escrow Provider will cooperate with Contracting Authority and the Escrow Agent in the performance of those verification services.
- (d) Contracting Authority will have the right to obtain from the Escrow Agent a copy of the Escrow Materials upon any of the following events:
- (i) the Escrow Provider is bankrupt;
 - (ii) a trustee, receiver, manager, receiver-manager, custodian or person having similar authority is appointed for the Escrow Provider or its business and assets and is not released or removed within 30 days after the appointment;
 - (iii) the Escrow Provider seeks protection from its creditors or undertakes any reorganization for the purpose of obtaining relief from its creditors;
 - (iv) the Escrow Provider ceases to carry on business; or
 - (v) in the case of Software, if Contracting Authority is purchasing Software Maintenance and Support for the Software in respect of which the Escrow Materials have been deposited, if the Escrow Provider has given Contracting Authority or any of its representatives notice that it will no longer provide Software Maintenance and Support or if the Escrow Provider defaults in the performance of Software Maintenance and Support and does not remedy that default within 30 days after receipt of notice from Contracting Authority demanding that the Escrow Provider do so.
- (e) Project Co shall ensure that the Escrow Agreement: (i) requires the Escrow Agent to release the Escrow Materials to Contracting Authority if any of the events listed in Section 3.11(d) occur; (ii) does not contain any provision placing any obligation on Contracting Authority, including any indemnity obligation; and (iii) complies with and does not contradict any provision of this Section 3.11. Where this Section 3.11 places an obligation on the Escrow Agent, Project Co shall cause the Escrow Agent to comply with all such obligations.
- (f) Project Co hereby grants, and Project Co shall ensure that all Escrow Providers grant to Contracting Authority as of the date the applicable Software or the applicable Embedded Software is used in connection with the Project Scope, a Licence to:
- (i) Use the Escrow Materials to enable Contracting Authority to Use the Escrowed Deliverable to which the Escrow Materials relate for the Permitted Purposes, and where the Escrowed Deliverable is or contains Licenced Intellectual Property in accordance with the Licence applicable thereto;
 - (ii) make Modifications to the Escrow Materials notwithstanding any contradictory term or condition in the Licence applicable to the Escrow Materials which Modifications are only used for the Permitted Purposes or the Expanded Purposes, as applicable, and are subject to confidentiality obligations under Section 3.11(f)(v);

- (iii) recompile versions of the Software or Embedded Software from the Escrow Materials, which recompiled versions shall be deemed to form part of the Software or Embedded Software and be subject to the terms hereof;
 - (iv) make only those copies of the Escrow Materials that Contracting Authority reasonably requires for the purposes set out in Sections 3.11(f)(i), 3.11(f)(ii) and 3.11(f)(iii); and
 - (v) disclose the Escrow Materials, or any part thereof, only to agents, employees or contractors of Contracting Authority as reasonably required for the purposes set out in Sections 3.11(f)(i), 3.11(f)(ii) and 3.11(f)(iii), provided that such agents, employees and contractors are bound by obligations of confidentiality in respect of any Escrow Materials disclosed to them, the breach of which shall constitute a breach by Contracting Authority of its obligations of confidentiality in respect of the Escrow Materials.
- (g) The Licence granted pursuant to Section 3.11(f) will:
- (i) where the Escrow Provider is Project Co or a Subcontractor, form part of the Licence granted pursuant to Section 3.2; or
 - (ii) where the Escrow Provider is a third party, form part of the licence granted by such third party to Contracting Authority;
- and in either case remain in effect for so long as such licence remains in effect.
- (h) Except where Contracting Authority (i) terminates the Escrow Agreement, (ii) has a renewal right and fails to renew the Escrow Agreement, or (iii) fails to make payments as set out in Section 3.11(i), the Escrow Provider will not terminate or fail to renew the Escrow Agreement without entering into a new Escrow Agreement with a replacement escrow agent on terms and conditions substantially the same as the Escrow Agreement and this Section 3.11.
- (i) The Contracting Authority will pay all fees charged by the Escrow Agent in association with the deposit and maintenance of the Escrow Materials by the Escrow Agent under the Escrow Agreement for the benefit of Contracting Authority. The Escrow Provider shall have no responsibility or liability arising from any failure of Contracting Authority to pay fees when due in order to maintain the Escrow Materials with the Escrow Agent.
- (j) If Contracting Authority receives the Escrow Materials, then as between Contracting Authority and Project Co and notwithstanding any other provision of the Project Agreement, Contracting Authority will own all Modifications to the Escrow Materials made by or for Contracting Authority and all Intellectual Property in such Modifications.
- 3.12 Modifications:** Notwithstanding the granting of any licence pursuant to this Schedule 24, where Contracting Authority has made any Modification to the Project Co Intellectual Property or the Subcontractor Intellectual Property other than (a) a Modification made by or on behalf of Project Co or a Subcontractor or otherwise authorized by Project Co or any Subcontractor, or (b) a Modification made through the Limited Modification Rights,
- then,

- (i) any warranty provided by Project Co under the Project Agreement shall not apply solely in respect of such Modification;
- (ii) Project Co and the Subcontractors shall not be liable in respect of any Direct Losses arising in connection with such Modifications where such Modifications are the direct cause of such Direct Losses, and the Direct Losses would not have occurred but for the Modifications; and
- (iii) the indemnity obligations of Project Co set out in Section 46.1(f) of the Project Agreement shall not apply in respect of any such Modifications where the Modifications are the direct cause of such Direct Losses, and the Direct Losses would not have occurred but for the Modifications.

Appendix A

Form of Trade-Mark Licence Agreement

TRADE-MARK LICENCE AGREEMENT

THIS TRADE-MARK LICENCE AGREEMENT, effective as of [DATE] (the “**Agreement**”), is between Contracting Authority (the “**Licensor**”), and [•] (the “**Licensee**”), and Licensor and Licensee are referred to herein individually as a “**Party**” and collectively as the “**Parties**”.

WHEREAS:

1. Licensor and Licensee are parties to a Project Agreement dated [DATE] (the “**Project Agreement**”);
2. Capitalized terms used but not defined herein have the meanings assigned to them in the Project Agreement and this Schedule 24 thereto;
3. Licensor owns the trade-marks shown on Exhibit A (the “**Marks**”);
4. Licensee proposes to use the Marks in [Ontario] (the “**Territory**”) for the Limited Purpose set forth below; and
5. Subject to the terms and conditions set forth herein, Licensor is willing to grant to Licensee, and Licensee is willing to accept, a non-exclusive licence to use the Marks pursuant to the terms of this Agreement.

NOW THEREFORE in consideration of the covenants contained herein, the receipt and sufficiency of which are acknowledged, the Parties agree as follows:

1. **Grant:** Licensor grants to Licensee, and Licensee accepts, a limited, non-transferable, non-exclusive, royalty-free right and licence to use the Marks in the Territory for the sole purpose of and only to the extent necessary for the performance by Licensee of the Project Scope and its obligations under the Project Agreement (the “**Limited Purpose**”).
2. **No Right to Sublicence:** Licensee acknowledges and agrees that it does not have the right to sublicense the use of the Marks to any party without the express written consent of Licensor.
3. **Ownership:** Licensee acknowledges Licensor’s ownership of the Marks, and agrees that its use of the Marks shall enure to Licensor’s benefit.
4. **Licensee Covenants:** Licensee acknowledges that Licensor is the owner of all rights in the Marks, and, except as otherwise expressly permitted by this Agreement, Licensee shall not at any time do or suffer to be done any act or thing that will in any way impair the rights of Licensor in and to the Marks. Nothing in this Agreement grants, nor shall Licensee acquire, any right, title or interest in or to the Marks or any goodwill associated with the Marks, other than those rights expressly granted hereunder. Licensee shall affix to all materials that contain or bear one or more of the Marks such legends and notices as Licensor may reasonably require. At Licensor’s request, Licensee shall publish a public notice in the following form, or in any other form prescribed by Licensor from

- time to time, in appropriate publications addressed to the general public: “[MARK] is a trade-mark owned by [LICENSOR] used under licence by [LICENSEE]”. Licensee undertakes to comply with all relevant laws and regulations pertaining to trade-marks and marking requirements. Licensee shall execute all documents and provide all assistance reasonably required by Licensor to apply for, obtain and maintain registrations for the Marks, and to enforce rights in, and defend any proceedings brought against applications or registrations for, the Marks.
5. **Restrictions On Use:** Notwithstanding anything contained in this Agreement or otherwise, Licensee shall use the Marks only in accordance with the design, description and/or appearance of the Marks as shown on Exhibit A. Licensee may not change or modify the Marks nor join the mark with any other words or designs. Licensee agrees to abide by any reasonable guidelines provided by Licensor from time to time in connection with the use of the Marks.
 6. **Quality Standards and Control:** Licensee agrees that use of the Marks by Licensee in association with any products or services (the “**Products**” and “**Services**”) will meet or surpass the standards set by Licensor and conveyed to Licensee from time to time for the character and quality of such Products and Services.
 7. **Inspection:** At the request of the Licensor, the Licensee shall provide to Licensor for Licensor’s review, comment and approval samples of the any Products and sample copies of materials associated with the Products or Services or used to advertise/promote the Products or Services.
 8. **Breach of Licence:** Licensor may notify the Licensee if it objects to any proposed or actual use of the Marks if in Licensor’s sole judgment (acting reasonably) Licensor believes that the Marks is being used or proposed to be used in a manner that erodes the goodwill associated with the Marks or otherwise reduces the value of the Marks. If Licensee is so notified, the Parties shall attempt to settle any dispute and Licensee shall, if directed by Licensor to do so, cease using or cease from using the Marks until the time such dispute has been settled between the Parties or otherwise finally determined.
 9. **Infringement:** Licensee shall promptly notify Licensor upon becoming aware of any infringement or dilution of the Marks and shall cooperate fully with Licensor to stop such infringement or dilution. Licensor, in its sole discretion, will take any action that it deems necessary to protect the validity of the Marks, and Licensee hereby waives any rights that it may have pursuant to Section 50(3) of the Trade-marks Act.
 10. **Indemnification:** Licensor does not assume any liability to Licensee, or third parties, for Licensee’s goods or services, including the Products and Services, and Licensee shall defend, indemnify and hold harmless Licensor and its affiliates, successors and assigns, and their respective officers, directors, employees, agents, lawyers and representatives from and against any and all claims, causes of action, suits, damages, losses, liabilities, costs and expenses (including, but not limited to, reasonable lawyer fees and expenses), which may be sustained or suffered as a result of any such third party claims or arising from a breach of this Agreement by Licensee including any act or omission, which causes or is alleged to cause harm or a violation of any of the rights of any third party.
 11. **Breach/Use Outside Limited Purpose:** In the event that Licensee breaches any of the terms of this Agreement, including use of the Marks outside the Limited Purpose or Territory as determined by Licensor in its sole discretion, but acting reasonably, Licensor shall have the option to terminate

- this Agreement immediately, and if so terminated, all subsequent use by Licensee will be unauthorized and subject to legal action. Upon the termination of this Agreement for any reason, all rights in the Marks granted to Licensee hereunder shall automatically revert to Licensor, Licensee shall have no further rights in the Marks, and Licensee shall immediately change its use of the Marks to uses that do not consist of or include the Marks or any words similar to the Marks. In the event of an unauthorized use of the Marks by Licensee, Licensee consents to the immediate entry of a court injunction preventing Licensee's further use of the Marks.
12. **Termination:** This licence granted to Licensee will terminate upon the expiry or termination of Licensee's services and other obligations under the Project Agreement.
 13. **No Agency:** The Parties hereto are independent contractors with respect to each other, and nothing herein shall create any association, partnership, joint venture or agency relationship between them.
 14. **Assignment:** Licensee may not convey, sublicense, assign, transfer, pledge, hypothecate, encumber or otherwise dispose of this Agreement without the prior written consent of Licensor, which consent may be unreasonably withheld.
 15. **Headings:** The headings contained in this Agreement are for purposes of convenience only and shall not affect the meaning or interpretation of this Agreement.
 16. **Notices:** All notices, requests, demands and other communications made in connection with this Agreement shall be made in the manner set out in the Project Agreement.
 17. **Entire Agreement:** This Agreement constitutes the entire agreement between Licensor and Licensee with respect to the subject matter hereof and supersedes all prior agreements and understandings, whether oral, written, express or implied, between Licensor and Licensee.
 18. **No Waiver:**
 - (a) No waiver made or given by a Party under or in connection with this Agreement shall be binding or effective unless the waiver is in writing, signed by an authorized representative of the Party giving such waiver, and delivered by such Party to the other Party. No waiver made with respect to any right, power or remedy in one instance will be deemed to be a waiver with respect to any other instance involving the exercise of such right, power, or remedy or with respect to any other right, power, or remedy.
 - (b) Failure by either Party to exercise any of its rights, powers or remedies hereunder or its delay to do so shall not constitute a waiver of those rights, powers or remedies. The single or partial exercise of a right, power or remedy shall not prevent its subsequent exercise or the exercise of any other right, power or remedy.
 19. **Successors:** This Agreement shall be binding upon and shall enure to the benefit of the Parties and their respective successors and permitted assigns.
 20. **Severability:** Each provision of this Agreement shall be valid and enforceable to the fullest extent permitted by law. If any provision of this Agreement is declared invalid, unenforceable or illegal by the courts of a competent jurisdiction, such provision may be severed and such invalidity, unenforceability or illegality shall not prejudice or affect the validity, enforceability and legality of

the remaining provisions of this Agreement. If any such provision of this Agreement is invalid, unenforceable or illegal, the Parties shall, acting in good faith, promptly negotiate new provisions to eliminate such invalidity, unenforceability or illegality and to restore this Agreement as near as possible to its original intent and effect.

21. **Governing Law:** This Agreement shall be governed by and construed in accordance with the laws of the Province of Ontario and the laws of Canada applicable therein and shall be treated in all respects as an Ontario contract, without regard to conflict of laws principles. Each of the Parties attorn to the jurisdiction of the courts of the Province of Ontario and all courts competent to hear appeals therefrom.
22. **Counterparts:** The Project Agreement may be executed in one or more counterparts. Any single counterpart or a set of counterparts executed, in either case, by all the Parties shall constitute a full, original and binding agreement for all purposes. Counterparts may be executed either in original or faxed form provided that any Party providing its signature in faxed form shall promptly forward to the other Party an original signed copy of the Project Agreement which was so faxed.

[Remainder of page intentionally blank – Next page is the signature page.]

IN WITNESS WHEREOF, the Parties have signed this Agreement effective as of the date set forth above.

**ONTARIO INFRASTRUCTURE AND
LANDS CORPORATION, a Crown agent,
continued under the ONTARIO
INFRASTRUCTURE AND LANDS
CORPORATION ACT, 2011**

By: _____
Name:
Title:

By: _____
Name:
Title:

I/We have authority to bind the corporation.

METROLINX

By: _____
Name:
Title:

[LICENSEE]

By: _____
Name:
Title:

By: _____
Name:
Title:

I/We have authority to bind the corporation.

EXHIBIT A

Trade-marks

[Note to Completion: To be completed once trade-marks identified.]

SCHEDULE 25

INSURANCE AND PERFORMANCE SECURITY REQUIREMENTS

1. WORKS PHASE INSURANCE COVERAGE

1.1 Subject to Section 6, from and after execution of this Project Agreement and until the Substantial Completion Date, Project Co shall, at its own expense, obtain and maintain, or cause to be obtained and maintained, exclusively through the IO Construction Insurance Program (“**IOCI**P”) the following insurances as further described in Appendix A to this Schedule 25:

- (a) “All Risks” Course of Construction Property, including Boiler and Machinery;
- (b) “Wrap-Up” Commercial General Liability and Non-Owned Automobile Liability;
- (c) Project Specific Pollution Liability (combined Contractors’ Pollution Liability and Pollution Legal Liability); and
- (d) Project Specific Professional Liability.

1.2 Subject to Section 6, from and after execution of this Project Agreement and until the Substantial Completion Date, Project Co shall, at its own expense, obtain and maintain, or cause to be obtained and maintained, the following insurances as further described in Appendix A to this Schedule 25:

- (a) Automobile Liability;
- (b) Commercial General Liability and Non-Owned Automobile Liability (to be maintained by the Construction Contractor and each of the Subcontractors involved in the Works) with respect to off-Site/Lands operations and activities;
- (c) Aircraft and Watercraft Liability (if any exposure);
- (d) “All Risks” Marine Cargo (if any exposure);
- (e) “All Risks” Contractors’ Equipment;
- (f) Comprehensive Crime; and
- (g) WSIB.

2. NO LIMIT ON RECOVERY

2.1 Notwithstanding any other provision of this Project Agreement, it is hereby agreed that the limits of liability specified in this Schedule 25 for insurance policies, whether such policies are required to be obtained (or caused to be obtained) by Contracting Authority or by Project Co, shall in no way limit Project Co’s liability or obligations to Contracting Authority or Contracting Authority’s liability or obligations to Project Co, as applicable.

3. ADDITIONAL COVER

- 3.1 Without prejudice to the other provisions of this Schedule 25, Contracting Authority and Project Co shall, at all relevant times and at their own expense, obtain and maintain (or cause to be obtained and maintained) those insurances which they are required to obtain and maintain (or cause to be obtained and maintained) by Applicable Law, or that they consider necessary.
- 3.2 Contracting Authority reserves the right to require Project Co to purchase such additional insurance coverage as Contracting Authority may reasonably require. Contracting Authority also reserves the right to request such higher or lower limits of insurance or otherwise alter the types of coverage requirements, their minimum amounts and deductibles (taking into consideration such matters as the nature of the Works, contract value, industry standards and availability of insurance) as Contracting Authority may reasonably require from time to time. Any additional costs of such additional and/or amended insurance shall be borne by Contracting Authority and any cost savings resulting from the implementation of such additional and/or amended insurance shall be for the account of Contracting Authority.

4. RESPONSIBILITY FOR DEDUCTIBLES

- 4.1 The Party responsible for the matter giving rise to a claim, to the extent responsible therefor, shall be responsible and liable for the payment of deductibles under any policy of insurance under which it is an insured party or under any policy of insurance Project Co is required to maintain (or cause to be maintained) under this Schedule 25. In the event that responsibility for the matter giving rise to the claim is indeterminable, the First Named Insured under the policy of insurance is responsible and liable for the payment of deductibles.

5. COOPERATION WITH INSURER'S CONSULTANT

- 5.1 If an insurer or an insurer's appointed consultant, for underwriting purposes or as a term of an insurance policy, needs to review any part of the performance of this Project Agreement, then Contracting Authority and Project Co shall, and shall require the Contracting Authority Parties and the Project Co Parties, respectively, to:
- (a) cooperate with the insurer and its consultant, including providing them with such information and documentation as they may reasonably require; and
 - (b) allow the insurer and its consultant to attend meetings between Project Co and Contracting Authority (or, as applicable, and if reasonably required by the insurer, between Project Co and those engaged by or through Project Co).

6. UNINSURABLE RISKS

- 6.1 The term "**Uninsurable Risk**" means a risk, or any component of a risk, against which Project Co is required to insure pursuant to this Schedule 25 and for which, at any time after the date of this Project Agreement, either:
- (a) the insurance required pursuant to this Schedule 25 (including the terms and conditions specified for such insurance herein) is not available in relation to that risk:

- (i) where Applicable Laws require that the insurer be licenced in the Province of Ontario to insure such a risk, by insurers licenced in the Province of Ontario; or
 - (ii) where Applicable Laws do not require that the insurer be licenced in the Province of Ontario to insure such a risk, by any insurer otherwise permitted under the terms of the Project Agreement; or
- (b) the insurance premium payable or the terms and conditions for insuring that risk are such that the risk is not generally being insured against in the worldwide insurance market.

Project Co has the onus of demonstrating, to Contracting Authority's reasonable satisfaction that the foregoing definition applies to a particular risk.

- 6.2 Project Co shall notify Contracting Authority as soon as possible and, in any event, within 15 Business Days after becoming aware of same, that a risk, or any component of a risk, has become an Uninsurable Risk, and shall provide Contracting Authority with all relevant details in relation to such risk, including a copy of the relevant insurance policy.
- 6.3 Project Co and Contracting Authority shall, as soon as possible following the provision of the Notice referred to in Section 6.2, meet to discuss, in good faith, the appropriate means by which the Uninsurable Risk should be managed and, if Project Co and Contracting Authority are able to agree to alternative arrangements, the Uninsurable Risk shall be managed in accordance with such alternative arrangements.
- 6.4 In the event that Project Co and Contracting Authority, each acting in good faith, are unable to agree to alternative arrangements with respect to the management of an Uninsurable Risk within 15 Business Days following the expiry of the period referred to in Section 6.2, Contracting Authority may, in its absolute discretion, either:
- (a) elect to assume responsibility for the Uninsurable Risk and, in respect of the year in which the relevant risk becomes an Uninsurable Risk and every year thereafter, withhold, in equal instalments over the course of such year, from the payment or payments otherwise due to Project Co an amount equal to the annual premium (index linked) relating to the Uninsurable Risk as was current on the date immediately prior to the date on which the relevant risk became an Uninsurable Risk, in which case this Project Agreement shall continue in full force and effect; or
 - (b) terminate this Project Agreement in accordance with Section 38.2 of the Project Agreement as if such termination had occurred as a result of the Parties having failed to reach agreement in accordance with Section 38.2 of the Project Agreement following the occurrence of an event of Force Majeure, and, in accordance with the provisions of Schedule 23 – Compensation on Termination, pay to Project Co an amount equal to the Non-Default Termination Sum.
- 6.5 On the occurrence of an Uninsurable Risk, Contracting Authority may, in its absolute discretion, either:
- (a) pay to Project Co an amount equal to the insurance proceeds that would have been payable to Project Co in connection with such Uninsurable Risk had the relevant insurance

continued to be available, in which case this Project Agreement shall continue in full force and effect; or

- (b) terminate this Project Agreement in accordance with Section 38.2 of the Project Agreement as if such termination had occurred as a result of the Parties having failed to reach agreement in accordance with Section 38.2 of the Project Agreement following the occurrence of an event of Force Majeure, and, in accordance with the provisions of Schedule 23 – Compensation on Termination, pay to Project Co an amount equal to the Non-Default Termination Sum.

6.6 With respect to any Uninsurable Risk:

- (a) Project Co shall continue to approach the insurance market on a regular basis and, in any event, at intervals of not less than 180 days and use reasonable efforts to obtain (or cause to be obtained) insurance to cover as much or all of the Uninsurable Risk as can be insured in the available insurance market from time to time; and
- (b) Subject to Section 6.6(a), Project Co shall be relieved of its obligation to maintain (or cause to be maintained) insurance in respect of the Uninsurable Risk.

6.7 Where a risk which was previously an Uninsurable Risk ceases to be so, Project Co shall, at its own expense, obtain and maintain (or cause to be obtained and maintained) insurance in accordance with the requirements of this Schedule 25 in respect of the risk and the provisions of this Section 6 shall no longer apply to such risk.

7. TOTAL OR SUBSTANTIAL DESTRUCTION

7.1 In the event of damage to, or destruction of, all or substantially all of the New Metrolinx Infrastructure and the New Third Party Infrastructure for which there is coverage under an insurance policy, any insurance proceeds received by Project Co shall first be applied so as to ensure the performance by Project Co of its obligations under this Project Agreement, including, where appropriate, the reinstatement, restoration or replacement of the New Metrolinx Infrastructure, the New Third Party Infrastructure, or any other assets, materials or goods necessary or desirable for the carrying out of the Works, all in accordance with the terms of the Insurance Trust Agreement.

8. SUBCONTRACTORS

8.1 Project Co shall require that all Subcontractors are covered by, or obtain, the insurance described in this Schedule 25, provided that Project Co shall determine the applicable limits to be obtained for such insurance. Project Co shall be solely responsible and liable for any damages which Contracting Authority may suffer as a direct result of Project Co's failure to comply with the foregoing.

8.2 If Project Co receives notice that any Subcontractor employed by or through Project Co is not covered by any insurance required by this Schedule 25 to be obtained (or cause to be obtained) by Project Co, Project Co shall:

- (a) ensure that such insurance coverage is put in place;

- (b) remove the Subcontractor from the Lands and ensure that such Subcontractor does not perform any further part of the Works until after such insurance coverage is put in place; or
- (c) if the Subcontractor cannot be covered by a particular policy as required by this Schedule 25, replace the Subcontractor with a new Subcontractor who can obtain the required insurance coverage; it being acknowledged by Project Co that the requirements and restrictions set forth in the Project Agreement regarding new and replaced Subcontractors shall be complied with.

9. RENEWAL

9.1 Project Co shall provide to Contracting Authority, at least five Business Days prior to the expiry date of any policy of insurance required to be obtained (or cause to be obtained) by Project Co pursuant to this Schedule 25, evidence of the renewal of each such policy satisfactory to Contracting Authority, acting reasonably.

10. NAMED AND ADDITIONAL INSUREDS AND WAIVER OF SUBROGATION

10.1 All insurance provided by Project Co, shall:

- (a) include Project Co, Project Co Parties, Contracting Authority, Contracting Authority Parties, and the Municipality as Named Insureds to the extent specified in Appendix A of this Schedule 25;
- (b) include Contracting Authority, Contracting Authority Parties, Railway Company, the Lenders, Hedge providers (as defined in the Lending Agreements) and the Lenders' Agent and/or Her Majesty the Queen in right of Ontario, Her Ministers, agents, appointees and employees, as the case may be, as Additional Insureds, or loss payees to the extent of their respective insurable interests to the extent specified in Appendix A of this Schedule 25;
- (c) except with respect to the Project Specific Professional Liability, Automobile Liability, Comprehensive Crime and WSIB specified in Appendix A to this Schedule 25, contain a waiver of subrogation as against the Lenders, Hedge Providers (as defined in the Lending Agreements) and the Lenders' Agent, Contracting Authority, the Contracting Authority Parties and their respective shareholders, officials, directors, officers, employees, servants, consultants (other than design consultants) and agents;
- (d) contain a breach of warranty provision whereby a breach of a condition by Project Co will not eliminate or reduce coverage for any other insured; and
- (e) be primary insurance with respect to any similar coverage provided by any insurance obtained by or available to Contracting Authority or the Lenders without any right of contribution of any insurance carried by Contracting Authority or the Lenders.

11. CERTIFICATES OF INSURANCE AND CERTIFIED COPIES OF POLICIES

- 11.1 Prior to the execution of the Project Agreement, Project Co will provide Contracting Authority with certified copies of policies, confirming that the insurances specified in Section 1.1 have been obtained and are in full force and effect.
- 11.2 Prior to the execution of the Project Agreement, Project Co will provide Contracting Authority with certificates of insurance or certified copies of policies, confirming that the insurances specified in Section 1.2 have been obtained and are in full force and effect. If certificates of insurance are provided, certified copies of the entire contents of all relevant insurance policies will be subsequently provided to Contracting Authority no later than 90 days after execution of this Project Agreement.

12. FAILURE TO MEET INSURANCE REQUIREMENTS

- 12.1 If Project Co fails to obtain or maintain, or cause to be obtained and maintained, the insurance required by this Schedule 25, fails to furnish to Contracting Authority a certified copy of each policy required to be obtained by this Schedule 25 or if, after furnishing such certified copy, the policy lapses, is cancelled, or is materially altered, then Contracting Authority shall have the right, without obligation to do so, to obtain and maintain such insurance itself in the name of Project Co, and the cost thereof shall either, at Contracting Authority's option, be payable by Project Co to Contracting Authority on demand or be deducted by Contracting Authority from the next payment or payments otherwise due to Project Co.
- 12.2 If coverage under any insurance policy required to be obtained (or caused to be obtained) by Project Co should lapse, be terminated or be cancelled, then, if directed by Contracting Authority, all work by Project Co shall immediately cease until satisfactory evidence of renewal is produced.

13. MODIFICATION OR CANCELLATION OF POLICIES

- 13.1 Except as noted in Appendix A to this Schedule 25, all insurance provided by Project Co shall contain endorsements confirming that the policy will not be cancelled, adversely reduced, adversely materially altered or adversely materially amended without the insurer(s) giving at least 90 days prior written notice by registered mail, at the address specified, to Contracting Authority, the Lenders' Agent and IO. For greater certainty, the terms "adversely reduced", "adversely materially altered" and "adversely materially amended" as used in this provision shall mean any decrease or reduction in policy limits, aggregate limits or sub-limits (other than as a result of claims under the policy), any increase in any policy deductible or self-insured retention, any reduction in the policy coverage period, cancellation or suspension of coverage with respect to any insured parties from the time the policy was issued for that policy period, addition of any exclusions or restrictions from the time the policy was issued for that policy period and any reduction or restriction in the scope of coverage provided under the policy, in all cases when such adverse reduction, adverse material alteration or adverse material amendment is initiated by the insurer.
- 13.2 All insurance provided by Project Co shall contain endorsements confirming that, in the event of cancellation for non-payment of premium, the insurer(s) will give at least 15 days prior written notice by registered mail, at the address specified, to Contracting Authority and the Lenders' Agent.

13.3 With respect to insurances described in Section 1.1(a), (b) and (c), and Section 1.2(d), breach of any of the terms or conditions of the policies required to be provided by Project Co, or any negligence or wilful act or omission or false representation by an Insured under these policies, shall not invalidate the insurance with respect to Contracting Authority, the Lenders or any other Insured, but only to the extent that such breach is not known to these parties.

14. INSURERS

14.1 All policies of insurance to be obtained (or caused to be obtained) by Project Co in accordance with this Schedule 25 shall be issued by financially sound insurers acceptable to Contracting Authority and Lenders, acting reasonably, and, where required by statute, be licenced to insure such risk in the Province of Ontario.

14.2 To be eligible to provide insurance, an insurer must have the capacity to provide the particular insurance and shall have current ratings from time to time of either:

- (a) a Financial Strength Rating of not lower than “A-” for three out of the previous five years but not lower than “B” at any time during those five years, and a Financial Size Category not lower than VII, such ratings being those established by A.M. Best Company (Best); or
- (b) a Long-Term Financial Strength Rating of not lower than “A-” for three out of the past five years but not less than “BBB” at any time during those five years, a Short-Term Financial Strength Rating of not lower than “A-3” for three out of the previous five years and a Financial Enhancement Rating of not lower than “A-” for three out of the previous five years but not less than “BB+” at any time during those five years, such ratings being those established by Standard and Poor’s (S&P); or
- (c) if the insurer is not rated by Best or S&P, an insurer that is acceptable to Contracting Authority and Lenders, acting reasonably, with respect to the insurances required by this Schedule 25.

15. POLICY TERMS AND CONDITIONS

15.1 All policies of insurance to be obtained (or caused to be obtained) by Project Co in accordance with this Schedule 25 shall be in form and substance satisfactory to Contracting Authority, its insurance advisors and Lenders, acting reasonably.

15.2 To achieve the minimum limits for any type of insurance required under Appendix A to this Schedule 25, it is permissible to arrange the insurance under a single policy, or by a combination of primary, umbrella and/or excess policies.

16. FAILURE TO COMPLY

16.1 Neither failure to comply nor full compliance by Project Co with the insurance provisions of this Schedule 25 shall relieve Project Co of its liabilities and obligations under this Project Agreement.

17. PERFORMANCE SECURITY REQUIREMENTS

[REDACTED]

18. INSURANCE TRUST AGREEMENT

- 18.1 All losses under the “All Risks” Course of Construction Property Insurance policy, including Boiler & Machinery Insurance carried by Project Co prior to Substantial Completion of the Works which relate to equipment purchased or owned by Contracting Authority shall be payable solely to Contracting Authority and shall not be payable to the Account Trustee or distributed pursuant to the Insurance Trust Agreement.

**APPENDIX A
INSURANCE REQUIREMENTS**

Works Insurance – Regional Express Rail – Davenport Diamond Project

From execution of the Project Agreement until Substantial Completion

Insurances to be provided, or caused to be provided, by Project Co and arranged through the IOCIP program

Type	Amount	Maximum Deductible	Principal Cover	Estimated Premium
<p>“All Risks” Course of Construction Property Including Boiler and Machinery</p>	<p>Value declared to be equal to the estimated completed project value of the Works, including Property of Every Description and all other property supplied by Contracting Authority or Contracting Authority Parties for incorporation into the Works.</p> <p>Soft Costs \$[REDACTED] (representing [REDACTED]% of Recurring / Continuing Soft Costs)</p> <p>Extra and Expediting Expense (minimum \$[REDACTED] sub-limit)</p> <p>Principal Extensions:</p> <ul style="list-style-type: none"> • Replacement Cost Valuation (Property) • Most Recent Technology Replacement Cost Valuation (Equipment or Machinery) • Flood (to policy limit with annual aggregate) • Natural or man-made earth movement, including earthquake, landslide or subsidence (to policy limit with annual aggregate) 	<p>[REDACTED]% of loss value / \$[REDACTED] minimum Earthquake</p> <p>\$[REDACTED] Flood</p> <p>\$[REDACTED] Testing and Commissioning</p> <p>\$[REDACTED] All other losses</p> <p>48 hour waiting period applicable to Off Premises Services Service Interruption</p>	<p>“All Risks” Course of Construction Property Insurance covering the full insurable replacement cost of the Works including cold and hot testing / commissioning, of Boiler & Machinery equipment, including HVAC, Soft Costs, with no early occupancy restriction.</p> <p>This coverage shall be primary with respect to the Works without right of contribution of any insurance carried by Contracting Authority or the Lenders.</p>	

Type	Amount	Maximum Deductible	Principal Cover	Estimated Premium
	<ul style="list-style-type: none"> • Electronic Data Processing equipment and media, including data restoration and re-creation costs • Transit • Unnamed locations • Bylaws (with respect to Existing or Renovated Buildings) (minimum \$[REDACTED] sub-limit) • Debris Removal (minimum \$[REDACTED] sub-limit) • Off Premises Services (\$[REDACTED] sub-limit) • Professional Fees (minimum \$[REDACTED] sub-limit) • Fire Fighting Expenses (minimum \$[REDACTED] sub-limit) • Valuable Papers (minimum \$[REDACTED] sub-limit) • Accounts Receivable (minimum \$[REDACTED] sub-limit) • Defence Costs (subject to a \$[REDACTED] sub-limit) • Radioactive contamination caused by sudden and accidental release of radioactive isotopes (resulting from an accident to measuring, testing or medical equipment and subject to a \$[REDACTED] sub-limit) • Contamination Clean-up or Removal (minimum \$[REDACTED] sub-limit) • Ammonia Contamination (minimum \$[REDACTED] sub-limit) 			

Type	Amount	Maximum Deductible	Principal Cover	Estimated Premium
	<ul style="list-style-type: none"> • Civil Authority Access Interruption (8 weeks) • Prevention of Ingress/Egress (8 weeks) • Permission for Partial Occupancy prior to Substantial Completion • Cost of Carrying Project Financing (6 Months), included in Soft Costs coverage • Margin of Profit Extension for Contractors • Testing and Commissioning (120 day limitation each component) <p>Permitted Exclusions:</p> <ul style="list-style-type: none"> • Cyber risk • Mould, fungi and fungal derivatives • Faulty workmanship, materials construction, or design but resultant damage to be insured to a minimum DE4 standard • War risk • Terrorism • Nuclear or radioactive contamination, except re radioactive isotopes intended for scientific, medical, industrial or commercial use • Contractors' equipment • Sanctions Clause 			
<i>Comments</i>	<ul style="list-style-type: none"> • Named Insured includes Project Co, Lenders, Hedge Providers (as defined in the Lending Agreements) Lender's Agent, the Construction Contractor, subcontractors, sub-subcontractors, consultants, sub-consultants or Contracting Authority, as their respective interests may appear • No provision permitted allowing a coinsurance penalty • Insurance shall be primary without right of contribution of any other insurance carried by any Named Insured • Additional key extensions of coverage: <ul style="list-style-type: none"> – Underground services, temporary works involved in the Project such as scaffolding, hoarding, etc., Site preparation, including excavation and associated improvements, landscaping and property of others used in the Project 			

Type	Amount	Maximum Deductible	Principal Cover	Estimated Premium
	<ul style="list-style-type: none"> - Losses payable in accordance with the Insurance Trust Agreement - Waiver of subrogation against all Named and Unnamed Insureds, including but not limited to Project Co, Contracting Authority, the Construction Contractor, subcontractors, professional consultants (other than for their professional liability), Lenders, Lenders' Agent, as well as officers, directors and employees, servants, and agents of the foregoing - Frost or freezing to concrete – but only resultant damage from a peril not otherwise excluded - Liberalization Clause - Errors and Omissions - Breach of Conditions 			
Underwriters	Principal underwriters in compliance with Clause 14 of this Schedule 25.			

Works Insurance – Regional Express Rail – Davenport Diamond Project

From execution of the Project Agreement until Substantial Completion

Insurances to be provided, or caused to be provided, by Project Co and arranged through the IOCIP program

Type	Amount	Maximum Deductible(s)	Principal Cover	Estimated Premium
<p>“Wrap-Up” Commercial General Liability and Non-Owned Automobile Liability</p>	<p>\$(REDACTED) each occurrence, and in the aggregate with respect to Broad Form Products and Completed Operations</p> <p>Sub-limits:</p> <ul style="list-style-type: none"> • \$(REDACTED) Non-Owned Automobile Liability • \$(REDACTED) Sudden and Accidental Pollution and Hostile Fire Pollution Liability • \$(REDACTED) “All Risks” Tenants’ Legal Liability • \$(REDACTED) Prairie or Forest Fire Fighting Expenses • \$(REDACTED) Employee Benefits Administrative Errors and Omissions • \$(REDACTED) Contractors Rework • \$(REDACTED) Legal Liability for Damages To Non-owned Automobiles (SEF 94) • \$(REDACTED) Medical Payments <p>Principal Extensions:</p> <ul style="list-style-type: none"> • Owner’s and Contractor’s Protective • Blanket Contractual (written and oral) • Direct and Contingent Employers Liability 	<p>\$(REDACTED) per occurrence</p> <p>\$(REDACTED) per claim with respect to Contractors Rework</p> <p>\$(REDACTED) per claim with respect to each SEF 94, Tenants’ Legal Liability, Employee Benefits Administrative Errors and Omissions and Prairie or Forest Fire Fighting Expenses</p>	<p>“Wrap-Up” Commercial General Liability and Non-Owned Automobile Liability insurance covering all construction operations on an occurrence basis against claims for Bodily Injury (including Death), Personal Injury, Property Damage (including Loss of Use), and including Products and Completed Operations Liability extension for a period of not less than 24 months, effective from the date of Interim Completion and Substantial Completion, as applicable.</p> <p>Sudden and Accidental Pollution and Hostile Fire Pollution coverage to be not less than IBC 2313 form (240 hours detection/240 hours’ notice coverage structure).</p> <p>This coverage shall be primary with respect to the Works without right of contribution of any insurance carried by Contracting Authority or the Lenders</p>	

Type	Amount	Maximum Deductible(s)	Principal Cover	Estimated Premium
	<ul style="list-style-type: none"> • Employee Benefits Administrative Errors and Omissions • Personal Injury (nil participation) • Cross Liability and Severability of Interest with respect to each insured party • Blasting/demolition/excavating/underpinning/pile driving/shoring/caisson work/work below ground surface/tunnelling/grading, and similar operations associated with the Works, as applicable • Elevator and Hoist Collision Liability • Liberalized Notice of Claim Requirement, i.e., requirement to report will commence when knowledge is held by a designated project person(s) – to be identified by Project Co • Non-Owned Automobile Liability • Tenants’ Legal Liability (All Risks) – subject to sub-limit • Medical Expenses – subject to sub-limit • Prairie or Forest Fire Fighting Expenses – subject to sub-limit • Sudden and Accidental Pollution and Hostile Fire Pollution – subject to sub-limit • Permission for Unlicensed Vehicles (partial road use) • Unlicensed Equipment • Loss of Use Without Property Damage • Loading and Unloading of Automobiles • Broad Form Property Damage • Broad Form Completed Operations 			

Type	Amount	Maximum Deductible(s)	Principal Cover	Estimated Premium
	<ul style="list-style-type: none"> • Intentional Injury, committed to Protect Persons or Property • Accident Benefits • Limited UAV • Worldwide Territory, subject to suits being brought in Canada or the US <p>Permitted Exclusions:</p> <ul style="list-style-type: none"> • Injury to employees, where WSIB provides valid coverage • Property in the care, custody or control of the insured, except as provided under Broad Form Products and Completed Operations • Operation of licensed motor vehicles, other than attached machinery while used for its purpose, at the Lands • Physical damage to the Project, except during Broad Form Products and Completed Operations extension period • Cyber risk • Mould, fungi and fungal derivatives • Professional liability of engineers, architects, and other professional consultants • Nuclear or radioactive contamination, except release radioactive isotopes intended for scientific, medical, industrial or commercial use • Asbestos • Sanctions Clause 			
<i>Comments</i>	<ul style="list-style-type: none"> • Named Insured includes Project Co and its Affiliates, Contracting Authority, the Municipality, the Lenders, Hedge Providers (as defined in the Lending Agreements), Lenders' Agent, Project Co Parties involved in the Works, including the Construction Contractor, all subcontractors, sub-subcontractors, suppliers while working on the Lands, tradesmen while working on the Lands, engineers, architects, consultants and sub-consultants, (other than for 			

Type	Amount	Maximum Deductible(s)	Principal Cover	Estimated Premium
			professional liability), others as Additional Insureds, as may be required from time to time, arising from all operations and activities pertaining to the Works and the control and use of the Lands <ul style="list-style-type: none"> • Directors, officers, shareholders, employees of the insured parties involved in the Works covered as Additional Insureds • Railway Company covered as Additional Insured • Insurance shall be primary without right of contribution of any other insurance carried by any Named Insured • Aggregate limits will be permitted for Products and Completed Operations, Prairie and Forest Fire Fighting Expenses, Sudden and Accidental Pollution and Hostile Fire Pollution and Employee Benefits Administrative Errors & Omissions Liability; no policy general aggregate will be permitted • Professional service activities integral to the project, but not covering engineers, architects or other professional consultants, i.e., incidental professional liability risk of a Named Insured and their employed professionals is to be covered, but not the professional liability of independent fee-for-service professional consultants, architects or engineers • Waiver of subrogation of insurers' rights of recovery, against all Named and/or Additional Insureds, including Project Co, Contracting Authority, the Construction Contractor, subcontractors, sub-subcontractors, professional consultants, engineers, architects (other than for their professional liability), Lenders, Lenders' Agent, as well as officers, directors, employees, servants and agents of the foregoing 	
Underwriters	Principal underwriters in compliance with Clause 14 of this Schedule 25.			

Works Insurance – Regional Express Rail – Davenport Diamond Project

From execution of the Project Agreement until Substantial Completion

Insurances to be provided, or caused to be provided, by Project Co and arranged through the IOCIP program

Type	Amount	Maximum Deductible	Principal Cover	Estimated Premium
<p>Project Specific Pollution Liability (combined Contractors' Pollution Liability and Pollution Legal Liability): Combined Limit subject to Contractors' Pollution Legal Liability with a minimum \$[REDACTED] sub-limit</p>	<p>\$[REDACTED] per claim and in the aggregate for all claims, inclusive of defense and all costs and expenses</p> <p>Principal Extensions:</p> <ul style="list-style-type: none"> • Hazardous Substances occurring at or emanating from the Works or the Lands during the Policy Period • Microbial Matter (including Fungus/Mould) • Underground / above ground storage tanks • First Party Restoration and Clean-up Costs • Disposal Site Extension, including Transportation (reporting required) • Duty to Defend • Canada and US Territory • Contractual Liability • Emergency Response Costs <p>Permitted Exclusions:</p> <ul style="list-style-type: none"> • Terrorism • War • Intentional Non-compliance • Prior Knowledge • WSIB • Employers' Liability • Professional Liability • Nuclear Liability 	<p>\$[REDACTED] per claim inclusive of defense and all costs and expenses</p>	<p>Pollution Liability insurance covering third party bodily injury, property damage consequential loss or damage, including clean-up and restoration costs, both at the Lands and off-Site, as required.</p> <p>Extended Reporting Period: Minimum of 36 months after Interim Completion and Substantial Completion, as applicable.</p> <p>This coverage shall be primary with respect to the Works without right of contribution of any insurance carried by Contracting Authority or the Lenders.</p>	

Type	Amount	Maximum Deductible	Principal Cover	Estimated Premium
	<ul style="list-style-type: none"> Property Damage to Motor Vehicles during Transportation 			
<i>Comments</i>	<ul style="list-style-type: none"> Named Insured will include Project Co, its Affiliates, Project Co parties and all other parties engaged in the Works, including the Construction Contractor, subcontractors, sub-subcontractors, consultants and sub-consultants Contracting Authority, the Lenders, Hedge Providers (as defined in the Lending Agreements) and the Lenders' Agent will be identified as Additional Insureds or insured clients of Project Co and its Affiliates Waiver of subrogation in favour of Contracting Authority The directors, officers, shareholders, and employees of the foregoing shall be Additional Insureds 			
Underwriters	Principal underwriters in compliance with Clause 14 of this Schedule 25.			

Works Insurance – Regional Express Rail – Davenport Diamond Project

From execution of the Project Agreement until Substantial Completion

Insurances to be provided, or caused to be provided, by Project Co and arranged through the IOCIP program *continue here**

Type	Amount	Maximum Deductible	Principal Cover	Estimated Premium
<p>Project Specific Professional Liability</p>	<p> \$[REDACTED] minimum per claim / \$[REDACTED] in the aggregate (inclusive of defence and related costs and supplementary payments). Principal Extensions: <ul style="list-style-type: none"> • Primary insurance extension • Automatic addition of firms • Present, former partner, executive officer, director or shareholder of Named Insureds while acting within their scope of duties for the Named Insured • Any individuals or personal corporations retained by the Named Insured under a personal services contract • Claim defined as a written or oral demand for money or a written or oral allegation in breach in the rendering or failure to render professional services received by the Insured or Named Insured and resulting from a single error, omission or negligent act • Lawyer fees and associated expenses incurred in the investigation, defence, settlement, arbitration or litigation of claims • Duty to defend, even if the allegations are groundless, false or fraudulent • Worldwide Territory, subject to suits brought in Canada </p>	<p> \$[REDACTED] per claim, with respect to mitigation cover \$[REDACTED] per claim, all other claims </p>	<p> Project Specific Professional Liability Insurance in connection with the design and construction of the Works from beginning of first design, through the entire construction period, to Interim Completion and Substantial Completion, as applicable. plus coverage for an extended reporting period of not less than 36 months. This coverage shall be primary with respect to the Project without right of contribution of any insurance carried by Contracting Authority or the Lenders </p>	

Type	Amount	Maximum Deductible	Principal Cover	Estimated Premium
	<p>Permitted Exclusions:</p> <ul style="list-style-type: none"> • Express warranties or guarantees • Estimates on profit, return • Faulty workmanship, construction or work which is alleged or in fact not constructed in accordance with the design of the Project or the construction documents • Design or manufacture of any good or products sold or supplied by the Named Insured • Terrorism • Nuclear Liability • Judgments and awards deemed uninsurable by law • Liability assumed under design contract, unless such liability would have attached to the Named Insured by law in the absence of such agreement • Punitive or exemplary damages, fines, penalties or interest or liquidated - punitive or exemplary damages or fees • Refusal to employ, termination of employment, humiliation or discrimination on any basis or other employment related practices or policies • Sanctions Clause 			
<i>Comments</i>	<ul style="list-style-type: none"> • Named Insured: Construction Contractor (as applicable), all engineers, architects, and other professional consultants that provide professional design services in connection with the Project • Professional Services covered: All architectural, engineering, land surveying, environmental, landscape architectural, interior design/space planning, soil and material testing services, geotechnical services, and procurement services, including their replacements and/or sub-consultants of any tier • Retroactive Date: Full retroactive coverage from date of first design activity • Policy to be non-cancellable except for premium non-payment, material misrepresentation or concealment of facts, or a material breach of any condition of the policy 			
Underwriters	<ul style="list-style-type: none"> • Principal underwriters in compliance with Clause 14 of this Schedule 25. 			

Works Insurance – Regional Express Rail – Davenport Diamond Project

From execution of the Project Agreement until Substantial Completion

Insurances to be provided, or caused to be provided by Project Co

Type	Amount	Maximum Deductible	Principal Cover	Estimated Premium
<p>Automobile Liability</p>	<p>[\$REDACTED] (Minimum) for Project Co and Project Co’s Construction Contractor vehicles</p> <p>[\$REDACTED] (Minimum) for vehicles of any other subcontractors, sub-subcontractors, consultants, and sub-consultants, and workmen, tradesmen or other persons working on or at the Lands</p>		<p>Standard Ontario Owners Form for all vehicles operated by Project Co, the Construction Contractor, all subcontractors, sub-subcontractors, consultants and sub-consultants in connection with the Project.</p> <p>Business Automobile Liability insurance covering third party property damage and bodily injury liability (including accident benefits) arising out of any licensed vehicle.</p> <p>Policies shall be endorsed to preclude cancellation, except upon 60 days prior written notice provided to Contracting Authority and the Lenders.</p>	
<p>Commercial General Liability and Non-Owned Automobile Liability</p> <p>For Project Co, the Construction Contractor, all subcontractors, sub-subcontractors, consultants and sub-consultants, including Direct and Contingent Employers Liability, Products and Completed Operations Liability, and</p>	<p>[\$REDACTED] each occurrence, and in the annual aggregate with respect to Broad Form Products and Completed Operations for Project Co and Construction Contractor</p> <p>[\$REDACTED] each occurrence and in the annual aggregate with respect to Broad Form Completed Operations for any other contractor, subcontractors, sub-subcontractors, consultants and sub-consultants, workmen, tradesmen, or other persons involved in the Works</p> <p>In both instances, limits of liability may be structured as any combination of primary plus supplementary layers and Umbrella and/or Excess, or primary plus Umbrella and/or Excess</p>		<p>Commercial General Liability insurance covering all operations on an occurrence basis against claims for Bodily Injury (including Death), Broad Form Property Damage (including Loss of Use), and including Broad Form Products and Completed Operations Liability.</p> <p>This Commercial General Liability insurance will cover off-site activities connected to the Project and Products and Completed Operations Liability beyond the “Wrap-Up” Commercial General Liability Insurance policy’s Products and Completed Operations extension period.</p> <p>This insurance shall be maintained in effect during the Works phase until twelve (12) months following the earlier of the termination of the insured’s person’s involvement in the Works and the Substantial Completion Date.</p>	

Type	Amount	Maximum Deductible	Principal Cover	Estimated Premium
<p>Owner's and Contractor's Protective extensions</p>	<p>Sub-limits (Project Co and Construction Contractor):</p> <ul style="list-style-type: none"> • Full policy limits with respect to Non-Owned Automobile Liability • \$[REDACTED] Prairie or Forest Fire Fighting Expenses <p>Principal Extensions (required to be provided by the Project Co. and the Construction Contractor; shall be endeavoured to be provided by any other contractor, subcontractors, sub-subcontractors, consultants, sub-consultants, workmen, tradesmen or other persons involved in the Works):</p> <ul style="list-style-type: none"> • Owner's and Contractor's Protective • Blanket Contractual (written) • Direct and Contingent Employers Liability • Personal Injury (nil participation) • Cross Liability and Severability of Interest with respect to each insured party • Blasting/demolition/excavating/underpinning/pile driving/ shoring/caisson work/work below ground surface/tunnelling/grading, and similar operations associated with the Works as applicable • Elevator and Hoist Collision Liability • Non-Owned Automobile Liability • Prairie or Forest Fire Fighting Expenses - subject to sub-limit • Permission for Unlicensed Vehicles' (partial road use) • Unlicensed Equipment • Loss of Use Without Property Damage • Loading and Unloading of Automobiles • Broad Form Property Damage • Broad Form Completed Operations 		<p>Policies shall be endorsed to preclude cancellation, except upon 90 days prior written notice provided to Contracting Authority and the Lenders.</p>	

Type	Amount	Maximum Deductible	Principal Cover	Estimated Premium
	<ul style="list-style-type: none"> • Intentional Injury, committed to Protect Persons or Property • Worldwide Territory, subject to suits being brought in Canada or the US Permitted Exclusions: <ul style="list-style-type: none"> • Injury to employees, where WSIB provides valid coverage • Property in the care, custody or control of the insured, except as provided under Broad Form Products and Completed Operations • Operation of licensed motor vehicles, other than attached machinery while used for its purpose, or at the Lands • Cyber risk • Mould, fungi and fungal derivatives • Asbestos • Professional liability of engineers, architects, and other professional consultants • Nuclear or radioactive contamination, except release of radioactive isotopes intended for scientific, medical, industrial or commercial use • Sanctions Clause 			
<i>Comments</i>	<ul style="list-style-type: none"> • Contracting Authority, the Lenders, Hedge Providers (as defined in the Lending Agreement) and Lenders' Agent will be identified as Additional Insureds or insured clients of Project Co and its Affiliates 			
Aircraft and Watercraft Liability (If any exposure)	Minimum \$[REDACTED] inclusive, including \$[REDACTED] passenger hazard – Owned Aircraft Minimum \$[REDACTED] inclusive – Non-Owned Aircraft Minimum \$[REDACTED] inclusive Owned or Non-Owned Watercraft	To be determined	Policies shall be endorsed to preclude cancellation, except upon 90 days prior written notice provided to Contracting Authority and the Lenders.	

Type	Amount	Maximum Deductible	Principal Cover	Estimated Premium
<i>Comments</i>	<ul style="list-style-type: none"> Contracting Authority and the Lenders will be identified as Additional Insureds or insured clients of Project Co and its Affiliates 			
“All Risks” Ocean Marine Cargo (If any exposure)	[REDACTED]% Replacement Cost Valuation basis	[\$REDACTED]	Property of Every description destined for incorporation into the Works during marine transit, on a full replacement value basis, with no co-insurance provision. This coverage shall be primary with respect to the Works without right of contribution of any insurance carried by Contracting Authority or the Lenders.	
<i>Comments</i>	<ul style="list-style-type: none"> Named Insured includes Project Co, Lenders, Hedge Providers (as defined in the Lending Agreements), Lender’s Agent, the Construction Contractor, subcontractors, sub-subcontractors, consultants and sub-consultants and Contracting Authority, as their respective interests may appear. 			
“All Risks” Contractors’ Equipment	If Site equipment is three years old or less the sum insured shall be equal to [REDACTED]% of the replacement value of all contractors equipment used at the project. If Site equipment is more than three years old, actual cash value basis of loss settlement is acceptable.		“All Risks” coverage on all owned, rented, leased or borrowed contractors’ equipment used at the Lands.	
<i>Comments</i>	<ul style="list-style-type: none"> Waiver of subrogation rights against Project Co, Contracting Authority, the Construction Contractor, subcontractors, sub-subcontractors, consultants, sub-consultants, Lenders, Hedge Providers (as defined in the Lending Agreement), Lenders’ Agent as well as officers, directors, shareholders and employees of the foregoing 			
Comprehensive Crime	[\$REDACTED] per loss with respect to Employee Dishonesty		Employee Dishonesty insurance against the fraudulent/dishonest acts of employees of Project Co and Project Co Parties including additional coverage for Broad Form Money and Securities, Money Orders	

Type	Amount	Maximum Deductible	Principal Cover	Estimated Premium
			<p>and Counterfeit Paper, Depositors' Forgery, Computer Fraud and Funds Transfer Fraud, Audit Expenses and Credit Card Forgery.</p> <p>Custodial endorsement extending protection to third parties.</p> <p>Insurance primary without right of contribution of any other insurance carried by Contracting Authority or the Lenders.</p>	
<p>Underwriters (All non-IOCIP Works Phase insurances that are to be provided or caused to be provided by Project Co)</p>	<p>Principal underwriters in compliance with Clause 14 of this Schedule 25.</p>			
<p>WSIB</p>	<p>In accordance with Ontario Act's established benefits and schedules</p>	<p>Not Applicable</p>	<p>(i) Project Co and its Affiliates shall obtain and maintain at Project Co's expense, WSIB Insurance, in accordance with the Province of Ontario requirements.</p> <p>(ii) Project Co shall ensure that satisfactory evidence of WSIB Insurance is provided by all Project Co Parties, including all other consultants, sub consultants, contractors, subcontractors, suppliers and tradesmen working at the Lands</p>	
			<p>Prior to commencement of the work, each of the foregoing shall provide satisfactory written confirmation of compliance, from the appropriate authority, including confirmation that all required assessments have been paid to date.</p> <p>Upon Interim Completion and Substantial Completion of the Works, Project Co shall be provided with satisfactory written confirmation that all required assessments have been paid to date.</p>	

Type	Amount	Maximum Deductible	Principal Cover	Estimated Premium
			On request, within 30 days after such request, Project Co shall deliver to Contracting Authority evidence of the WSIB coverage maintained by any person involved in the Works, or confirmation of that person's exemption from WSIB coverage.	

**APPENDIX B
PERFORMANCE BOND**

**THIS BOND IS SUBJECT TO THE TERMS AND CONDITIONS OF
THE MULTIPLE OBLIGEE RIDER ATTACHED HERETO**

[REDACTED]

EXHIBIT 1 TO APPENDIX B

FORM OF MULTIPLE OBLIGEE RIDER TO PERFORMANCE BOND

[REDACTED]

**APPENDIX C TO SCHEDULE 25
FORM OF LABOUR AND MATERIAL PAYMENT BOND**

[REDACTED]

EXHIBIT 1 TO APPENDIX C

**LABOUR AND MATERIAL PAYMENT BOND
MULTIPLE OBLIGEE RIDER**

[REDACTED]

**SCHEDULE 26
RECORD PROVISIONS**

1. General Requirements

- 1.1 Project Co shall prepare, retain and maintain at its own expense, all the records (including superseded records) referred to in Section 2.1, as follows:
- (a) in accordance with this Section 1;
 - (b) in accordance with the Project Agreement;
 - (c) in accordance with the requirements of Good Industry Practice;
 - (d) having due regard to the guidelines and policies of the Office of the Information and Privacy Commissioner of Ontario;
 - (e) in accordance with the most stringent of Project Co's and the Construction Contractor's normal business practices;
 - (f) in accordance with Canadian GAAP;
 - (g) in chronological order;
 - (h) in electronic format in accordance with Contracting Authority's designated record keeping system;
 - (i) in sufficient detail, in appropriate categories and generally in such a manner as to enable Project Co to comply with Project Co's obligations under Section 28 of the Project Agreement; and
 - (j) in a form that is capable of audit.
- 1.2 Project Co shall retain and maintain all records at the New Metrolinx Infrastructure or otherwise on the Metrolinx Lands, in addition to retaining and maintaining records referred to in Section 2.1 in electronic format on Contracting Authority's designated record keeping system.
- 1.3 Wherever practical, original records shall be retained and maintained in a hard copy and electronic form. Project Co may retain true copies of original records where it is not practical to retain original records.
- 1.4 Any drawings (including the As Built Drawings) required to be made or supplied pursuant to the Project Agreement shall be on the most updated version of the applicable software and editable in updated base software format, and when printed, be of a size appropriate to show the detail to be depicted clearly without magnifying aids, shall be consistent in size and format to drawings previously submitted by Project Co to Contracting Authority, and shall conform to the Output Specifications, Good Industry Practice, and the CAD Standards. All drawings are to be submitted via Contracting Authority's electronic control management system, with one hard copy provided

- to Contracting Authority. Project Co shall make or supply drawings and other documents in such form as has been agreed by the Parties and shall include secure back up facilities. Contracting Authority shall provide Project Co access to Contracting Authority's electronic control management system.
- 1.5 Records shall be stored in electronic format within Contracting Authority's electronic control management system where Project Co shall have access thereto and will continue to have access thereto, such that Contracting Authority will be able to read, copy, download, and search same without licence or payment.
- 1.6 Subject to Sections 1.7 and 1.8, Project Co shall retain and maintain in safe storage, at its expense, all records referred to in Section 2.1 for a minimum period of at least seven years or such longer period as required by Applicable Law.
- 1.7 Project Co shall provide Notice to Contracting Authority if Project Co wishes to destroy any records referred to in this Schedule 26, or in respect of which the required period under Section 1.6 or under Applicable Law for their retention has expired. The Parties agree that:
- (a) within 60 days following such Notice, Contracting Authority may elect to require Project Co to deliver such records to Contracting Authority, in which case Project Co shall, at the expense of Contracting Authority, deliver such records (with the exception of Sensitive Information) to Contracting Authority in the manner and to the location as Contracting Authority shall specify; or
 - (b) if Contracting Authority fails to notify Project Co of its election pursuant to Section 1.7(a) within such 60 day period, Project Co may, at its expense, destroy such records.
- 1.8 In the event of termination of the Project Agreement in accordance with its terms, Project Co shall deliver all records that Project Co retains and maintains pursuant to this Schedule 26 to Contracting Authority in the manner and to the location that Contracting Authority shall reasonably specify. Contracting Authority shall make available to Project Co all the records Project Co delivers pursuant to this Section 1.8 subject to prior reasonable Notice. Project Co may deliver true copies of original records required by:
- (a) statute to remain with Project Co;
 - (b) Project Co in connection with its fulfilment of any outstanding obligations under the Project Agreement; or
 - (c) Project Co in connection with its fulfilment of any outstanding obligations under the Lending Agreements.
- 1.9 Where the termination of the Project Agreement arises:
- (a) as a result of an Contracting Authority Event of Default or pursuant to Section 38.3 of the Project Agreement, then the costs of delivering the records and the costs for retaining such records in safe storage will be borne by Contracting Authority; or

- (b) for any other cause, then the costs of delivering the records and the costs for retaining such records in safe storage for a period of at least six years following the Termination Date (unless a longer period is required by Applicable Law), shall be borne by Project Co.
- 1.10 Within 30 days after the end of each year or partial year of the Project Term, Project Co shall deliver to Contracting Authority a report, as reasonably requested by Contracting Authority in connection with Contracting Authority's financial reporting, detailing to the best of Project Co's knowledge at the time of any such report any and all liabilities, claims and demands, including contingent liabilities, claims and demands, that Project Co has or may have against Contracting Authority or that may be owing by Contracting Authority to Project Co. The Parties acknowledge and agree that the contents of any such report or the failure to mention any matter in any such report shall not limit either Party's rights or remedies against the other Party as contemplated by the Project Agreement.
- 1.11 Project Co shall provide to Contracting Authority:
- (a) not later than 60 days after the end of the first three fiscal quarters of Project Co in each fiscal year, part or all of which falls in a year of the Project Term, a copy of Project Co's unaudited financial statements in respect of that period, including an unaudited balance sheet and an unaudited statement of income, all prepared in accordance with GAAP (as defined in the Lending Agreements), and
- (b) not later than 120 days after the end of each fiscal year, a copy of Project Co's annual audited financial statements, in respect of that period, prepared in accordance with Applicable Law and GAAP (as defined in the Lending Agreements), together with a certificate of the auditors of Project Co setting forth that they have examined such statements and have conducted a general review of accounting procedures and such tests of accounting records and other supporting evidence as they consider necessary or advisable and confirming that in their opinion such statements present fairly the financial position of Project Co and the results of its operations for the fiscal year reported on and have been defined in accordance with GAAP (as defined in the Lending Agreements),

all of which documents, whether or not marked or identified as confidential or proprietary but subject to the exceptions contained in Section 42 of the Project Agreement, shall be treated by Contracting Authority as Confidential Information of Project Co.

2. Records To Be Kept

- 2.1 Without limiting any other requirement of the Project Agreement, Project Co shall prepare, retain and maintain at its own expense:
- (a) the Project Agreement, its Schedules and the Ancillary Documents, including all amendments to such agreements;
- (b) all records relating to the appointment and replacement of the Contracting Authority Representative and the Project Co Representative;
- (c) any documents, drawings (including the As Built Drawings) or submissions in accordance with Schedule 10 - Review Procedure;

- (d) any documents relating to Development Approvals and other Project Co Permits, Licences, Approvals and Agreements, including any refusals and appeals relating to any applications;
- (e) a complete record of construction, including:
 - (i) Access Management Plan and all sub-plans;
 - (ii) Works progress photography;
 - (iii) construction notices or other communications with adjacent businesses, property owners or tenants;
 - (iv) planned an unplanned interruptions of Utility Infrastructure;
 - (v) a complaints log including responses and any corrective action; and
 - (vi) any other items as requested by Contracting Authority from time to time.
- (f) all records relating to any statutory inspections of the New Metrolinx Infrastructure or the Metrolinx Lands, including any roadways and tracks;
- (g) any notices, reports, results and certificates relating to any Interim Completion, Substantial Completion, Final Completion, Interim Project Co Commissioning and Project Co Commissioning;
- (h) all operation and maintenance manuals;
- (i) any documents relating to events of Force Majeure, Delay Events, Compensation Events and Relief Events;
- (j) all documents submitted in accordance with Schedule 22 - Variation Procedure;
- (k) any documents related to decisions resulting from the Dispute Resolution Procedure;
- (l) any documents related to a Project Co Change in Ownership or Change in Control;
- (m) any documents relating to any Refinancing;
- (n) all accounts for Taxes and transactions relating to Taxes, including in relation to HST applicable to the Project, but excluding any records for:
 - (i) Project Co's liabilities or payments under the Income Tax Act (Canada), the Income Tax Act (Ontario) or any similar statute in any other jurisdiction;
 - (ii) Project Co's liabilities or payments for capital taxes based on or measured by the capital of Project Co;
 - (iii) the withholdings of any payments by Project Co; or

- (iv) any business or activity in addition to the business or activities related to, and conducted for, the purpose of the Project;
 - (o) the financial accounts of Project Co referred to in Section 1.11;
 - (p) all records required by Applicable Law (including in relation to health and safety matters) to be maintained by Project Co with respect to the Works;
 - (q) any documents relating to insurance and insurance claims;
 - (r) all Jointly Developed Materials; and
 - (s) all other records, documents, information, notices or certificates expressly required to be produced or maintained by Project Co pursuant to the Project Agreement.
- 2.2 Either Party may review the documents required to be prepared, retained and maintained by Project Co pursuant to Section 2.1.

SCHEDULE 27

DISPUTE RESOLUTION PROCEDURE

1. General

- 1.1 All disputes, controversies, or claims arising out of or relating to any provision of the Project Agreement, or the alleged wrongful exercise or failure to exercise by a Party of a discretion or power given to that Party under the Project Agreement, or the interpretation, enforceability, performance, breach, termination, or validity of the Project Agreement, including this Schedule 27, or any matter referred to for resolution pursuant to this Schedule 27 (collectively and individually, a “**Dispute**”) shall be resolved in accordance with the provisions of this Schedule 27.
- 1.2 The Parties agree that at all times, both during and after the Project Term, each of them will make bona fide efforts to:
- (a) resolve by amicable negotiations any and all Disputes arising between them on a without prejudice basis; and
 - (b) have all Disputes resolved at the lowest level of management before engaging the dispute resolution processes described in Articles 2 to 8 of this Schedule 27.
- 1.3 If the Parties are unable to resolve a Dispute at the lowest level of management pursuant to Section 1.2(b) of this Schedule 27, either Party may deliver to the Contracting Authority Representative or the Project Co Representative, as applicable, a written Notice of dispute (the “**Notice of Dispute**”), which Notice of Dispute shall, subject to the terms of this Schedule 27 requiring resolution of a Dispute pursuant to a specific dispute resolution process set forth in this Schedule 27, initiate the dispute resolution process described in Articles 2 to 8 of this Schedule 27, as applicable, as more particularly described in this Schedule 27. To be effective, the Notice of Dispute must expressly state that it is a Notice of Dispute, set out the particulars of the matter in dispute, describe the remedy or resolution sought by the Party issuing the Notice of Dispute and be signed by the Contracting Authority Representative, if given by Contracting Authority, or by the Project Co Representative, if given by Project Co.

2. Amicable Resolution by Party Representatives

- 2.1 On receipt of a Notice of Dispute, the Contracting Authority Representative and the Project Co Representative (collectively “**Party Representatives**” and individually “**Party Representative**”) shall each promptly and diligently make all reasonable bona fide efforts to resolve the Dispute. Each Party Representative shall provide to the other, on a without prejudice basis, frank, candid and timely disclosure of relevant facts, information and documents (except such documentation that is subject to legal privilege) as may be required or reasonably requested by the other to facilitate the resolution of the Dispute.

3. Amicable Resolution by Senior Officers of each Party

- 3.1 If, following the process referred to in Article 2 of this Schedule 27 (or as otherwise agreed to in writing by the Parties pursuant to Section 11.6 of this Schedule 27), a Dispute is not resolved by the Party Representatives within 10 Business Days after receipt by a Party of the applicable Notice

of Dispute, or within such longer period of time as the Party Representatives may both expressly agree, then at any time after the expiry of such period of time either Party Representative may, by Notice in writing to the other, refer the Dispute to an executive of a Party who:

- (a) is in a position of authority above that of the Contracting Authority Representative or the Project Co Representative, as the case may be; and
- (b) subject only to approval of the board of directors or similar governing body of the Party, has full authority to resolve and settle the Dispute.

3.2 Once a Dispute is referred to them, the executive of each Party shall promptly and diligently make all reasonable bona fide efforts to resolve the Dispute. All discussions and negotiations, and all documents exchanged, between them related to the Dispute shall be on a without prejudice basis to facilitate the resolution of the Dispute.

4. Independent Certifier

4.1 This Article 4 applies to all Disputes that fall within the description of Section 4.2 of this Schedule 27 that cannot be resolved as provided in Articles 2 and 3 of this Schedule 27 or as otherwise agreed to in writing by the Parties pursuant to Section 11.6 of this Schedule 27.

4.2 All Disputes related to the Works and that:

- (a) arise prior to, or otherwise in relation to any Interim Completion or Substantial Completion;
- (b) relate to completion of Interim Minor Deficiencies or Minor Deficiencies;
- (c) relate to whether any proposed work constitutes a Variation;
- (d) relate to a review of Estimates or any other matters relating to Variations as the Independent Certifier is entitled to review and determine pursuant to Section 31 of the Project Agreement;
- (e) are referred to in the Project Agreement for determination by the Independent Certifier; or
- (f) relate to the Certification Services or any Certification Service Variations (as those terms are defined in the Independent Certifier Agreement);

shall initially be submitted to the Independent Certifier for independent determination by the Independent Certifier within such period as may be specified in the Project Agreement, or if no period is specified, within 10 Business Days after submission to the Independent Certifier.

4.3 Without limiting any obligations of the Parties under the Independent Certifier Agreement, the Parties shall cooperate with the Independent Certifier and provide such information, records and documents as may be required by the Independent Certifier to make the determination within the period referred to in Section 4.2 of this Schedule 27.

- 4.4 The Independent Certifier’s decision to issue or not to issue the Interim Completion Certificate and the Substantial Completion Certificate shall be final and binding on the Parties solely in respect of determining the Interim Completion Payment Date and the Substantial Completion Payment Date, as applicable, and a Dispute in relation to the Interim Completion Payment Date or the Substantial Completion Payment Date, as applicable, shall not be subject to resolution pursuant to this Schedule 27.

Save and except as aforesaid, the Independent Certifier’s determinations are not binding on the Parties, and all Disputes in relation to the Independent Certifier’s decisions shall be resolved pursuant to this Schedule 27, provided however that Section 5 of this Schedule 27 shall not apply unless otherwise agreed by the Parties on terms acceptable to the Parties.

5. Adjudication

- 5.1 If the Parties fail to resolve any Dispute through the process referred to in Section 2 and 3 of this Schedule 27 within 15 Business Days following referral of the Dispute to an executive in accordance with Section 3.1 (or such other period as may be agreed or expressly stipulated in respect of the relevant matter) and it is not a Dispute referred to in Section 4.2 of this Schedule 27 or a Dispute referred to arbitration or litigation pursuant to Section 4.4 of this Schedule 27 (except as otherwise agreed to in writing by the Parties pursuant to Section 11.6 of this Schedule 27), either Party may refer the Dispute to an adjudicator selected in accordance with Section 5.2 of this Schedule 27 (the “**Adjudicator**”).

- 5.2 The Adjudicator nominated by the Party issuing the Notice of Dispute shall be agreed between the Parties or, failing agreement, shall be determined by the Ontario Superior Court of Justice (following an application thereto by the Party issuing the Notice of Dispute) pursuant to the *Arbitration Act, 1991* (Ontario) as if the adjudicator was an arbitrator under the *Arbitration Act, 1991* (Ontario) and shall:

- (a) be independent of and at arm’s length to Project Co, Contracting Authority, any Government Entity, the Lenders and any other person having an interest in the New Metrolinx Infrastructure and/or New Third Party Infrastructure or any of the Project Documents;
- (b) if the Dispute arises during the Project Term, be familiar with the construction of facilities and infrastructure similar to those included in this Project; and
- (c) be a person who has the qualifications and experience with respect to the particular issues in Dispute, including, where the issues in Dispute include whether Project Co has or will adversely impact the Contracting Authority Activities, then such qualifications and experience should include relevant experience in the provision of activities similar to the Contracting Authority Activities.

- 5.3 The Adjudicator shall resolve the Dispute in accordance with the United Kingdom Construction Industry Council’s *Model Adjudication Procedure; Fourth Edition* (the “**Model Adjudication Procedure**”) the terms of which are incorporated herein by reference, subject to the following modifications:

- (a) notwithstanding paragraph 14 of the Model Adjudication Procedure, within seven Business Days following appointment in relation to a particular Dispute, the Adjudicator shall require the Parties to submit in writing their respective arguments; provided that, where necessary, the onus of proving that the New Metrolinx Infrastructure and/or the New Third Party Infrastructure is operating in accordance with all relevant specifications and requirements set forth in the Project Agreement is on Project Co. The Adjudicator shall, in his absolute discretion, determine the procedure of the adjudication proceedings including whether a hearing is necessary in order to resolve the Dispute;
- (b) notwithstanding paragraphs 16 and 24 of the Model Adjudication Procedure, in any event, and subject to Section 5.4 of this Schedule 27, the Adjudicator shall provide to both Parties his written decision on the Dispute, within 10 Business Days following appointment (or within such other period as the Parties may agree after the reference). The Adjudicator shall give detailed reasons for the Adjudicator's decision. The Adjudicator shall be entitled to award compensation to a Party and shall be entitled to state the relief for such Party, which may include deeming the occurrence of any Relief Event, Delay Event and/or Compensation Event. Unless otherwise provided for in this Schedule 27, the Adjudicator's decision shall be binding on the Parties, but not final.
- (c) notwithstanding paragraphs 29 and 30 of the Model Adjudication Procedure, the Adjudicator's costs, including any legal fees, of any reference shall be borne as the Adjudicator shall specify or in default, equally by the Parties. In no circumstances shall the Adjudicator be entitled to order a successful or partially successful Party in an adjudication to pay more than one half of the Adjudicator's fees. Each Party shall bear its own costs arising out of the reference, including legal costs and the costs and expenses of any witnesses.
- (d) the Adjudicator shall be deemed not to be an arbitrator but shall render his decision as an expert and the provisions of the *Arbitration Act, 1991* (Ontario) and the law relating to arbitration shall not apply to the Adjudicator (other than as set out in Section 5.2 of this Schedule 27) or his determination or the procedure by which he reached his determination;
- (e) notwithstanding paragraph 26 of the Model Adjudication Procedure, the Adjudicator shall act impartially and may take the initiative in ascertaining the facts and the law. Unless otherwise expressly provided in the Project Agreement, the Adjudicator shall have the power to open up, review and revise any opinion, certificate, instruction, determination or decision of whatever nature given under the Project Agreement. For greater certainty, the Independent Certifier's decision to issue or not to issue the Interim Completion Certificate and the Substantial Completion Certificate shall be final and binding solely in respect of determining the Interim Substantial Completion Date and the Substantial Completion Payment Date, as applicable, and a Dispute in relation to the Interim Completion Payment Date and Substantial Completion Payment Date, as applicable, shall not be subject to resolution pursuant to this Schedule 27;
- (f) the Adjudicator shall execute a non-disclosure agreement (the "**Non-Disclosure Agreement**") in a form satisfactory to the Parties, providing that, among other things, all information, data and documentation disclosed or delivered by a Party to the Adjudicator in consequence of or in connection with his appointment as the Adjudicator shall be treated as confidential and without prejudice to any potential litigation proceedings. The

Adjudicator shall not, save except as expressly permitted by the Non-Disclosure Agreement, disclose to any person any such information, data or documentation, and all such information, data or documentation shall remain the property of the Party disclosing or delivering the same and all copies shall be returned to such Party on completion of the Adjudicator's mandate with respect to the Dispute; and

- (g) notwithstanding paragraph 34 of the Model Adjudication Procedure, the Adjudicator shall not be liable for anything done or omitted to be done in the discharge or purported discharge of his functions as Adjudicator unless the act or omission is in bad faith. Any employee or agent of the Adjudicator is similarly protected from liability.

5.4 Where it is determined by the Adjudicator that:

- (a) corrective measures must be taken by Project Co to resolve a Dispute, those measures must be implemented by Project Co as soon as reasonably practical, without payment by Contracting Authority unless (i) the Adjudicator determines otherwise; or (ii) that determination is subsequently reversed by a binding and final determination made in a court proceeding;
- (b) corrective measures are not required to be taken by Project Co to resolve a Dispute, Contracting Authority may, at its option, require corrective measures to be taken forthwith by Project Co, in which case those measures must be implemented by Project Co as soon as reasonably practical provided that Contracting Authority undertakes to pay Project Co for Direct Costs, plus reasonable overhead and profit incurred by Project Co as such costs are so incurred; provided that no such costs should exceed the amount Project Co is entitled to receive pursuant to Schedule 22 – Variation Procedure thereby incurred upon completion of those corrective measures, but any such undertaking and payment shall be without prejudice to Contracting Authority's right to contest the determination made by the Adjudicator in a subsequent proceeding. Contracting Authority shall provide Project Co such reasonable extensions of time in respect of Project Co's obligations under the Project Agreement necessary to allow Project Co to effect the corrective measures and such extension of time may be treated as a Delay Event, if so determined by the Adjudicator.

5.5 Subject to a right to require the Dispute to be arbitrated or litigated pursuant to Sections 6, 7 and 8 of this Schedule 27 by giving the required Notices to arbitrate or litigate within the time periods specified therein, the Parties agree that the Adjudicator's determination is final and binding and not subject to appeal, arbitration, litigation or any other dispute resolution process, and both Parties expressly waive all rights of appeal in connection with the Adjudicator's determination.

6. Referral of Disputes to Arbitration or Litigation

6.1 If:

- (a) the amount awarded by the Adjudicator pursuant to Section 5 of this Schedule 27 is more than \$[REDACTED] (index linked) in the aggregate or \$[REDACTED] (index linked) in any one year,
- (b) the Dispute involves issues other than monetary claims by one Party against the other Party and which a Party reasonably believes are material and significant to that Party, or

- (c) a Notice of Dispute has been issued for a Dispute in relation to the Independent Certifier's decisions for which Section 4.4 of this Schedule 27 provides that Section 5 of this Schedule 27 shall not apply to resolve such Dispute,

then, subject to the right of a Party to require litigation of the Dispute pursuant to Section 8.1 of this Schedule 27 or a consolidation of proceedings pursuant to Section 9 of this Schedule 27, either Party may, by written Notice signed by their Party Representative, request that the Dispute be resolved by arbitration pursuant to Section 7 of this Schedule 27 upon the written consent of the other Party. Such Notice will not be effective unless it indicates it is a Notice to arbitrate, is signed by the Party Representative and is delivered to the other Party Representative within 15 Business Days after receipt of the Adjudicator's decision or the Notice of Dispute referred to in Section 6.1(c) of this Schedule 27, as applicable, and provided further that such Notice expressly identifies the specific Dispute and decision of the Adjudicator or the Independent Certifier, as applicable, that is to be the subject of the arbitration.

- 6.2 If a Party is entitled to refer a Dispute to which Section 5 of this Schedule 27 applies to arbitration or litigation pursuant to Sections 6.1 or 8.1 of this Schedule 27 then, unless the Parties otherwise expressly agree in writing, all information, documents and submissions prepared by a Party for the Adjudicator which are not business records that would otherwise be kept in the normal course of business by the Party for its business purposes, and all decisions and determinations by the Adjudicator, shall be confidential and inadmissible in any arbitration or litigation proceeding. For greater certainty, the Adjudicator shall not be called as a witness by either party in any arbitration or litigation proceeding.

7. Resolution by Arbitration

- 7.1 Upon the mutual written consent of the Parties,

- (a) where the Parties fail to resolve a Dispute through the process set out in Sections 2, 3, 4 and 5 (to the extent required) of this Schedule 27, and
- (b) all other requirements set out in this Schedule 27 have been satisfied,

such Dispute may be referred to arbitration in accordance with the *Arbitration Act, 1991* (Ontario) and this Section 7.

- 7.2 Disputes referred to arbitration shall be resolved by a single arbitrator unless one of the Parties, by Notice in writing delivered to the other Party within five Business Days after a Notice to arbitrate pursuant to Section 6.1 of this Schedule 27 has been delivered, expressly requires that the Dispute that is the subject of that Notice to arbitrate be resolved by a three person arbitration tribunal, in which case that particular Dispute shall be resolved by a three person arbitration tribunal.

- 7.3 If the arbitration tribunal is comprised of a single arbitrator, the arbitrator shall be appointed as follows:

- (a) if the Parties agree on the arbitrator, the Parties shall jointly appoint the arbitrator as soon as possible and in any event within five Business Days after delivery of the Notice to arbitrate pursuant to Section 6 of this Schedule 27; and

- (b) if the Parties fail to agree or jointly appoint the arbitrator within such five Business Day period, either Party may apply to the Ontario Superior Court of Justice for appointment of the arbitrator, in which case the court shall appoint the arbitrator at the earliest opportunity in accordance with the following:
 - (i) from the lists of potential arbitrators submitted to the court by the Parties, provided that potential arbitrators meeting the necessary qualifications and experience set out in this Schedule 27 are on the list; or
 - (ii) if one Party fails to submit its list of potential arbitrators to the court within five Business Days following a request from the court to submit a list, from the list submitted by the other Party provided that potential arbitrators meeting the necessary qualifications and experience set out in this Schedule 27 are on the list of that other Party; or
 - (iii) if no list is submitted by either Party, or if the list or lists submitted do not include potential arbitrators with the necessary qualifications and experience, the court shall be entitled at its sole discretion to appoint anyone who meets the requirements set out in this Schedule 27 for the qualifications and experience of the arbitrator.

7.4 If the arbitration tribunal is comprised of three arbitrators:

- (a) the arbitrators shall be appointed as follows:
 - (i) each Party shall appoint one arbitrator no later than five Business Days after delivery of the Notice to arbitrate pursuant to Section 6 of this Schedule 27;
 - (ii) if a Party fails to appoint an arbitrator within five Business Days after delivery of the Notice to arbitrate, the other Party is entitled to apply to the Ontario Superior Court of Justice to appoint that arbitrator, in which case the court shall appoint that arbitrator at the earliest opportunity using a comparable process to that described in Section 7.3(b) of this Schedule 27;
 - (iii) the arbitrators appointed in accordance with the foregoing shall, within five Business Days after their appointment, jointly appoint a third arbitrator who shall also act as the chair of the arbitration tribunal and who, in addition to all other required qualifications, shall have experience in arbitration or judicial processes and procedures; and
 - (iv) if the two arbitrators appointed by the Parties fail to appoint a third arbitrator within the required time, either of the other two arbitrators may apply to the Ontario Superior Court of Justice for appointment of the third arbitrator, in which case the court shall appoint the third arbitrator at the earliest opportunity using a comparable process to that described in Section 7.3(b) of this Schedule 27; and
- (b) the arbitrators appointed by the Parties shall at all times be neutral and act impartially and shall not act as advocates for the interests of the Party who appointed them.

- 7.5 All arbitrators must have qualifications and experience relevant to the issues in the Dispute and also have qualifications and experience as arbitrators. Where the issues in Dispute include whether Project Co has or will adversely impact the Contracting Authority Activities, then such qualifications and experience should include relevant experience in the provision of activities similar to the Contracting Authority Activities.
- 7.6 No one shall be nominated or appointed to act as an arbitrator who is or was in any way interested, financially or otherwise, in the conduct of the Works or in the business affairs of Contracting Authority, Project Co, or any consultant, subconsultant or subcontractor of any of them.
- 7.7 The arbitrator(s) shall have the jurisdiction and power to:
- (a) amend or vary any and all rules under the *Arbitration Act, 1991* (Ontario), including rules relating to time limits, either by express agreement of the Parties or, failing such agreement, as the arbitrator(s) consider appropriate and necessary in the circumstances to resolve the Dispute and render an award;
 - (b) require some or all of the evidence to be provided by affidavit;
 - (c) hold a hearing at which evidence and submissions are presented by the Parties;
 - (d) direct either or both Parties to prepare and provide the arbitrator(s) with such documents, test results or other things as the arbitrator(s) may require to assist them in the resolution of the Dispute and rendering of an award;
 - (e) require either Party to supply or prepare for examination by the arbitrator(s) and the other Party, any document or information the arbitrator(s) considers necessary;
 - (f) inspect the Works, giving reasonable Notice to each Party of the time when, and the place where, the arbitrator(s) intend(s) to conduct any inspections;
 - (g) award any remedy or relief that a court or judge of the Ontario Superior Court of Justice could order or grant subject to and in accordance with the Project Agreement, including interim orders, interim and permanent injunctions, and specific performance; and
 - (h) require either or both Parties to take and provide to the arbitrator(s) such measurements, perform such tests, perform such audits, or take any and all such other measures or steps as the arbitrator(s) consider necessary or desirable to aid them in making a fair and reasonable award.
- 7.8 The place of arbitration shall be Toronto, Ontario. The language of the arbitration shall be English.
- 7.9 The costs of an arbitration are in the discretion of the arbitrator(s) who, in addition to any jurisdiction and authority under applicable law to award costs, has the jurisdiction and authority to make an order for costs on such basis as the arbitrator(s) considers appropriate in the circumstances, including to award actual legal fees and disbursements and expert witness fees, and to specify or order any or all of the following:
- (a) the Party entitled to costs;

- (b) the Party who must pay the costs;
 - (c) the amount of the costs or how that amount is to be determined; and
 - (d) how all or part of the costs must be paid.
- 7.10 In exercising discretion to award costs, however, the arbitrator(s) will take into account the desire of the Parties that costs should generally be awarded to each Party in proportion to the relative success that each Party has in the arbitration.
- 7.11 The award of the arbitrator(s) shall be final and binding upon both Parties, and both Parties expressly waive all rights of appeal in connection with the award of the arbitrator(s). Judgment may be entered upon the award in accordance with Applicable Law in any court having jurisdiction.
- 7.12 The Parties agree to and shall co-operate fully with the arbitrator(s) and proceed with the arbitration expeditiously, including in respect of any hearing, in order that an award may be rendered as soon as practicable by the arbitrator(s), given the nature of the Dispute. The arbitrator(s) shall render a decision as soon as possible and, in any event, shall use all reasonable efforts to render a decision no later than 20 Business Days after the date of the hearing, or such longer period of time as agreed to in writing by the Parties. If the arbitration tribunal is comprised of three arbitrators, the decision of a majority of the arbitration tribunal shall be deemed to be the decision of the arbitration tribunal, and where there is no majority decision, the decision of the chair of the arbitration tribunal shall be deemed to be the decision of the arbitration tribunal.
- 7.13 The Project Agreement, including this Schedule 27, constitutes an agreement to arbitrate that shall be specifically enforceable.
- 7.14 Any arbitrator appointed pursuant to this Section 7 of this Schedule 27 shall keep all information about the Dispute confidential and shall not disclose such information to anyone other than the Parties.

8. Litigation

- 8.1 Notwithstanding that a Notice to arbitrate has been delivered pursuant to Section 6.1 of this Schedule 27, following receipt of the Adjudicator's award or determination pursuant to Section 5 of this Schedule 27, or if applicable, a Notice of Dispute has been issued following receipt of a decision of the Independent Certifier if the Dispute is a Dispute in relation to the Independent Certifier's decisions for which Section 4.4 of this Schedule 27 provides that Section 5 of this Schedule 27 shall not apply, if one or more of the following apply then either Party may elect, by written Notice signed by their Party Representative, to require that the Dispute be referred to and resolved solely by litigation in the Ontario Superior Court of Justice, and both Parties agree to attorn to the exclusive jurisdiction of the courts of the Province of Ontario in respect of the Dispute:
- (a) if the actual or potential total value or amount at issue in the Dispute (as determined by adding all claims and counterclaims) is more than \$[REDACTED] (index linked) in the aggregate or \$[REDACTED] (index linked) in any one year; or
 - (b) if the Dispute is considered by Contracting Authority to involve material issues of public health or safety.

Such Notice will not be effective unless it indicates it is a Notice to submit the Dispute to litigation, is signed by the Party Representative and is delivered to the other Party Representative within 15 Business Days after receipt of the Adjudicator's determination, or the Notice of Dispute referred to in Section 6.1(c) of this Schedule 27, as applicable, and provided further that such Notice expressly identifies the specific Dispute and determination of the Adjudicator or Independent Certifier, as applicable, that is to be the subject of the litigation.

- 8.2 If neither Party delivers a Notice of election to resolve a particular Dispute by litigation in the manner and within the time specified in Section 8.1 of this Schedule 27, then provided that one Party has, in the manner and within the time period specified in Section 6.1 of this Schedule 27, given Notice to the other Party of election to resolve that Dispute by arbitration, and subject to a consolidation of proceedings pursuant to Section 9 of this Schedule 27, that Dispute shall be resolved only by arbitration pursuant to Sections 7.2 to 7.14 of this Schedule 27.

9. Consolidation of Project Agreement Adjudication, Arbitration and Litigation

- 9.1 For all Disputes that arise prior to Substantial Completion, unless:

- (a) both Parties otherwise agree;
- (b) the issue in a particular Dispute arises in connection with the Review Procedure;
- (c) the issue in a particular Dispute is such that waiting until after Substantial Completion to resolve that Dispute will cause irreparable harm to one of the Parties;
- (d) the issue in a particular Dispute arises in connection with requirements of achieving or deficiencies in not achieving Substantial Completion; or
- (e) in respect to a particular Dispute, the Dispute is consolidated with any Third Party Arbitration or Third Party Litigation (as hereinafter defined) pursuant to Section 10 of this Schedule 27,

all adjudication, arbitral and litigation proceedings between the Parties prior to Substantial Completion shall be stayed and consolidated into, as applicable, a single adjudication, arbitration and a single litigation proceeding, with the adjudication, arbitration and, if applicable, litigation, proceeding promptly and expeditiously after Substantial Completion.

10. Consolidation with Third Party Disputes

- 10.1 Subject to Section 10.4 of this Schedule 27, if either Party is involved in an arbitration in the Province of Ontario with a third party ("**Third Party Arbitration**"), and if such Third Party Arbitration involves common factual or legal issues (including common issues of damages) which are also the subject of a Dispute between the Parties for which a Notice of Dispute has been given, then any arbitration of the Dispute between the Parties which includes those common factual, legal or damages issues ("**Project Agreement Arbitration**") shall be stayed, consolidated or joined with the Third Party Arbitration(s) but only if Contracting Authority, Project Co and the other Parties all agree or, failing their agreement, if a court in the Province of Ontario on application considers it just and convenient in all the circumstances that the Project Agreement Arbitration should be stayed or consolidated or joined with the Third Party Arbitration.

10.2 Subject to Section 10.4 of this Schedule 27, if either Party is involved in litigation in the Province of Ontario with a third party (“**Third Party Litigation**”) and if:

- (a) such Third Party Litigation involves common factual or legal issues (including common issues of damages) which are the subject of a Project Agreement Arbitration; and
- (b) one of the Parties is brought directly into the Third Party Litigation as a Party to that litigation,

then on the application of either Party to the court in the Province of Ontario having jurisdiction the court may, if it determines that it is just and convenient in all the circumstances, order a stay of either or both the Project Agreement Arbitration proceeding and Third Party Litigation, or order a joinder of the Project Agreement Arbitration and the Third Party Litigation. If such joinder is ordered, the Project Agreement Arbitration and the Third Party Litigation ordered to be joined by the court shall be determined by that court or by another court in Ontario such that the Project Agreement Arbitration and the Third Party Litigation shall be resolved in one forum. For purposes of the foregoing, joinder of the Project Agreement Arbitration and the Third Party Litigation shall be construed to include stays and conditional stays of issues in the Project Agreement Arbitration pending the commencement and completion of third party proceedings by one or both of the Parties in the Third Party Litigation.

10.3 In considering whether to order a stay, consolidation or joinder of a Project Agreement Arbitration with a Third Party Arbitration or Third Party Litigation, the court will be entitled to give substantial weight to the desire by the Parties that all Disputes which are related to Third Party Arbitration or Third Party Litigation be resolved in a single forum to avoid multiplicity of proceedings and the potential for contradictory findings of fact, liability and quantum, and to ensure the arbitrator or court has the advantage of obtaining full evidence and disclosure from the Parties and from the other Parties, as applicable and as required to resolve the Dispute and to make findings of fact, liability and quantum of damages and awards or judgments binding on the Parties based on all available evidence.

10.4 Sections 10.1 and 10.2 of this Schedule 27 only apply:

- (a) if the Dispute between the Parties includes a claim by one Party against the other for contribution or indemnity for that Party’s liability or potential liability to the third party where such liability results or will result from an award in the Third Party Arbitration or a judgment in the Third Party Litigation; and
- (b) to those specific issues that are common issues in the Project Agreement Arbitration, the Third Party Arbitration and the Third Party Litigation, such that all other issues in the Dispute shall continue to be resolved by Project Agreement Arbitration and shall not be consolidated with the Third Party Arbitration or Third Party Litigation.

11. Miscellaneous

11.1 Project Co and Contracting Authority shall diligently carry out their respective obligations under the Project Agreement during the pendency of any Disputes, including adjudication proceedings, arbitration proceedings or litigation proceedings. If during the pendency of any Dispute it is considered necessary by either Party to proceed in respect of the matter that is in Dispute, then

- without prejudice to Project Co's rights in respect of the Dispute (including in respect of Delay Events, Compensation Events and Variations), Project Co shall proceed in accordance with the direction of Contracting Authority, and in the event the matter in dispute is determined in favour of Project Co, then, to the extent that such Dispute affects the New Metrolinx Infrastructure or the New Third Party Infrastructure, proceeding in accordance with Contracting Authority's position: (i) prior to Substantial Completion, shall, subject to and in accordance with Section 32 of the Project Agreement, be treated as a Delay Event; and subject to and in accordance with Section 33 of the Project Agreement, be treated as a Compensation Event; and (ii) following Substantial Completion shall, subject to and in accordance with Schedule 22 – Variation Procedure, result in a Variation. For greater certainty, in respect of any Dispute relating to the Works referred to in Section 4.2 of this Schedule 27, the Independent Certifier shall be the decision maker of first instance and the Parties shall comply with the initial decision of the Independent Certifier unless and until it is overturned in a subsequent arbitration or litigation proceeding.
- 11.2 Nothing contained in this Schedule 27 will prevent the Parties from seeking interim protection from the courts of the Province of Ontario, including seeking an interlocutory injunction, if necessary to prevent irreparable harm to a Party.
- 11.3 The Parties shall indemnify each other in respect of any damages suffered or incurred on amounts agreed to be paid pursuant to resolution of a Dispute by the Party Representatives or by the executives of the Parties pursuant to Sections 2 and 3 of this Schedule 27, and on the amount of any award or judgment as follows:
- (a) for amounts payable by Project Co to Contracting Authority, Project Co shall indemnify Contracting Authority as provided for at Section 46.1(e) of the Project Agreement from and against any damages suffered or incurred resulting from any overpayment to Project Co or, as applicable, any underpayment or non-payment by Project Co from the date of any overpayment to Project Co or, as applicable, from the date on which payment was due under the Project Agreement to Contracting Authority until the date of payment; or
 - (b) for amounts payable by Contracting Authority to Project Co, Contracting Authority shall indemnify Project Co as provided for at Section 46.2(d) of the Project Agreement from and against any damages suffered or incurred resulting from any overpayment to Contracting Authority or, as applicable, any underpayment or non-payment by Contracting Authority from the date of any overpayment to Contracting Authority or, as applicable, from the date on which payment was due under the Project Agreement to Project Co until the date of payment.
- 11.4 Project Co shall ensure that any and all documents and other information in the possession or control of any Project Co Party that are available to Project Co and that may be necessary for the resolution of a Dispute on an informed basis by the Party Representatives or by the executives of the Parties pursuant to Sections 2 and 3 of this Schedule 27, or by an expert, an adjudicator, an arbitrator or a court of competent jurisdiction, are made available in a timely manner to Contracting Authority and the Contracting Authority Representative.
- 11.5 Contracting Authority shall ensure that any and all documents and other information in the possession or control of any Contracting Authority Party that are available to Contracting Authority and that may be necessary for the resolution of a Dispute on an informed basis by the Party Representatives or by the executives of the Parties pursuant to Sections 2 and 3 of this Schedule

27, or by an adjudicator, an arbitrator or court of competent jurisdiction, are made available in a timely manner to Project Co and the Project Co Representative.

11.6 The Parties can, by written agreement, on a Dispute by Dispute basis:

- (a) extend any or all timelines set out in this Schedule 27;
- (b) agree to waive or by-pass any one or more of the Dispute resolution processes in Sections 2, 3, 4 and 5 of this Schedule 27 and, instead, proceed directly to resolution of the Dispute by arbitration or litigation pursuant to Sections 6, 7 and 8 of this Schedule 27; and
- (c) agree to (i) resolve a Dispute by litigation rather than adjudication or arbitration notwithstanding the requirements of Section 5 and Section 7 of this Schedule 27, or (ii) agree to resolve a Dispute by arbitration rather than adjudication or litigation notwithstanding the requirements of Section 5 and Section 8 of this Schedule 27, or (iii) agree to resolve a Dispute by adjudication rather than arbitration or litigation notwithstanding the requirements of Section 7 and Section 8 of this Schedule 27.

11.7 Project Co shall provide Contracting Authority with all reasonable cooperation, access, and assistance for the purposes of considering and resisting any claim made by a third party in connection with the Project, including ensuring that any and all documents and other information in the possession or control of Project Co or any Project Co Party that is available to Project Co or a Project Co Party and that may be necessary for the consideration or resisting of the third party claim on an informed basis by Contracting Authority, are made available in a timely manner to Contracting Authority.

SCHEDULE 28
REFINANCING

1. DEFINITIONS

1.1 In this Schedule 28 – Refinancing, unless the context indicates a contrary intention, terms which are defined in the Project Agreement (and not otherwise defined in this Schedule 28 – Refinancing) shall have meanings given to them in the Project Agreement and the following terms shall have the following meanings:

(a) **“Exempt Refinancing”** means:

- (i) a change in taxation or change in accounting treatment pursuant to a Change in Law or change in Canadian GAAP;
- (ii) the exercise of any right, the grant of any amendment, waiver or consent or any similar action under the Lending Agreements by the Lenders that does not provide for a financial benefit to Project Co under those agreements;
- (iii) any Qualifying Bank Transaction;
- (iv) any Rescue Refinancing;
- (v) any Refinancing that was approved by Contracting Authority prior to the execution of the Project Agreement and occurs during the first six months following the date of the Project Agreement;
- (vi) any amendment, variation or supplement of any agreement approved by Contracting Authority as part of any Variation under the Project Agreement; or
- (vii) any Permitted Borrowing.

(b) **“Qualifying Bank”** means a lending institution that is:

- (i) a bank listed in Schedule I, II or III of the *Bank Act* (Canada); or
- (ii) a bank, life insurance company, pension fund or fund managed by a professional fund manager that controls, either directly or through its affiliates, funds in excess of \$[REDACTED],

provided such institution is not a Restricted Person or a person whose standing or activities compromise (i) Contracting Authority’s reputation or integrity, or (ii) the nature of the public transit system in the Municipality or the Province of Ontario so as to affect public confidence in the public transit system in the Municipality, the Province of Ontario or the Project.

(c) **“Qualifying Bank Transaction”** means:

- (i) the disposition by a Lender of any of its rights or interests in the Lending Agreements to a Qualifying Bank;
 - (ii) the grant by a Lender to a Qualifying Bank of any rights of participation in respect of the Lending Agreements; or
 - (iii) the disposition or grant by a Lender to a Qualifying Bank of any other form of benefit or interest in either the Lending Agreements or the revenues or assets of Project Co, whether by way of security or otherwise.
- (d) **“Qualifying Refinancing”** means any Refinancing that will give rise to a Refinancing Gain that is not an Exempt Refinancing.
- (e) **“Refinancing”** means:
- (i) any amendment, variation, novation, supplement or replacement of any Lending Agreement;
 - (ii) the exercise of any right, or the grant of any waiver or consent, under any Lending Agreement;
 - (iii) the disposition of any rights or interests in, or the creation of any rights of participation in respect of, the Lending Agreements or the creation or granting of any other form of benefit or interest in either the Lending Agreements or the contracts, revenues or assets of Project Co whether by way of security or otherwise; or
 - (iv) any other arrangement put in place by Project Co or another person which has an effect which is similar to any of the foregoing provisions of this definition above or which has the effect of limiting Project Co’s ability to carry out any of the foregoing provisions of this definition.
- (f) **“Refinancing Financial Model”** means a comprehensive and detailed financial model satisfactory to Contracting Authority, acting reasonably, prepared for the purpose of Section 2 of this Schedule 28, which financial model shall be similar in form and content to the Financial Model, suitable for the purposes for which it will be used in this Schedule 28, and shall take into account:
- (i) cash flows for the entire remaining Project Term;
 - (ii) any changes in structure and funding since the date of the Project Agreement;
 - (iii) the performance of the Works to the date of the Refinancing;
 - (iv) macroeconomic assumptions; and
 - (v) all other relevant factors.
- (g) **“Refinancing Gain”** means an amount equal to the greater of zero and $(A - B)$, where:

A = the sum of the Senior Debt Amount and Junior Debt Amount as projected to be outstanding at Substantial Completion immediately prior to the Refinancing (using the Refinancing Financial Model but without taking into account the effect of the Refinancing).

B = the sum of the Senior Debt Amount and Junior Debt Amount as projected to be outstanding at Substantial Completion immediately prior to the Refinancing (using the Refinancing Financial Model and taking into account the effect of the Refinancing).

- (h) “**Rescue Refinancing**” means any Refinancing which takes place due to the failure or prospective failure of Project Co to comply with any material financial obligation under the Lending Agreements, or any of them, which does not increase any liability of Contracting Authority, whether actual or potential.

2. REFINANCING

2.1 Project Co shall not carry out:

- (a) any Qualifying Refinancing unless Project Co has obtained the prior written consent of Contracting Authority, subject to Section 2.2; or
- (b) any Exempt Refinancing or any other Refinancing which does not result in a Refinancing Gain unless Project Co has delivered Notice of such Refinancing to Contracting Authority before five Business Days of such Refinancing, except that such Notice shall not be required for a disposition by a Lender of its rights or participation in the Lending Agreements where such disposition is a trade of bonds issued as provided under a book-based system of a depository and pursuant to a trust indenture that comprises a portion of the Financing.

2.2 Contracting Authority may withhold its consent to any Qualifying Refinancing, in its sole discretion:

- (a) where any person with whom Project Co proposes to carry out a Qualifying Refinancing is a Restricted Person;
- (b) if, at the time the Qualifying Refinancing is contemplated and effected, the Qualifying Refinancing will materially adversely affect the ability of Project Co to perform its obligations under the Project Documents or the Project Agreement; or
- (c) if, at the time the Qualifying Refinancing is contemplated and effected, the Qualifying Refinancing will have the effect of increasing any liability of Contracting Authority, whether actual or contingent, present or future, known or unknown.

2.3 Contracting Authority shall be entitled to receive:

- (a) a **[REDACTED]**% share of any Refinancing Gain arising from a Qualifying Refinancing, in respect of any Refinancing Gain up to (when considered in aggregate with all previous Qualifying Refinancings) a Refinancing Gain of **[\$[REDACTED]]**;

- (b) a [REDACTED]% share of any further Refinancing Gain arising from a Qualifying Refinancing, in respect of any Refinancing Gain in excess of \$[REDACTED] and up to (when considered in aggregate with all previous Qualifying Refinancings) a Refinancing Gain of \$[REDACTED]; and
 - (c) a [REDACTED]% share of any further Refinancing Gain arising from a Qualifying Refinancing.
- 2.4 Project Co shall promptly provide Contracting Authority with full details of any proposed Qualifying Refinancing, including a copy of the proposed Refinancing Financial Model and the basis for the assumptions used in the proposed Refinancing Financial Model. Contracting Authority shall (before, during and at any time after any Refinancing) have unrestricted rights of audit over the Refinancing Financial Model and any documentation (including any aspect of the calculation of the Refinancing Gain) used in connection with such Refinancing (whether or not such Refinancing is determined to be a Qualifying Refinancing). Project Co shall promptly, and, in any event, within five Business Days after receiving a written request from Contracting Authority, provide any information in relation to a proposed Refinancing as Contracting Authority may reasonably require. Project Co shall keep Contracting Authority informed as to any changes to the terms of the Refinancing. Both Contracting Authority and Project Co shall at all times act in good faith with respect to any Refinancing.
- 2.5 Contracting Authority's share of the Refinancing Gain shall be received as a reduction in the amount of the Substantial Completion Payment.
- 2.6 Contracting Authority and Project Co will negotiate in good faith to agree upon the basis and method of calculation of the Refinancing Gain. If the parties fail to agree upon the basis and method of calculation of the Refinancing Gain or the payment of Contracting Authority's share, the Dispute shall be determined in accordance with Schedule 27 - Dispute Resolution Procedure. Both Contracting Authority and Project Co shall work collaboratively to establish the rate setting process required to complete the Refinancing.
- 2.7 The Refinancing Gain shall be calculated after taking into account the reasonable out-of-pocket costs that each Party directly incurs in relation to the Qualifying Refinancing and on the basis that, within 15 Business Days following any Qualifying Refinancing, Project Co will reimburse Contracting Authority for all such reasonable out-of-pocket costs incurred by Contracting Authority.

SCHEDULE 29

FORM OF PERFORMANCE GUARANTEE OF CONSTRUCTION GUARANTOR

THIS GUARANTEE is made as of July 25, 2019

BETWEEN:

ONTARIO INFRASTRUCTURE AND LANDS CORPORATION, a Crown agent, continued under the *Ontario Infrastructure and Lands Corporation Act, 2011*, S.O. 2011

- AND -

METROLINX, a non-share capital corporation continued under the Metrolinx Act, 2006, S.O. 2006, c. 16 and a Crown agency in accordance with the Crown Agency Act, R.S.O. 1990, c. 48

(collectively, “**Contracting Authority**”)

- AND -

[REDACTED]

(“**Construction Guarantor**”)

WHEREAS:

- A. Contracting Authority and GCRS Davenport General Partnership, [REDACTED] (“**Project Co**”) have entered into a project agreement dated as of July 25, 2019 (which agreement, including the schedules thereto, as the same may be amended, modified, restated, supplemented or replaced, from time to time, is hereinafter called the “**Project Agreement**”).
- B. As an inducement to Contracting Authority to enter the Project Agreement with Project Co, Construction Guarantor has agreed to absolutely, unconditionally and irrevocably guarantee to Contracting Authority, as a direct obligation, the full and prompt performance and observance by Project Co of each and every covenant, agreement, undertaking and obligation of Project Co contained in the Project Agreement with respect to the Design and Construction Work (as such term is defined in Section 1.1(c) of this Guarantee), and in furtherance thereof has agreed to enter into this Guarantee.
- C. IO, as Crown agent, and Metrolinx, as Crown agency, intend to enter into this Guarantee in accordance with Applicable Law, and to be liable, on a joint and several basis, for all of the obligations of Contracting Authority pursuant to this Guarantee, save and except as provided for in this Guarantee.

NOW THEREFORE IN CONSIDERATION of the mutual covenants and agreements of the parties hereinafter contained and for other good and valuable consideration, the receipt and sufficiency of which are hereby acknowledged, the parties covenant and agree as follows:

1. DEFINITIONS AND INTERPRETATION

1.1 Definitions

- (a) Unless otherwise defined herein, all capitalized terms will have the meanings ascribed to them in the Project Agreement.
- (b) Unless otherwise expressly provided herein, this Guarantee shall be interpreted in accordance with Schedule 1 – Definitions and Interpretation of the Project Agreement.
- (c) For the purpose of this Guarantee, the term “**Design and Construction Work**” means:
 - (i) subject to Section 1.1(c)(ii) below, all of Project Co’s covenants, obligations and activities with respect to the Works pursuant to the Project Agreement, and including, for certainty:
 - (A) all of Project Co’s covenants, obligations and activities pursuant to Sections 11.15 (Defective Works), 11.16 (Warranty Obligations) and 11.17 (Warranty Work and Prompt Repair of Warranty Work) of the Project Agreement; and
 - (B) Project Co’s representations and warranties contained in Section 6.1 of the Project Agreement, except for:
 - (1) Section 6.1(a)(vii), which for the purposes of this Guarantee shall be amended by replacing “Project Co Event of Default” with “Project Co Construction Event of Default” as such term is defined in Schedule 1 to the Project Agreement, and
 - (2) Section 6.1(a)(xx), which for the purposes of this Guarantee shall be excluded from the definition of “Design and Construction Work” in accordance with Section 1.1(c)(ii)(E) below;
 - (ii) for the purpose of this Section 1.1(c) the term “Design and Construction Work” shall be deemed not to include any of the following covenants, obligations or activities of Project Co under the Project Agreement (including the delivery of any executed originals of the documents referred to below):
 - (A) any covenant, agreement, undertaking or obligation related to the Financing or the Cost of the Financing;
 - (B) the recitals to the Project Agreement;
 - (C) Section 2;
 - (D) Sections 4.2, 4.3, 4.4 and 4.8;
 - (E) Section 6.1(a)(xx);
 - (F) Sections 8.3 and 8.4;

- (G) Section 36.1(a)(iv);
 - (H) Sections 49.3(c) and (d);
 - (I) Section 51;
 - (J) Schedule 2 – Completion Documents;
 - (K) Schedule 4 – Lenders’ Direct Agreement;
 - (L) any of Project Co’s obligations under Schedule 5 – Construction Contractor’s Direct Agreement;
 - (M) Schedule 3 – Subcontractor’s Direct Agreement;
 - (N) Schedule 29 – Form of Performance Guarantee of Construction Guarantor;
 - (O) Schedule 23 – Compensation on Termination;
 - (P) Schedule 32 – Financial Model; or
 - (Q) Schedule 31 – Project Co Information.
- (d) For the purpose of this Guarantee, the term “**DB Guarantee**” means the performance guarantee delivered by [REDACTED] (the “**DB Guarantor**”), acting by its administrator Graham Group Ltd. (the “**Administrator**”) in favour of Project Co and assigned to the Senior Lenders pursuant to the Lending Agreements.
- (e) For the purpose of this Guarantee, the term “**Guaranteed Obligations**” has the meaning given in Section 2.1(a).
- (f) For the purpose of this Guarantee, the term “**Notice**” has the meaning given in Section 4.1.

1.2 Survival

This Guarantee shall survive the termination or other expiry of the Project Agreement.

2. GUARANTEE

2.1 Guarantee

- (a) Construction Guarantor does hereby absolutely, unconditionally and irrevocably guarantee to Contracting Authority, as a direct obligation, the full and prompt performance and observance by Project Co of each and every covenant, agreement, undertaking and obligation of Project Co contained in the Project Agreement with respect to the Design and Construction Work (collectively, the “**Guaranteed Obligations**”), and for greater certainty the Guaranteed Obligations do not include any covenants, agreements, undertakings and obligations of Project Co under the Project Agreement which are not expressly defined in this Section 2.1(a).

- (b) Notwithstanding any other provision of this Guarantee:
- (i) Construction Guarantor's undertakings and obligations are derivative of and not in excess of Project Co's obligations under the Project Agreement and Construction Guarantor retains all rights, claims, defences and limitations of liability possessed by Project Co under the terms of the Project Agreement or arising from the Parties' performance or failure to perform thereunder and shall be entitled to assert any contractual defences that would have been available to Project Co, including, for greater certainty, that the alleged non-performance or non-observance by Project Co of the Guaranteed Obligations arises out of or is a result of a Contracting Authority Event of Default as set out in section 37.1(a) of the Project Agreement; and
 - (ii) in no event shall the aggregate liability of the Construction Guarantor under this Guarantee and the DB Guarantor under the DB Guarantee exceed the maximum liability of the DB Guarantor under the DB Guarantee, but this limit of liability shall not extend to interest and enforcement costs payable under this Guarantee.

2.2 General Provisions Relating to the Guarantee

- (a) Each and every default in performance or observance of any of the Guaranteed Obligations by Project Co shall give rise to a separate claim and cause of action hereunder, and separate claims or suits may be made and brought, as the case may be, hereunder as each such default occurs.
- (b) The Guarantee herein provided for shall be a continuing, absolute and unconditional guarantee of performance and observance of the Guaranteed Obligations and shall remain in full force and effect until each and all of the Guaranteed Obligations shall have been fully and satisfactorily discharged in accordance with the terms and provisions of the Project Agreement and Construction Guarantor shall have fully and satisfactorily discharged all of its obligations under this Guarantee.
- (c) The liability of Construction Guarantor hereunder shall remain in full force and effect irrespective of and shall in no way be affected or impaired by (and no Notice to Construction Guarantor shall be required in respect of):
- (i) any compromise, waiver, renewal, extension, indulgence, amendment, addition, deletion, change in, modification of, or release of any security (including any other guarantee, letter of credit or bond) for or in respect of any of the Guaranteed Obligations;
 - (ii) any amalgamation, merger or consolidation of Project Co or Construction Guarantor or any sale, lease or transfer of any of the assets of Project Co or Construction Guarantor;
 - (iii) any Change in Ownership of Project Co or Construction Guarantor;
 - (iv) the termination or other expiry of the Project Agreement;
 - (v) any Delay Event (it being acknowledged, however, that the performance of the Guaranteed Obligations shall be extended accordingly);
 - (vi) any change in the financial condition of Project Co or Construction Guarantor;

- (vii) any Project Co Event of Default described in Section 36.1(a)(i) of the Project Agreement, or any resulting release, stay or discharge of any Guaranteed Obligation;
 - (viii) any lack or limitation of power, incapacity or disability on the part of Project Co or any other irregularity, defect or informality on the part of Project Co with respect to the Guaranteed Obligations;
 - (ix) any provision of any laws, statutes, rules or regulations of general application in relation to suretyship or any other circumstance that might constitute, under law generally applicable to suretyship, a defence available to, or a discharge of, Construction Guarantor in respect of the Guaranteed Obligations or this Guarantee;
 - (x) the exercise of any rights under the Lending Agreements, including the right of Lenders to cure any Project Co Event of Default by or on behalf of Project Co hereunder and/or to assume the obligations of Project Co and complete the Design and Construction Work in the manner provided in the Project Agreement;
 - (xi) the assignment by Contracting Authority in accordance with the provisions of Section 49.2 of the Project Agreement; or
 - (xii) any other occurrence or circumstance whatsoever, whether similar or dissimilar to the foregoing that, under law generally applicable to suretyship, might otherwise constitute a legal or equitable defence or discharge of the liabilities of a guarantor or surety that might otherwise limit recourse against Construction Guarantor.
- (d) The obligations and liabilities of Construction Guarantor hereunder shall not be impaired, diminished, abated or otherwise affected by the commencement by or against Project Co or Construction Guarantor of any proceedings under any bankruptcy or insolvency law or laws relating to the relief of debtors, readjustment of indebtedness, reorganizations, arrangements, compositions or extension or other similar laws.
- (e) Contracting Authority shall not be bound to exhaust their recourse against Project Co or others or any securities (including the Security described in Schedule 25 – Insurance and Performance Security Requirements of the Project Agreement) or other guarantees it may at any time hold before being entitled to performance of the Guaranteed Obligations by the Construction Guarantor and Construction Guarantor renounces all benefits of discussion and division.
- (f) It is the intent and purpose hereof that Construction Guarantor shall not be entitled to and does hereby waive any and all defences which are, under law generally applicable to suretyship, available to a guarantor, sureties and other secondary parties at law or in equity. Without limiting the generality of the foregoing, Construction Guarantor hereby waives Notice of acceptance of this Guarantee and of the non-performance by Project Co, diligence, presentment, protest, dishonour, demand for performance from Contracting Authority and Notice of non-performance or failure to perform on the part of Project Co and all other Notices whatsoever. The Guarantee hereunder is a guarantee of performance and compliance. In order to hold Construction Guarantor liable hereunder, there shall be no obligation on the part of Contracting Authority at any time to demand or resort for performance to Project Co, its properties or assets or to any security, property or other rights or remedies whatsoever, nor shall there be any requirement that Project Co be joined as a

party to any proceeding for the enforcement of any provision of this Guarantee and Contracting Authority shall have the right to enforce the provisions of this Guarantee irrespective of whether or not legal proceedings or other enforcement efforts against Project Co are pending, seeking resort to or realization upon or from any of the foregoing. Without limiting the foregoing, it is understood that repeated and successive demands may be made and recoveries may be had hereunder as and when from time to time, Project Co shall default under or with respect to any of the Guaranteed Obligations, and that, notwithstanding recovery hereunder for or in respect of any such default, the Guarantee herein shall remain in full force and effect unamended and shall apply to each and every subsequent default.

- (g) Without prejudice to and without releasing, discharging, limiting or otherwise affecting in whole or in part the obligations and liabilities of Construction Guarantor under this Guarantee and without in any way requiring the consent of or giving Notice to Construction Guarantor, Contracting Authority may grant time, renewals, extensions, indulgences, releases and discharges to and accept compositions from or otherwise deal with Project Co and/or Construction Guarantor or others, including any other guarantor, as Contracting Authority may see fit and Contracting Authority may take, abstain from taking or perfecting, vary, exchange, renew, discharge, give up, realize on or otherwise deal with security and guarantees in such manner as Contracting Authority may see fit.
- (h) Neither an action or proceeding brought under this Guarantee regarding the Guaranteed Obligations nor any judgment or recovery in consequence of that action or proceeding operates as a bar or defence action or defence to any further action that may be brought under this Guarantee. Construction Guarantor acknowledges that, if judgment is granted on an action or proceeding commenced under this Guarantee, the obligations of Construction Guarantor to Contracting Authority do not merge with or end Construction Guarantor's obligations hereunder.
- (i) The liability of Construction Guarantor under this Guarantee shall arise forthwith after demand has been made in writing on Construction Guarantor.
- (j) Construction Guarantor agrees to pay to Contracting Authority any and all reasonable and direct out-of-pocket costs and expenses, including reasonable legal fees (on a substantial indemnity basis) incurred by it in connection with enforcing any of its rights hereunder.

3. REPRESENTATIONS AND WARRANTIES

3.1 Construction Guarantor Representations and Warranties

- (a) Construction Guarantor represents and warrants to Contracting Authority that as of the date of this Guarantee:
 - (i) Construction Guarantor is a trust established and validly existing under the laws of the jurisdiction of its organization, is in good standing with the Ministry of Government and Consumer Services of Ontario with respect to the filing of annual returns, and through the Administrator, has all the requisite corporate power and authority to own, lease and operate its properties and assets, to carry on its business as it is currently being conducted, to enter into this Guarantee and the Ancillary Documents to which it is a party and to perform its obligations hereunder and thereunder;

- (ii) Construction Guarantor has the requisite power, authority and capacity to execute and deliver and perform this Guarantee and the Ancillary Documents to which it is a party, and to do all acts and things, and execute, deliver and perform all other agreements, instruments, undertakings and documents as are required by this Guarantee and the Ancillary Documents to which it is a party to be done, executed, delivered or performed;
- (iii) no steps or proceedings have been taken or are pending to supersede, repeal or amend its or the Administrator's constating documents, articles or by-laws or any shareholders agreement or trust indenture in a manner that would materially impair or limit its ability to perform its obligations under this Guarantee or any of the Ancillary Documents to which it is party and such documents and agreements are in full force and effect as of the date hereof;
- (iv) **[REDACTED]**
- (v) the authorization, execution, delivery and performance by Construction Guarantor of this Guarantee and the Ancillary Documents to which it is a party do not violate or conflict with, or constitute a default under:
 - (A) its constating or organizational documents or any unanimous shareholders agreement, trust indenture or similar rights agreement binding on Construction Guarantor;
 - (B) any Applicable Law; or
 - (C) any covenant, contract, instrument, agreement or understanding to which it is a party or by which it or any of its properties or assets is bound or affected;
- (vi) the Construction Guarantor indirectly owns 100% of the shares of GCP Davenport Inc., which owns 50% of the units of Project Co. The remaining 50% of the units of Project Co are owned by Gracorp Davenport Inc., which is not directly or indirectly owned by the Construction Guarantor;
- (vii) there are, to the knowledge of its senior management, no actions, suits, proceedings, or investigations pending or threatened against Construction Guarantor or the Administrator, at law or in equity, before any Governmental Authority or arbitral body (whether or not covered by insurance) that individually or in the aggregate could result in any material adverse effect on the business, properties, or assets, or the condition, financial or otherwise, of Construction Guarantor or the Administrator or in any impairment of its ability to perform its obligations under this Guarantee or any Ancillary Documents to which it is a party, and Construction Guarantor has no knowledge of any violation or default with respect to any order, writ, injunction or decree of any Governmental Authority or arbitral body that would result in any such material adverse effect or impairment; and
- (viii) Construction Guarantor is able to meet its obligations as they generally become due.

4. NOTICES

4.1 Notices to Parties

All notices, requests, demands, instructions, certificates, consents and other communications (each being a “**Notice**”) required or permitted under this Guarantee shall be in writing (whether or not “written notice” or “notice in writing” is specifically required by the applicable provision of this Guarantee) and served by sending the same by registered mail, facsimile or by hand, (in each case, with a copy by electronic transmission) as follows:

If to Contracting Authority:

[REDACTED]

Fax No.: **[REDACTED]**

Attn.: **[REDACTED]**

With a copy to:

[REDACTED]

Fax No.: **[REDACTED]**

Attn.: **[REDACTED]**

If to Construction Guarantor:

[REDACTED]

Fax No.: **[REDACTED]**

Attn: **[REDACTED]**

Email: **[REDACTED]**

With a copy to:

Attn: **[REDACTED]**

Email: **[REDACTED]**

4.2 Facsimile

Where any Notice is provided or submitted to a party via facsimile, an original of the Notice sent via facsimile shall promptly be sent by regular mail or registered mail. For greater certainty, a Notice given via facsimile shall not be invalid by reason only of a party’s failure to comply with this Section 4.2.

4.3 Change of Address

Either party to this Guarantee may, from time to time, change any of its contact information set forth in Section 4.1 by prior Notice to the other party, and such, change shall be effective on the

Business Day that next follows the recipient party's receipt of such Notice unless a later effective date is given in such Notice.

4.4 Deemed Receipt of Notices

- (a) Subject to Sections 4.4(b), (c) and (d):
- (i) a Notice given by registered mail shall be deemed to have been received on the third Business Day after mailing;
 - (ii) a Notice given by hand delivery shall be deemed to have been received on the day it is delivered; and
 - (iii) a Notice given by facsimile shall be deemed to have been received on the day it is transmitted by facsimile.
- (b) If the party giving the Notice knows or ought reasonably to know of difficulties with the postal system which might affect negatively the delivery of mail, any such Notice shall not be mailed but shall be made or given by personal delivery or by facsimile transmission in accordance with this Article 4.
- (c) If any Notice delivered by hand or transmitted by facsimile is so delivered or transmitted, as the case may be, either on a day that is not a Business Day or on a Business Day after 4:00 p.m. (recipient's local time), then such Notice shall be deemed to have been received by such recipient on the next Business Day.
- (d) A Notice given by facsimile shall be deemed to have been received by the recipient on the day it is transmitted only if a facsimile transmission report (maintained by the sender) indicates that the transmission of such Notice was successful.

4.5 Service on Contracting Authority

Where any Notice is required to be served on Contracting Authority, the obligation to serve such Notice shall be fulfilled by serving it on Contracting Authority in accordance with the provisions of this Article 4.

5. GENERAL

5.1 Amendments

This Guarantee may not be varied, amended or supplemented except by an agreement in writing signed by duly authorized representatives of the parties and stating on its face that it is intended to be an amendment, restatement or other modification, as the case may be, to this Guarantee.

5.2 Waiver

- (a) No waiver made or given by a party under or in connection with this Guarantee shall be binding or effective unless the waiver is in writing, signed by an authorized representative of the party giving

such waiver, and delivered by such party to the other party. No waiver made with respect to any right, power or remedy in one instance will be deemed to be a waiver with respect to any other instance involving the exercise of such right, power, or remedy or with respect to any other right, power, or remedy.

- (b) Failure by either party to exercise any of its rights, powers or remedies hereunder or its delay to do so shall not constitute a waiver of those rights, powers or remedies. The single or partial exercise of a right, power or remedy shall not prevent its subsequent exercise or the exercise of any other right, power or remedy.

5.3 Entire Agreement

Except where provided otherwise in this Guarantee, this Guarantee, together with the Project Agreement and the Ancillary Documents, constitute the entire agreement between the parties in connection with its subject matter and supersedes all prior representations, communications, negotiations and understandings, whether oral, written, express or implied, concerning the subject matter of this Guarantee, including the Request for Proposals.

5.4 Severability

Each provision of this Guarantee shall be valid and enforceable to the fullest extent permitted by law. If any provision of this Guarantee is declared invalid, unenforceable or illegal by the courts of a competent jurisdiction, such provision may be severed and such invalidity, unenforceability or illegality shall not prejudice or affect the validity, enforceability and legality of the remaining provisions of this Guarantee. If any such provision of this Guarantee is invalid, unenforceable or illegal, the parties shall, acting in good faith, promptly negotiate new provisions to eliminate such invalidity, unenforceability or illegality and to restore this Guarantee as near as possible to its original intent and effect.

5.5 Enurement

This Guarantee shall enure to the benefit of, and be binding on, Contracting Authority and Construction Guarantor and their respective permitted successors and assigns. This Guarantee may not be assigned by the Construction Guarantor.

5.6 Governing Law and Jurisdiction

- (a) This Guarantee shall be governed by and construed in accordance with the laws of Ontario and the laws of Canada applicable therein and shall be treated in all respects as an Ontario contract, without regard to conflict of laws principles.
- (b) Both parties hereby irrevocably attorn to the exclusive jurisdiction of the courts of the Province of Ontario and all courts competent to hear appeals therefrom.
- (c) Nothing in this Guarantee affects the rights, protections and immunities of the Crown under the *Proceedings Against the Crown Act* (Ontario).

5.7 Contracting Authority Designate

- (a) At any time and from time to time, the Crown may designate any ministry, branch, agency, division, department or office of the Government of Ontario to carry out administrative responsibility for the rights and obligations of Contracting Authority under this Guarantee and the Construction Guarantor may deal exclusively with the designated person in respect of all such matters and is entitled to rely on the actions, directions, requests, Notices, consents, approvals, waivers, comments relating to the review of documentation and other administrative matters and decisions determined by such designated person from time to time, until the Crown has notified the Construction Guarantor in writing that such designated person is no longer the person designated by the Crown hereunder and such Notice shall have effect on the later of the date of delivery of such Notice and the date specified in the written Notice. The Crown shall advise the Construction Guarantor in writing of any designation hereunder. The rights and obligations of the parties to this Guarantee shall be in no way affected by reason of any such designation. The Construction Guarantor acknowledges the right of the Crown to delegate administrative responsibilities hereunder as set forth in this Section 5.7.

5.8 Cumulative Remedies

Except as otherwise set forth in this Guarantee, the rights, powers and remedies of each party set forth in this Guarantee are cumulative and are in addition to and without prejudice to any other right, power or remedy that may be available to such party under this Guarantee or the Project Agreement or Ancillary Documents.

5.9 Further Assurance

Each party shall do all reasonable things, from time to time, and execute all reasonable further documents necessary to give full effect to this Guarantee.

5.10 Costs

Each party shall be responsible for paying its own costs and expenses incurred in connection with the negotiation, preparation and execution and delivery of this Guarantee.

5.11 Language of Agreement

- (a) Each of the parties acknowledges having requested and being satisfied that this Guarantee and related documents be drawn in English. Chacune des parties reconnaît avoir demandé que ce document et ses annexes soient rédigés en anglais et s'en déclare satisfaite.
- (b) For greater certainty, all correspondence, Notices, drawings, test reports, certificates, specifications, information, operating and maintenance instructions, name plates, identification labels, instructions and notices to the public and staff and all other written, printed or electronically readable matter required in accordance with, or for purposes envisaged by, this Guarantee shall be in English.

5.12 Proof of Authority

Contracting Authority and Construction Guarantor each reserve the right to require any person executing this Guarantee on behalf of the other party to provide proof, in a form acceptable to Contracting Authority or Construction Guarantor, as applicable, that they have the requisite authority to execute this Guarantee on behalf of and to bind Contracting Authority or Construction Guarantor, as applicable.

5.13 Counterparts

This Guarantee may be executed in one or more counterparts. Any single counterpart or a set of counterparts executed, in either case, by all the parties shall constitute a full, original and binding agreement for all purposes. Counterparts may be executed either in original or faxed form provided that any party providing its signature in faxed form shall promptly forward to the other party an original signed copy of this Guarantee which was so faxed.

5.14 Joint and Several

- (a) If Construction Guarantor is comprised of more than one person, then each such person shall be jointly and severally liable for the obligations and liabilities of Construction Guarantor hereunder.
- (b) IO, as Crown agent, and Metrolinx, as Crown agency, shall be liable, on a joint and several basis, for all of the obligations of Contracting Authority under this Performance Guarantee of Construction Guarantor and for each covenant of the other under this Performance Guarantee of Construction Guarantor.

5.15 Copyright Notice

The parties acknowledge that the Queen's Printer for Ontario is the exclusive owner of the copyright in the Project Agreement.

[SIGNATURE PAGES IMMEDIATELY FOLLOW]

IN WITNESS WHEREOF the Parties have executed this Guarantee as of the date first above written.

**ONTARIO INFRASTRUCTURE AND LANDS
CORPORATION**, a Crown agent, continued under the
Ontario Infrastructure and Lands Corporation Act, 2011

Per: _____

Name: **[REDACTED]**

Title: **[REDACTED]**

I have authority to bind the corporation

METROLINX

Per: _____
Name: **[REDACTED]**
Title: **[REDACTED]**

Per: _____
Name: **[REDACTED]**
Title: **[REDACTED]**

I/We have authority to bind the corporation

[REDACTED]

Per: _____
Name: **[REDACTED]**
Title: **[REDACTED]**

Per: _____
Name: **[REDACTED]**
Title: **[REDACTED]**

I/We have authority to bind the corporation

**SCHEDULE 30
INSURANCE TRUST AGREEMENT**

THIS AGREEMENT is made as of July 25, 2019

AMONG:

ONTARIO INFRASTRUCTURE AND LANDS CORPORATION, a Crown agent, continued under the *Ontario Infrastructure and Lands Corporation Act, 2011*, S.O. 2011

AND:

METROLINX, a non-share capital corporation continued under the Metrolinx Act, 2006, S.O. 2006, c. 16 and a Crown agency in accordance with the Crown Agency Act, R.S.O. 1990, c. 48

(collectively, “**Contracting Authority**”)

AND:

[REDACTED], acting as agent for and on behalf of the Lenders

(the “**Lenders’ Agent**”)

AND:

GCRS DAVENPORT GENERAL PARTNERSHIP, [REDACTED]

(“**Project Co**”)

AND:

[REDACTED]

(the “**Account Trustee**”)

WHEREAS:

- A. Contracting Authority and Project Co have entered into the Project Agreement.
- B. Contracting Authority, the Lenders’ Agent and Project Co have entered into the Lenders’ Direct Agreement.
- C. Contracting Authority, the Lenders’ Agent and Project Co have agreed that all amounts from time to time contained in the Insurance Trust Account are to be held in trust by the Account Trustee in accordance with the terms of this Insurance Trust Agreement, and that no releases, distributions or transfers of any funds from the Insurance Trust Account shall be made other than in accordance with the terms of this Insurance Trust Agreement.

- D. IO, as Crown agent, and Metrolinx, as Crown agency, intend to enter into this Insurance Trust Agreement in accordance with Applicable Law, and to be liable, on a joint and several basis, for all of the obligations of Contracting Authority pursuant to this Insurance Trust Agreement, save and except as provided for in this Insurance Trust Agreement.

NOW THEREFORE in consideration of the mutual covenants and agreements of the Parties hereinafter contained and for other good and valuable consideration, the receipt and sufficiency of which are hereby acknowledged, the Parties covenant and agree as follows:

1. DEFINITIONS

In this Insurance Trust Agreement, unless the context otherwise requires:

- (a) **“Account Trustee”** has the meaning given in the introductory paragraph of this Insurance Trust Agreement.
- (b) **“Appointed Representative”** has the meaning given in the Lenders’ Direct Agreement.
- (c) **“Bank”** means [REDACTED].
- (d) **“Bonds”** means a performance bond issued by [REDACTED], in favour of Project Co, in the form attached to the Project Agreement as Appendix B to Schedule 25 – Insurance and Performance Security Requirements and a labour and material payment bond issued by [REDACTED] in favour of Project Co, in the form attached to the Project Agreement as Appendix C to Schedule 25 – Insurance and Performance Security Requirements.
- (e) **“Business Day”** has the meaning given in the Project Agreement.
- (f) **“Change of Authorization Event”** has the meaning given in Section 9(a) of this Insurance Trust Agreement.
- (g) **“Change of Authorization Notice”** has the meaning given in Section 9(b)(ii) of this Insurance Trust Agreement.
- (h) **“Contracting Authority”** has the meaning given in the introductory paragraph of this Insurance Trust Agreement.
- (i) **“Default Notice”** means a written notice given by the Lenders’ Agent to the Account Trustee and Contracting Authority that an event of default under the Lending Agreements has occurred and is continuing.
- (j) **“Default Period”** means the period commencing on the date upon which the Account Trustee and Contracting Authority receives a Default Notice and ending on the date upon which the Account Trustee and Contracting Authority receives written notice from the Lenders’ Agent that the event of default which was the subject matter of the applicable Default Notice has been cured.
- (k) **“Governmental Authority”** has the meaning given in the Project Agreement.

- (l) **“Insurance Policies”** has the meaning given in Section 4 of this Insurance Trust Agreement.
- (m) **“Insurance Proceeds”** has the meaning given in Section 6(a) of this Insurance Trust Agreement.
- (n) **“Insurance Trust Account”** means the account bearing Account No. [REDACTED] at [REDACTED], in the name of the Account Trustee. The following information is to be used to make a wire transfer payment into the insurance trust account:

RE: Insurance Trustee for GCRS Davenport General Partnership, Metrolinx and Ontario Infrastructure and Lands Corporation (INSURANCE TRUST ACCOUNT)

Canadian Routing Code: N/A
SWIFT: ATBRCA6EXXX
Bank Number: 219
Transit Number: 07609
Beneficiary Name: Computershare Trust Company of Canada
Beneficiary Address: 100 University Avenue 11th Floor
Toronto, ON M5J 2Y1
Beneficiary Account No.: 00502122779

- (o) **“Insurance Trust Agreement”** means this Insurance Trust Agreement.
- (p) **“Lenders”** has the meaning given in the Project Agreement.
- (q) **“Lenders’ Agent”** has the meaning given in the introductory paragraph of this Insurance Trust Agreement.
- (r) **“Lenders’ Direct Agreement”** means the Lenders’ Direct Agreement made on or about the date hereof between Contracting Authority, Project Co and the Lenders’ Agent.
- (s) **“Lending Agreements”** has the meaning given in the Project Agreement.
- (t) **“Multiple Obligee”** means a multiple obligee under the applicable Bond.
- (u) **“Multiple Obligee Rider(s)”** means the multiple obligee rider(s) applicable to the Bonds pursuant to which Project Co, Contracting Authority and the Lenders’ Agent are multiple obligees under the Bonds.
- (v) **“Notice Period”** has the meaning given in the Lenders’ Direct Agreement.
- (w) **“Order”** has the meaning given in Section 8(k) of this Insurance Trust Agreement.
- (x) **“Party”** means any of Contracting Authority, Project Co, the Lenders’ Agent or the Account Trustee, and **“Parties”** means all of Contracting Authority, Project Co, the Lenders’ Agent and the Account Trustee.

- (y) “**Project**” has the meaning given in the Project Agreement.
- (z) “**Project Agreement**” means the project agreement made on or about July 25, 2019 between Contracting Authority and Project Co.
- (aa) “**Project Co**” has the meaning given in the introductory paragraph of this Insurance Trust Agreement.
- (bb) “**Project Co Event of Default**” has the meaning given in the Project Agreement.
- (cc) “**Replacement Project Agreement**” has the meaning given in the Lenders’ Direct Agreement.
- (dd) “**Replacement Project Co**” has the meaning given in the Lenders’ Direct Agreement.
- (ee) “**Step-In Notice**” has the meaning given in the Lenders’ Direct Agreement.
- (ff) “**Step-In Period**” has the meaning given in the Lenders’ Direct Agreement.
- (gg) “**Surety**” has the meaning given in the Project Agreement.
- (hh) “**Trust Property**” means all of the property held in trust by the Account Trustee pursuant to this Insurance Trust Agreement, including the original copy of the Bonds, the Insurance Trust Account, and all amounts from time to time contained therein, the Insurance Policies and the Insurance Proceeds.

2. INTERPRETATION

This Insurance Trust Agreement shall be interpreted according to the following provisions, unless the context requires a different meaning:

- (a) The headings in this Insurance Trust Agreement are for convenience of reference only and shall not constitute a part of this Insurance Trust Agreement, and shall not be taken into consideration in the interpretation of, or affect the meaning of, this Insurance Trust Agreement.
- (b) Unless the context otherwise requires, references to specific Sections, Clauses, Paragraphs, Subparagraphs, and other divisions are references to such Sections, Clauses, Paragraphs, Subparagraphs, or divisions of this Insurance Trust Agreement and the terms “Section” and “Clause” are used interchangeably and are synonymous.
- (c) Words importing persons or parties are to be broadly interpreted and include an individual, corporation, limited liability company, joint stock company, firm, partnership, joint venture, trust, unincorporated organization, Governmental Authority, unincorporated body of persons or association and any other entity having legal capacity, and the heirs, beneficiaries, executors, administrators or other legal representatives of a person in such capacity.

- (d) Unless the context otherwise requires, wherever used herein the plural includes the singular, the singular includes the plural, and each of the masculine, feminine and neuter genders include all other genders.
- (e) References to any standard, principle, agreement or document include (subject to all relevant approvals and any other provisions of this Insurance Trust Agreement concerning amendments) a reference to that standard, principle, agreement or document as amended, supplemented, restated, substituted, replaced, novated or assigned.
- (f) The words in this Insurance Trust Agreement shall bear their natural meaning.
- (g) References containing terms such as:
 - (i) “hereof”, “herein”, “hereto”, “hereinafter”, and other terms of like import are not limited in applicability to the specific provision within which such references are set forth but instead refer to this Insurance Trust Agreement taken as a whole; and
 - (ii) “includes” and “including”, whether or not used with the words “without limitation” or “but not limited to”, shall not be deemed limited by the specific enumeration of items but shall, in all cases, be deemed to be without limitation and construed and interpreted to mean “includes without limitation” and “including without limitation”.
- (h) In construing this Insurance Trust Agreement, the rule known as the ejusdem generis rule shall not apply nor shall any similar rule or approach to the construction of this Insurance Trust Agreement and, accordingly, general words introduced or followed by the word “other” or “including” or “in particular” shall not be given a restrictive meaning because they are followed or preceded (as the case may be) by particular examples intended to fall within the meaning of the general words.
- (i) Where this Insurance Trust Agreement states that an obligation shall be performed “no later than” or “within” or “by” a stipulated date or event which is a prescribed number of days after a stipulated date or event, the latest time for performance shall be 5:00 p.m. on the last day for performance of the obligation concerned, or, if that day is not a Business Day, 5:00 p.m. on the next Business Day.
- (j) Where this Insurance Trust Agreement states that an obligation shall be performed “on” a stipulated date, the latest time for performance shall be 5:00 p.m. on that day, or, if that day is not a Business Day, 5:00 p.m. on the next Business Day.
- (k) Any reference to time of day or date means the local time or date in Toronto, Ontario.
- (l) Unless otherwise indicated, time periods will be strictly construed and time shall be of the essence hereof.
- (m) Whenever the terms “will” or “shall” are used in this Insurance Trust Agreement they shall be construed and interpreted as synonymous and to read “shall”.

3. BONDS AND INSURANCE TRUST ACCOUNT

- (a) Prior to the commencement of a Default Period, the original copy of the Bonds the Insurance Trust Account and all amounts from time to time contained therein, including interest thereon, shall be held in trust by the Account Trustee for the benefit of Project Co. During a Default Period, the original copy of the Bonds and Insurance Trust Account, and all amounts from time to time contained therein, shall be held in trust by the Account Trustee for the benefit of the Lenders' Agent and the Lenders, provided that, upon receipt by the Account Trustee of a Change of Authorization Notice, the original copy of the Bonds, the Insurance Trust Account, and all amounts from time to time contained therein, shall be held in trust by the Account Trustee for the benefit of Contracting Authority.
- (b) The Account Trustee shall not release the original copy of the Bonds or release, distribute or transfer any funds from the Insurance Trust Account other than in accordance with the terms of this Insurance Trust Agreement.
- (c) Notwithstanding any other provision of this Insurance Trust Agreement and subject to Section 3(d), the Lenders' Agent, Contracting Authority, and Project Co agree that (x) if Project Co or the Lenders' Agent receives the original copy of the Bonds, the Bonds will be enforced for the purpose of completion of the Project, and (y) if any of them either receives any Insurance Proceeds from the Insurance Trust Account or has the right to direct the Account Trustee to advance funds in respect of any Insurance Proceeds from the Insurance Trust Account to third parties, such funds shall be directed, used or advanced only for one of the following purposes:
 - (i) the repair, reinstatement, restoration or replacement of the New Metrolinx Infrastructure or New Third Party Infrastructure or any other assets, materials or goods necessary or desirable for the carrying out of the Works in respect of which such Insurance Proceeds have been paid;
 - (ii) the completion of the Project; or
 - (iii) indemnification for any Contracting Authority loss for which the subject Insurance Proceeds were paid under the Insurance Policies (as defined below).

For greater certainty, use of any Insurance Proceeds received in respect of a claim by Project Co for delay in start-up, soft costs or business interruption may be applied in accordance with the terms of the Lending Agreements so as to enable Project Co to carry out the Works.

- (d) Notwithstanding anything in this Insurance Trust Agreement, if Contracting Authority is entitled to indemnification under the Insurance Policies in respect of any loss incurred by Contracting Authority, such related insurance proceeds are to be paid directly to Contracting Authority by the insurer or the Account Trustee and shall not be Insurance Proceeds subject to Section 3(c)(i) or (ii) of this Insurance Trust Agreement. For greater certainty it is understood and agreed that Contracting Authority shall be required to use such proceeds for carrying out the purposes referred to in Sections 3(c)(i) and (ii) in respect of which such proceeds have been paid.

4. DELIVERY OF ORIGINAL BONDS AND INSURANCE POLICIES

Project Co shall deliver, or cause to be delivered, to the Account Trustee an original copy of all Bonds Project Co is required to obtain under the Project Agreement and certified copies or originals of all insurance policies that Project Co is required to maintain under the Project Agreement (collectively, the “**Insurance Policies**”), and the Account Trustee shall hold the original copy of the Bonds and Insurance Policies in trust for the benefit of each of the beneficiaries and loss payees, as the case may be, thereunder.

5. BONDS

- (a) If the Account Trustee and Contracting Authority have received a Default Notice, and if Lenders’ Agent presents to the Account Trustee (and the other parties to this Insurance Trust Agreement) a declaration that it or any person Lenders’ Agent designates requires possession of the original copy of the Bonds for the purpose of establishing and/or enforcing the rights of any Multiple Obligee thereunder, and the Account Trustee has received written authorization from Contracting Authority confirming Lenders’ Agent’s right to receive the original copy of the Bonds, the Account Trustee shall provide the original copy of the Bonds to Lenders’ Agent or such designated party, without the need for further investigation or inquiry by the Account Trustee, provided that, if at any time prior to the release of the original copy of the Bonds to Lenders’ Agent or a person designated by it, pursuant to the foregoing, the Account Trustee receives a Change of Authorization Notice and Contracting Authority presents to the Account Trustee a declaration that it or any person designated by it requires possession of the original copy of the Bonds for the purpose of establishing and/or enforcing the rights of any Multiple Obligee thereunder, the Account Trustee shall provide the same to Contracting Authority or such designated party, without the need for further investigation or inquiry by the Account Trustee that Contracting Authority or the designated party presenting the declaration is entitled to receive the original copy of the Bonds. Contracting Authority shall provide, no later than five Business Days following receipt by Contracting Authority of a request by the Lenders’ Agent, either: (i) the written authorization referred to in this Section 5(a); or (ii) written justification detailing Contracting Authority’s rationale for refusing to provide such authorization.
- (b) Project Co agrees to obtain or cause to be obtained from the Surety any required amendment to the Bonds to provide for the foregoing provisions by way of amendment or replacement of the Multiple Obligee Rider now attached to and forming part of the Bonds.
- (c) Contracting Authority, Lenders’ Agent and Project Co covenant and agree to observe and perform their respective covenants, agreements and obligations under the provisions of the Lender’s Direct Agreement and further covenant and agree as between them, that if there is any conflict or inconsistency between the provisions of Lender’s Direct Agreement and this Insurance Trust Agreement, the provisions of the Lender’s Direct Agreement shall govern and prevail to the extent of such conflict or inconsistency.

6. INSURANCE PROCEEDS

- (a) Subject to Section 3(d), the Account Trustee shall distribute any proceeds of any Insurance Policy that are paid over to it by any insurer, Project Co, the Lenders' Agent or Contracting Authority (the "**Insurance Proceeds**") as follows:
- (i) in the case of third party legal liability or employer's liability insurance, to the relevant claimant in satisfaction of the claim, demand, proceeding or liability in respect of which such Insurance Proceeds are payable;
 - (ii) in the case of any property builders' risk "All Risk" insurance, boiler and machinery insurance or property insurance policies that Project Co is required to maintain under the Project Agreement:
 - (A) if the Account Trustee has not received a Default Notice and:
 - (1) if the amount of such Insurance Proceeds, together with the aggregate of all Insurance Proceeds in respect of the assets in respect of which such Insurance Proceeds have been paid in the same calendar month, is less than \$[REDACTED], to Project Co to repair, restore or replace the assets in respect of which such Insurance Proceeds have been paid; or
 - (2) if the amount of such Insurance Proceeds, together with the aggregate of all Insurance Proceeds in respect of the assets in respect of which such Insurance Proceeds have been paid in the same calendar month, is equal to or greater than \$[REDACTED], to the Lenders' Agent to reimburse Project Co for the costs of repairing, restoring or replacing the assets in respect of which such Insurance Proceeds have been paid; or
 - (B) if the Account Trustee has received a Default Notice, to the Insurance Trust Account to be distributed by the Account Trustee in such amounts and to such persons as the Lenders' Agent may at any time or from time to time direct in writing, provided that, if the Account Trustee has received a Change of Authorization Notice, the Account Trustee shall release such Insurance Proceeds from the Insurance Trust Account in such amounts and to such parties as Contracting Authority may at any time or from time to time direct in writing, in each case, to repair, restore or replace the assets in respect of which such Insurance Proceeds have been paid; and
 - (iii) in the case of any other Insurance Policies, to the Lenders' Agent, or, following receipt by the Account Trustee of a Change of Authorization Notice, to Contracting Authority, to be distributed to the parties entitled thereto.
- (b) The Account Trustee shall distribute any excess Insurance Proceeds remaining after the distributions contemplated in Section 6(a) have been made, including any Insurance Proceeds held in the Insurance Trust Account:

- (i) if the Account Trustee has not received a Default Notice, to Project Co; and
 - (ii) if the Account Trustee has received a Default Notice, to such persons as the Lenders' Agent, or, following receipt by the Account Trustee of a Change of Authorization Notice, Contracting Authority, may at any time or from time to time direct in writing.
- (c) Each of Project Co, the Lenders' Agent and Contracting Authority shall forthwith deliver, or cause to be delivered, to the Account Trustee, any and all Insurance Proceeds it received from time to time and is not otherwise entitled to in accordance with the terms of this Insurance Trust Agreement.
- (d) The Account Trustee shall deposit to the Insurance Trust Account all amounts that are paid over to it pursuant to the Insurance Policies or otherwise by Project Co, Contracting Authority or the Lenders' Agent and shall not transfer, release or distribute any such proceeds other than in accordance with this Insurance Trust Agreement.

7. ACCOUNT AGREEMENT

- (a) The Account Trustee hereby agrees to promptly provide to the Lenders' Agent all monthly statements and other information with respect to the Insurance Trust Account provided to the Account Trustee by the Bank pursuant to the relevant account agreement. The Account Trustee further agrees that it shall make such requests to the Bank for additional information with respect to the Insurance Trust Account as the Lenders' Agent may from time to time request in writing.
- (b) The Account Trustee hereby agrees to promptly provide to Contracting Authority all monthly statements and other information with respect to the Insurance Trust Account provided to the Account Trustee by the Bank pursuant to the relevant account agreement. The Account Trustee further agrees that it shall make such requests to the Bank for additional information with respect to the Insurance Trust Account as Contracting Authority may from time to time request in writing.

8. THE ACCOUNT TRUSTEE

- (a) The Account Trustee shall not have any duty or obligation to manage, control, use, make any payment in respect of, register, record, insure, inspect, sell, dispose of or otherwise deal with any part of the Trust Property except as expressly provided by the terms of this Insurance Trust Agreement. The Account Trustee shall carry out all written directions given by the Lenders' Agent, Contracting Authority or Project Co, as applicable, in accordance with this Insurance Trust Agreement and shall not be required to exercise any discretion in exercising any of its duties under this Insurance Trust Agreement in pursuance of such written directions. The Account Trustee shall not be bound to do or take any act, action or proceeding by virtue of the powers conferred on it hereby unless and until it shall have been required to do so under the terms hereof and has received instruction, advice or direction from the Lenders' Agent, Contracting Authority or Project Co, as applicable, as to the action to be taken (except with respect to actions specifically set out herein to be performed by the Account Trustee).

- (b) The Account Trustee will exercise its powers and carry out its obligations hereunder as account trustee honestly, in good faith and in the best interests of the beneficiaries hereunder and in connection therewith will exercise that degree of care, diligence, and skill that a reasonably prudent professional trustee would exercise in comparable circumstances. Unless otherwise required by law, the Account Trustee will not be required to give bond surety or security in any jurisdiction for the performance of any duties or obligations hereunder. No provision of this Insurance Trust Agreement shall be construed to relieve the Account Trustee from liability for its own dishonesty, fraud, negligence (including negligence in the handling of funds), willful misconduct, bad faith or reckless disregard of any duty hereunder.
- (c) The Account Trustee will not be subject to any liability whatsoever, in tort, contract or otherwise in connection with the Trust Property or the carrying out of its duties under this Insurance Trust Agreement to the Lenders' Agent, the Lenders, Contracting Authority, Project Co or any other person for any action taken or permitted by it to be taken, or for its failure to take any action, or for not performing any act or fulfilling any duty, obligation or responsibility hereunder by reason of any occurrence beyond the control of the Account Trustee (including, but not limited to, any act or provision of any present or future law or of any Governmental Authority, any act of God or war, or the unavailability of any wire or communication facility), provided that the foregoing limitation will not apply in respect of any action or failure to act arising from or in connection with wilful misconduct, negligence or reckless disregard of duty by the Account Trustee. The Account Trustee in doing anything or permitting anything to be done in respect of the Trust Property or the carrying out of its duties under this Insurance Trust Agreement is, and will be conclusively deemed to be, acting as trustee for the beneficiaries hereunder and not in any other capacity. Except to the extent provided in this Section 8(c), the Account Trustee will not be subject to any liability for debts, liabilities, obligations, claims, demands, judgments, costs, charges or expenses against or with respect to the Trust Property, arising out of anything done or permitted by it to be done or its failure to take any action in respect of the execution of its duties hereunder and resort will be had solely to the Trust Property for the payment or performance thereof, and no other property or assets of the Account Trustee, whether owned in its personal capacity or otherwise, will be subject to levy, execution or other enforcement procedure with regard to any obligation under this Insurance Trust Agreement.
- (d) The Account Trustee shall not be required to expend or risk its own funds or otherwise incur financial liability in the performance of any of its duties hereunder, or in the exercise of any of its rights or powers hereunder, or in acting at the request or direction of the Lenders' Agent on behalf of the Lenders or of Contracting Authority or of Project Co, unless it shall have received adequate indemnity or security against such risk or liability satisfactory to it.
- (e) Notwithstanding the foregoing, the Account Trustee shall be liable for any action or failure to act arising from or in connection with the dishonesty, fraud, negligence (including negligence in the handling of funds), wilful misconduct, bad faith or reckless disregard of any duty hereunder by the Account Trustee or any of its directors, officers or employees, or the failure to comply with the standard of care referred to in Section 8(b).

- (f) Except as otherwise provided in Sections 8(c), 8(d) and 8(e):
- (i) the Account Trustee may rely and shall be protected in acting or refraining from acting upon any signature, resolution, certificate, statement, instrument, opinion, report, notice, request, direction, consent, order or other paper or document reasonably believed by it in good faith to be genuine and to have been signed or presented by the proper party or parties; and
 - (ii) the Account Trustee may exercise its powers and perform its duties by or through such attorneys, representatives, agents and employees as it shall appoint; and may consult with counsel, accountants and other skilled persons selected and employed or retained by it, and the Account Trustee shall not be liable for anything done, suffered or omitted in good faith by it in accordance with the written advice of such counsel, accountants or other skilled persons (provided that such advice pertains to such matters as the Account Trustee may reasonably presume to be within the scope of such person's area of competency) and not contrary to any express provision in this Insurance Trust Agreement.
- (g) Project Co hereby agrees to pay, indemnify and hold harmless the Account Trustee from and against any and all loss, liability, cost, claim and expense incurred by the Account Trustee with respect to the performance of this Insurance Trust Agreement by the Account Trustee or any of the Account Trustee's directors, officers or employees, unless arising from its or their own dishonesty, fraud, negligence (including negligence in the handling of funds), wilful misconduct, bad faith or reckless disregard of any duty hereunder.
- (h) Subject to the terms and conditions set forth in the Account Trustee fee letter, the Account Trustee shall receive from the Trust Property reasonable compensation for its services hereunder and shall be reimbursed by Project Co for its reasonable fees and expenses (including the disbursements and reasonable fees of counsel).
- (i) The Account Trustee agrees to look solely to Project Co, and not, except as expressly set forth herein, to the Lenders' Agent, the Lenders or Contracting Authority for any claim for indemnification which may arise under this Insurance Trust Agreement.
- (j) The Account Trustee shall be responsible for keeping all appropriate books and records relating to the receipt and disbursement of all money which it receives hereunder.
- (k) If at any time the Account Trustee is served with any judicial or administrative order, judgment, decree, writ or other form of judicial or administrative process which in any way affects the Trust Property held by it hereunder (including, but not limited to, orders of attachment or garnishment or other forms of levies or injunctions or stays relating to the transfer of Trust Property) (each, an "**Order**"), the Account Trustee is authorized to comply therewith in any manner as it or legal counsel of its own choosing deems appropriate. The Account Trustee shall in no way be bound to call for further evidence (whether as to due execution validity or effectiveness, or the jurisdiction of any court, or as to the truth of any fact), and shall not be responsible for any loss that may be occasioned by its failing to do so. If the Account Trustee complies with any Order, the Account Trustee shall not be liable to any of the parties hereto or to any other person or entity even though such Order may be

subsequently modified or vacated or otherwise determined to have been without legal force or effect. If the Account Trustee is served with any Order, it shall forthwith and, in any event, within three Business Days, deliver a copy of such Order to each of the Lenders' Agent, Contracting Authority and Project Co.

- (l) Unless otherwise specifically set forth herein, the Account Trustee shall proceed as soon as practicable to collect any cheques or other collection items at any time deposited hereunder. All such collections shall be subject to the Account Trustee's usual collection practices or terms regarding items received by the Account Trustee for deposit or collection. Except and to the extent provided herein, the Account Trustee shall not be required, or have any duty, to notify any person of any payment or maturity under the terms of any instrument deposited hereunder, nor to take any legal action to enforce payment of any cheque, note or security deposited hereunder, or to exercise any right or privilege which may be afforded to the holder of any such security.
- (m) In the event that the Account Trustee determines that any direction, instruction, notice or other communication given under this Insurance Trust Agreement by the Lenders' Agent or, where the Account Trustee has received a Change of Authorization Notice, Contracting Authority, is ambiguous or uncertain, the Account Trustee may, in its sole discretion, refrain from taking any action other than retaining possession of the Trust Property, unless the Account Trustee has received written instructions, signed by the Lenders' Agent or, if the Account Trustee has received a Change of Authorization Notice, Contracting Authority, which resolve such ambiguity or uncertainty, provided that the Account Trustee shall, forthwith upon determining that such direction, instruction, notice or other communication is ambiguous or uncertain, seek clarification from the Lenders' Agent, or where the Account Trustee has received a Change of Authorization Notice, Contracting Authority, to resolve such ambiguity or uncertainty.
- (n) Prior to receipt of a Change of Authorization Notice by the Account Trustee, any instruction, notice or other communication delivered to the Account Trustee by the Lenders' Agent shall be paramount to and supersede any direction, instruction, notice or other communication from any other party to this Insurance Trust Agreement, and the Account Trustee shall comply with such direction, instruction, notice or other communication from the Lenders' Agent. After the Account Trustee has received a Change of Authorization Notice, any instruction, notice or other communication delivered to the Account Trustee by Contracting Authority shall be paramount to and supersede any direction, instruction, notice or other communication from any other party to this Insurance Trust Agreement, and the Account Trustee shall comply with such direction, instruction, notice or other communication from Contracting Authority.
- (o) Each of the Lenders' Agent and Contracting Authority shall provide to the Account Trustee an incumbency certificate setting out the names and sample signatures of individuals authorized to give instructions to the Account Trustee hereunder. The Account Trustee shall be entitled to rely on each such incumbency certificate until a revised or replacement incumbency certificate is provided to the Account Trustee by the Lenders' Agent or Contracting Authority, as applicable. The Account Trustee shall refuse to act upon any instruction given by the Lenders' Agent or Contracting Authority which is signed by any person other than an individual named in the incumbency certificate provided to the

Account Trustee by the Lenders' Agent or Contracting Authority, as applicable, pursuant to this Section 8(o), as any such incumbency certificate may be amended, supplemented or replaced from time to time.

- (p) The Account Trustee shall be entitled to rely on, and act upon, any direction, instruction, notice or other communication provided to it hereunder which is sent to it by facsimile transmission, provided that any such direction, instruction, notice or other communication is signed by an individual named in the incumbency certificate delivered to the Account Trustee by the Lenders' Agent or Contracting Authority, as applicable, pursuant to Section 8(o).
- (q) The Account Trustee shall retain the right not to act and shall not be liable for refusing to act if, due to a lack of information or for any other reason whatsoever, the Account Trustee, in its sole judgment, determines that such act might cause it to be in non-compliance with any applicable anti-money laundering or anti-terrorist legislation, regulation or guideline. Further, should the Account Trustee, in its sole judgment, determine at any time that its acting under this Insurance Trust Agreement has resulted in its being in non-compliance with any applicable anti-money laundering or anti-terrorist legislation, regulation or guideline, then it shall have the right to resign on 10 days' written notice to Project Co and Contracting Authority, or any shorter period of time as agreed to by Project Co and Contracting Authority, notwithstanding the provisions of Section 8(a) of this Insurance Trust Agreement, provided that (i) the Account Trustee's written notice shall describe the circumstances of such non-compliance; and (ii) if such circumstances are rectified to the Account Trustee's satisfaction within such 10-day period, then such resignation shall not be effective.

9. LENDERS' AGENT AND CONTRACTING AUTHORITY'S RIGHTS TO DIRECT

- (a) Until the first to occur of:
 - (i) the expiry of the Notice Period under the Lenders' Direct Agreement where no Step-In Notice has been delivered thereunder;
 - (ii) the expiry of the Step-In Period under the Lenders' Direct Agreement where:
 - (A) there has been no assignment to a Replacement Project Co;
 - (B) no Replacement Project Agreement has been entered into; or
 - (C) the Appointed Representative has not cured the Project Co Event of Default,

(each, a "**Change of Authorization Event**"), the Lenders' Agent shall, subject to Sections 3 and 4 of this Insurance Trust Agreement, have the exclusive right to direct the Account Trustee with respect to the Insurance Trust Account, the Insurance Policies, the Bonds and the Insurance Proceeds.

- (b) Upon the occurrence of a Change of Authorization Event:
 - (i) the Lenders' Agent shall cease to be entitled, and Contracting Authority shall thenceforth be entitled, to direct the Account Trustee with respect to the Insurance Trust Account, the Insurance Policies, the Bonds and the Insurance Proceeds; and
 - (ii) the Lenders' Agent and Contracting Authority shall jointly provide notice to the Account Trustee (a "**Change of Authorization Notice**") that Contracting Authority shall, as of the date of such Change of Authorization Event, have the exclusive right to direct the Account Trustee with respect to the original copy of the Insurance Trust Account, the Insurance Policies, the Bonds and the Insurance Proceeds.

10. TERMINATION

- (a) Subject to the provisions of Section 10(b), this Insurance Trust Agreement shall remain in full force and effect and be binding in accordance with and to the extent of its terms until:
 - (i) the obligations of Project Co to the Lenders' Agent and the Lenders under the Lending Agreements have been paid and performed in full and the Lenders have no further obligation to make any further advances or other credit accommodations under the Lending Agreements; and
 - (ii) the obligations of Project Co to Contracting Authority have been paid and performed in full.
- (b) The Account Trustee may terminate this Insurance Trust Agreement at any time upon 60 days' prior written notice to the other parties hereto, provided that no termination of this Insurance Trust Agreement by the Account Trustee shall be effective until such time as the Lenders' Agent, Contracting Authority, and Project Co have entered into a replacement Insurance Trust Agreement on the same terms and conditions as this Insurance Trust Agreement with a replacement account trustee satisfactory to the Lenders' Agent, the Lenders and Contracting Authority.

11. ASSIGNMENT

The Account Trustee shall not assign, transfer or otherwise dispose of any of its rights or obligations under this Insurance Trust Agreement without the prior written consent of the Lenders' Agent, Contracting Authority and Project Co.

12. NOTICES

- (a) All notices, requests, demands, instructions, certificates, consents and other communications required or permitted under this Insurance Trust Agreement shall be in writing (whether or not "written notice" or "notice in writing" is specifically required by the applicable provision of this Insurance Trust Agreement) and served by sending the same by registered mail, facsimile or by hand (in each case, with a copy by electronic transmission), as follows:

If to Contracting Authority:

[REDACTED]

Fax No.: **[REDACTED]**

Attn.: **[REDACTED]**

with a copy to:

[REDACTED]

Fax No.: **[REDACTED]**

Attn.: **[REDACTED]**

If to the Lenders' Agent:

[REDACTED]

Email: **[REDACTED]**

Attn: **[REDACTED]**

If to Project Co.:

GCRS Davenport General Partnership

[REDACTED]

Fax No.: **[REDACTED]**

Email: **[REDACTED]**

Attn.: **[REDACTED]**

with a copy to:

Email: **[REDACTED]**

Attn.: **[REDACTED]**

If to the Account Trustee:

[REDACTED]

Fax No.: **[REDACTED]**

Email: **[REDACTED]**

Attn: **[REDACTED]**

- (b) Where any notice is provided or submitted to a Party via facsimile, an original of the notice sent via facsimile shall promptly be sent by regular mail or registered mail. For greater certainty, a notice given via facsimile shall not be invalid by reason only of a Party's failure to comply with this Section 12(b).

- (c) Any Party to this Insurance Trust Agreement may, from time to time, change any of its contact information set forth in Section 12(a) by prior notice to the other Parties, and such change shall be effective on the Business Day that next follows the recipient Party's receipt of such notice unless a later effective date is given in such notice.
- (d) Subject to Sections 12(e), 12(f) and 12(g):
 - (i) a notice given by registered mail shall be deemed to have been received on the third Business Day after mailing;
 - (ii) a notice given by hand delivery shall be deemed to have been received on the day it is delivered; and
 - (iii) a notice given by facsimile shall be deemed to have been received on the day it is transmitted by facsimile.
- (e) If the Party giving the notice knows or ought reasonably to know of difficulties with the postal system which might affect negatively the delivery of mail, any such notice shall not be mailed but shall be made or given by personal delivery or by facsimile transmission in accordance with this Section 12.
- (f) If any notice delivered by hand or transmitted by facsimile is so delivered or transmitted, as the case may be, either on a day that is not a Business Day or on a Business Day after 4:00 p.m. (recipient's local time), then such notice shall be deemed to have been received by such recipient on the next Business Day.
- (g) A notice given by facsimile shall be deemed to have been received by the recipient on the day it is transmitted only if a facsimile transmission report (maintained by the sender) indicates that the transmission of such notice was successful.

13. AMENDMENTS

This Insurance Trust Agreement may not be varied, amended or supplemented except by an agreement in writing signed by duly authorized representatives of the Parties and stating on its face that it is intended to be an amendment, restatement or other modification, as the case may be, to this Insurance Trust Agreement.

14. WAIVER

- (a) No waiver made or given by a Party under or in connection with this Insurance Trust Agreement shall be binding or effective unless the waiver is in writing, signed by an authorized representative of the Party giving such waiver, and delivered by such Party to the other Parties. No waiver made with respect to any right, power or remedy in one instance will be deemed to be a waiver with respect to any other instance involving the exercise of such right, power, or remedy or with respect to any other right, power, or remedy.

- (b) Failure by any Party to exercise any of its rights, powers or remedies hereunder or its delay to do so shall not constitute a waiver of those rights, powers or remedies. The single or partial exercise of a right, power or remedy shall not prevent its subsequent exercise or the exercise of any other right, power or remedy.

15. RELATIONSHIP BETWEEN THE PARTIES

The Parties are independent contractors. This Insurance Trust Agreement is not intended to and does not create or establish between the Parties any relationship as partners, joint venturers, employer and employee, master and servant, or, except as provided in this Insurance Trust Agreement, of principal and agent.

16. ENTIRE AGREEMENT

Except where provided otherwise in this Insurance Trust Agreement, this Insurance Trust Agreement constitutes the entire agreement between the Parties in connection with its subject matter and supersedes all prior representations, communications, negotiations and understandings, whether oral, written, express or implied, concerning the subject matter of this Insurance Trust Agreement.

17. SEVERABILITY

Each provision of this Insurance Trust Agreement shall be valid and enforceable to the fullest extent permitted by law. If any provision of this Insurance Trust Agreement is declared invalid, unenforceable or illegal by the courts of a competent jurisdiction, such provision may be severed and such invalidity, unenforceability or illegality shall not prejudice or affect the validity, enforceability and legality of the remaining provisions of this Insurance Trust Agreement. If any such provision of this Insurance Trust Agreement is invalid, unenforceable or illegal, the Parties shall, acting in good faith, promptly negotiate new provisions to eliminate such invalidity, unenforceability or illegality and to restore this Insurance Trust Agreement as near as possible to its original intent and effect.

18. ENUREMENT

This Insurance Trust Agreement shall enure to the benefit of, and be binding on, each of the Parties and their respective successors and permitted transferees and assigns.

19. GOVERNING LAW AND JURISDICTION

- (a) This Insurance Trust Agreement shall be governed by and construed in accordance with the laws of Ontario and the laws of Canada applicable therein and shall be treated in all respects as an Ontario contract, without regard to conflict of laws principles.
- (b) The Parties agree that the courts of the Province of Ontario and all courts competent to hear appeals therefrom shall have exclusive jurisdiction to hear and settle any action, suit, proceeding or dispute in connection with this Insurance Trust Agreement and hereby irrevocably attorn to the exclusive jurisdiction of such courts.

- (c) Nothing in this Insurance Trust Agreement affects the rights, protections and immunities of the Crown under the *Proceedings Against the Crown Act* (Ontario).

20. CONTRACTING AUTHORITY DESIGNATE

At any time and from time to time, the Crown may designate any ministry, branch, agency, division, department or office of the Government of Ontario to carry out administrative responsibility for the rights and obligations of Contracting Authority under this Insurance Trust Agreement and Project Co, the Lenders' Agent and the Account Trustee may deal exclusively with the designated person in respect of all such matters and is entitled to rely on the actions, directions, requests, notices, consents, approvals, waivers, comments relating to the review of documentation and other administrative matters and decisions determined by such designated person from time to time, until the Crown has notified Project Co, the Lenders' Agent and the Account Trustee in writing that such designated person is no longer the person designated by the Crown hereunder and such notice shall have effect on the later of the date of delivery of such notice and the date specified in the written notice. The Crown shall advise Project Co, the Lenders' Agent and the Account Trustee in writing of any designation hereunder. The rights and obligations of the parties to this Insurance Trust Agreement shall be in no way affected by reason of any such designation. Project Co, the Lenders' Agent and the Account Trustee acknowledge the right of the Crown to delegate administrative responsibilities hereunder as set forth in this Section 20.

21. FURTHER ASSURANCE

Each Party shall do all things, from time to time, and execute all reasonable further documents necessary to give full effect to this Insurance Trust Agreement.

22. LANGUAGE OF AGREEMENT

Each Party acknowledges having requested and being satisfied that this Insurance Trust Agreement and related documents be drawn in English. Chacune des parties reconnaît avoir demandé que ce document et ses annexes soient rédigés en anglais et s'en déclare satisfaite.

23. COUNTERPARTS

This Insurance Trust Agreement may be executed in one or more counterparts. Any single counterpart or a set of counterparts executed, in either case, by all the Parties shall constitute a full, original and binding agreement for all purposes. Counterparts may be executed either in original or faxed form provided that any Party providing its signature in faxed form shall promptly forward to such Party an original signed copy of this Insurance Trust Agreement which was so faxed.

24. JOINT AND SEVERAL

IO, as Crown agent, and Metrolinx, as Crown agency, shall be liable, on a joint and several basis, for all of the obligations of Contracting Authority under this Insurance Trust Agreement and for each covenant of the other under this Insurance Trust Agreement.

25. COPYRIGHT NOTICE

The Parties acknowledge that Queen’s Printer for Ontario is the exclusive owner of the copyright in the Project Agreement and this Insurance Trust Agreement.

IN WITNESS WHEREOF the Parties have executed this Insurance Trust Agreement as of the date first above written.

ONTARIO INFRASTRUCTURE AND LANDS CORPORATION, a Crown agent, continued under the *Ontario Infrastructure and Lands Corporation Act, 2011*

Per: _____
Name: [REDACTED]
Title: [REDACTED]

I have authority to bind the corporation

METROLINX

Per: _____
Name: [REDACTED]
Title: [REDACTED]

Per: _____
Name: [REDACTED]
Title: [REDACTED]

I/We have authority to bind the corporation

[REDACTED]

Per: _____
Name: [REDACTED]
Title: [REDACTED]

Per: _____
Name: [REDACTED]
Title: [REDACTED]

I/We have authority to bind the corporation

GCRS DAVENPORT GENERAL PARTNERSHIP,
by its partners:

[REDACTED]

Per: _____

Name: **[REDACTED]**

Title: **[REDACTED]**

I have authority to bind the corporation.

[REDACTED]

Per: _____

Name: **[REDACTED]**

Title: **[REDACTED]**

I have authority to bind the corporation.

[REDACTED]

Per: _____
Name: **[REDACTED]**
Title: **[REDACTED]**

Per: _____
Name: **[REDACTED]**
Title: **[REDACTED]**

I/We have authority to bind the corporation

SCHEDULE 31

PROJECT CO INFORMATION

[REDACTED]

**SCHEDULE 32
FINANCIAL MODEL
[REDACTED]**

SCHEDULE 33

WORKS REPORT REQUIREMENTS

1. The Works Report shall include the following:
 - (a) an executive summary, describing the general status of the Works;
 - (b) detailed status of the Works, including,
 - (i) a narrative detailing the progress of:
 - (A) New Metrolinx Infrastructure, including the Rail Grade Separation Works; and
 - (B) all New Third Party Infrastructure including New Routine Third Party Infrastructure;
 - (ii) a narrative detailing progress of design and review;
 - (iii) a narrative on contemplated innovations, where applicable; and
 - (iv) a narrative detailing progress and issues for,
 - (A) communications and public engagement;
 - (B) traffic and transit management (including Access Management Plan and road detour and lane closures);
 - (C) construction progress related to overall phasing of the site (including a site map illustrating progress);
 - (D) flagging resources;
 - (E) progress of utility works;
 - (F) demolition and removals;
 - (G) health and safety, including,
 - (I) a threat and vulnerability log;
 - (II) the total number of hours worked for all persons on Site;
 - (III) the total number of critical injuries or fatalities;
 - (IV) the total number of injuries to any member of the public;

- (V) the total number of incidents involving medical aid or health care (as defined by the *Workplace Safety and Insurance Act* (Ontario));
 - (VI) the total number of incidents involving first aid (as defined by the *Workplace Safety and Insurance Act* (Ontario));
 - (VII) the total number of incidents involving damage to Metrolinx property, infrastructure, adjacent property and/or mobile equipment;
 - (VIII) the total number of near misses (no damage to property or persons);
 - (IX) the total number of incidents resulting in lost time;
 - (X) all correspondence related to MOL or MOE visits; and
 - (XI) security and emergency management;
- (v) status update of all Permits, Licences, Approvals and Agreements necessary for the completion of the Works;
 - (vi) environmental monitoring and compliance status;
 - (vii) all commissioning, occupancy and completion, including
 - (A) commissioning status;
 - (B) training status;
 - (C) occupancy status;
 - (D) deficiency review/rectification status; and
 - (E) completion status;
 - (c) plans for Works scheduled in the forthcoming reporting period;
 - (d) goals for next reporting period (such as progress on activities, resolution of issues);
 - (e) progress photos;
 - (f) contractual outstanding decisions and description of any disputes related to the Works and action taken place over the last month to resolve such disputes;
 - (g) sustainability compliance status, including sustainability measures implemented or to be implemented;
 - (h) quality assurance and quality control including,

- (i) status of Design Quality Management Plan, Construction Quality Management Plan, the Access Quality Management Plan and the Environmental Quality Management Plan;
- (ii) a table setting out and responding to items of Non-Conformance and deficiencies in ongoing Works as identified by Contracting Authority or Project Co or both;
- (iii) status of Design Certificates and Construction Certificates;
- (iv) update of quality control and quality assurance activities and personnel responsible;
- (v) monthly Quality Management System reports, Quality Audit reports and summary information from the Non-Conformance Tracking System (all as described in Schedule 11 - Quality Management); and
- (vi) status of Internal Quality Audits and External Quality Audits;
- (i) organization and staffing changes, deletions and additions for Project Co and all Project Co Parties;
- (j) status of all Works Submittals pursuant to the requirements of the Project Agreement;
- (k) Subcontract status, including,
 - (i) consultants;
 - (ii) Subcontracts awarded;
 - (iii) tenders;
 - (iv) apprenticeships; and
 - (v) labour report (average workforce), including number of direct jobs created overall;
- (l) financial status, including,
 - (i) progress and Variations status;
 - (ii) insurance summary;
 - (iii) Construction Contractor default status;
 - (iv) current cash flow status (capital cost components) for both actual and projected expenditure (capital cost components), from Financial Close represented monthly, quarterly and annually and excluding Variations;
 - (v) 12-month (minimum) financial forecast including all Project Co costs; and

- (vi) the Construction Period Deduction information pursuant to Schedule 21 – Liquidated Damages and Construction Enforcement Regime;
 - (m) risk management, including,
 - (i) updated risk register;
 - (ii) risk response plans requiring action from Contracting Authority;
 - (iii) claims;
 - (iv) liens;
 - (v) environmental issues;
 - (vi) labour;
 - (vii) market conditions;
 - (viii) outstanding disputes;
 - (ix) safety and security;
 - (x) operational risks;
 - (xi) Stakeholder risks; and
 - (xii) other risks; and
 - (n) a summary of Maintenance Services as described in Schedule 15 – Output Specifications.
2. Project Co shall address comments from Contracting Authority on each previous month’s reporting in subsequent reports, and will be required to provide a resolution table to illustrate how Contracting Authority comments have been addressed.

TRAIN	1	1		
DATE / DATE	Until/Jusqu'au April 27, 2019	Starting/Début May 1, 2019		
DAYS / JOURS	1234567	1234567		
Toronto, ON ET / HE (L) DP	22:00	09:30	DAY / JOUR 1 - 1234567	
Washago 42	00:40	12:10		
Parry Sound (CP Station / Gare CP) 42	02:42	14:12		
Sudbury Jct.*	05:12	16:42		
Capreol (L) AR DP	05:37	17:07		
Laforest 42	06:07	17:37		
McKee's Camp 42	07:03	18:33		
Felix 42	07:16	18:46		
Ruel 42	07:36	19:06		
Westree 42	07:43	19:13		
Gogama 42	08:00	19:30		
Foleyet 42	08:33	20:03		
Foleyet 42	10:59	22:29		
Elsas 42	11:53	23:23		
Oba 42	13:53	01:23		
Hornepayne AR DP	14:44	02:14		DAY / JOUR 2 - 1234567
Hillsport 42	15:24	02:54		
Caramat 42	16:20	03:50		
Longlac 42	17:10	04:40		
Nakina 42	17:49	05:19		
Auden 42	18:28	05:58		
Ferland 42	19:34	07:04		
Mud River 42	20:11	07:41		
Armstrong 42	20:20	07:50		
Collins ET / HE 42	21:32	09:02		
Allanwater Bridge CT / HC 42	22:02	09:32		
Flindt Landing 42	21:41	09:11		
Savant Lake 42	21:57	09:27		
Savant Lake 42	22:14	09:44		
Sioux Lookout AR DP	23:40	11:10	DAY / JOUR 2 - 1234567	
Richan 42	00:10	11:40		
Red Lake Road 42	01:20	12:50		
Canyon 42	01:56	13:26		
Farlane 42	02:25	13:55		
Redditt 42	03:02	14:32		
Minaki 42	03:38	15:08		
Ottermere 42	03:59	15:29		
Ottermere 42	04:16	15:46		
Malachi 42	04:22	15:52		
Copelands Landing 42	04:24	15:54		
Rice Lake, ON 42	04:27	15:57		
Winnitoba, MB 42	04:41	16:11		

TRAIN	1	1	3	NEW NOUVEAU
DATE / DATE	Until/Jusqu'au April 29, 2019	Starting/Début May 2, 2019	May 3, 2019 to Oct. 11, 2019	
DAYS / JOURS	1234567	1234567	1234567	
Ophir 42	04:46	16:16	DAY / JOUR 2 - 1234567	DAY / JOUR 2 - 1234567
Brereton Lake 42	05:04	16:34		
Elma 42	05:25	16:55		
Winnipeg, MB CT / HC (L) AR DP	08:00	19:30		
Portage la Prairie 42	10:00	21:30		
Rivers, MB 42	11:34	23:04		
Melville, SK N1	13:31	01:31		
Melville, SK N1	17:34	06:04		
Watrous N1	20:24	08:54		
Saskatoon N1 (L) AR DP	22:40	10:50		
Biggar N1	23:20	11:50		
Biggar N1	01:09	13:39		
Unity, SK N1 CT / HC 42	02:14	14:44		
Wainwright, AB MT / HR 42	04:03	16:33		
Viking 42	04:56	17:26		
Edmonton (L) AR DP	08:22	20:50		
Edmonton	09:37	00:01		
Evansburg 42	11:05	01:29		
Edson 42	12:28	02:52		
Hinton 42	13:34	03:58		
Jasper, AB MT / HR (L) AR DP	16:00	06:30		
Jasper, AB MT / HR	19:30	09:30		
Valemount, BC PT / HP 42	20:50	10:50		
Blue River 42	23:36	13:36		
Clearwater 42	01:45	15:45		
Kamloops North AR DP	04:28	18:28		
Kamloops North	05:03	19:03		
Ashcroft (CN Station / Gare CN) 42	06:49	20:49		
Boston Bar 42	10:06	00:06		
Hope 42	12:01	02:01		
Chilliwack 42	12:48	02:48		
Abbotsford 42	13:56	03:56		
Vancouver, BC PT / HP AR	18:00	08:00	DAY / JOUR 4 - 1234567	DAY / JOUR 4 - 1234567
Vancouver, BC PT / HP	00:01	00:01		
Vancouver, BC PT / HP	01:29	01:29		
Vancouver, BC PT / HP	02:52	02:52		
Vancouver, BC PT / HP	03:58	03:58		
Vancouver, BC PT / HP	06:30	06:30		
Vancouver, BC PT / HP	09:30	09:30		
Vancouver, BC PT / HP	10:50	10:50		
Vancouver, BC PT / HP	13:36	13:36		
Vancouver, BC PT / HP	15:45	15:45		
Vancouver, BC PT / HP	18:28	18:28		
Vancouver, BC PT / HP	19:03	19:03		
Vancouver, BC PT / HP	20:49	20:49		
Vancouver, BC PT / HP	00:06	00:06		
Vancouver, BC PT / HP	02:01	02:01		
Vancouver, BC PT / HP	02:48	02:48		
Vancouver, BC PT / HP	03:56	03:56		
Vancouver, BC PT / HP	08:00	08:00		

Please refer to our website for the status of the service and the latest version of the schedule. / Veuillez vous référer à notre site Web pour connaître l'état du service et la dernière version de l'horaire en vigueur.

42 For a stop at this station, reservations are required at least 40 minutes before the train departure from the last station where a passenger list (L) is issued. / Pour un arrêt à cette gare, les réservations sont requises au moins 40 minutes avant le départ du train de la dernière gare où une liste de voyageurs (L) est émise.

* Sudbury Jct., ON, is 10 km from Sudbury, ON. No shuttle service. / Sudbury Jct., Ontario est située à 10 km de Sudbury, Ontario. Aucun service de navette.

Checked baggage is available on this train at certain stations only. For more information, please call VIA Rail (1 888 842-7245) or visit our website (viarail.ca). / L'enregistrement des bagages est offert pour ce train à certaines gares seulement. Pour plus d'information, veuillez appeler VIA Rail (1 888 842-7245) ou visiter notre site Web (viarail.ca).

N1 Saskatchewan: Always standard time. / Saskatchewan : Toujours l'heure normale.



A Division of METROLINX

Form 660 – No. 35





Effective at 0300



REVISION



September 24, 2018









WESTWARD		LAKESHORE - WEEKDAY									
Bus Connections											
CYCLE FROM				WB	WB			WRMF	LI		BR
STATIONS	Mile			E260U	E250U			703	861		780
GO SUBDIVISION											
OSHAWA NORTH	11.6							05:07			
WHITBY NORTH	8.9							05:13			
AJAX NORTH	3.5							05:21			
PICKERING NORTH	1.0							05:26			
KINGSTON SUBDIVISION											
PICKERING SOUTH	312.9									
DURHAM JCT	313.9							(05:28)			
ROUGE HILL	317.3							05:34			
GUILDWOOD	321.2							05:41			
EGLINTON	323.2							05:46			
SCARBOROUGH	325.2							05:51	(06:11)		
DANFORTH	328.6							05:56	06:15		
USRC				From	From				From		From
SCOTT ST.	333.3			Oakville	Oakville				Uxbridge		Newmarket
TORONTO	333.8	Sub	Sub	(06:05)	Sub	Sub
CYCLE TO				E260	E250				E268		E258
CYCLE FROM		WB	WB	E260U	E250U	WB	WB		861	WB	780
TORONTO	0.0	04:45	04:55	06:13	(06:33)	(06:43)
JOHN ST.	0.5			To	To			To		To
USRC				Weston	Weston				Weston		Weston
				Sub	Sub				Sub		Sub
OAKVILLE SUBDIVISION											
EXHIBITION	2.0							06:19			
MIMICO	6.7							06:27			
CANPA	8.4	(04:16)	(04:46)			(05:27)	(05:57)		(06:44)	
LONG BRANCH	9.6	↓	↓			↓	↓	06:32		↓	
PORT CREDIT	12.8							06:38			
CLARKSON	16.7							06:44			
OAKVILLE	21.4							06:51			
BRONTE	24.7							06:57			
APPLEBY	27.9							07:03			
BURLINGTON	31.5	↓	↓			(06:07)	(06:37)	07:10		↓	
ALDRESHOT	34.6	(04:53)	(05:23)					07:16		(07:36)	
HAMILTON JCT	37.3										
WEST HARBOUR	39.3										
CP HAMILTON SUBDIVISION											
DESJARDINS	60.1										
MAIN	58.9										
LOCKE	58.4										
PARK	57.6										
HAMILTON	57.5										
HAMILTON LAYOVER											
GRIMSBY SUB											
LEWIS RD LAYOVER	32.7										
CYCLE TO		E700	E900	E260	E250	E702	E902	703	E268	E708	E258
CYCLE FROM		700	900	260	250	702	902	706	268	708	MA
Bus Connections											













WESTWARD		LAKESHORE - WEEKDAY									
Bus Connections											
CYCLE FROM		WRMF	WRMF	MI	LI	WRMF	E150	WRMF	HA	GE	
STATIONS		903	421	148	863	705	150	423	492	204	
Mile											
GO SUBDIVISION											
OSHAWA NORTH	11.6	05:37	06:03			06:12		06:33			
WHITBY NORTH	8.9	05:43	06:09			06:18		06:39			
AJAX NORTH	3.5	05:51	06:17			06:26		06:47			
PICKERING NORTH	1.0	05:56	06:22			06:31		06:52			
KINGSTON SUBDIVISION											
PICKERING SOUTH	312.9					
DURHAM JCT	313.9	(05:58)				(06:33)					
ROUGE HILL	317.3	06:04				06:39					
GUILDWOOD	321.2	06:11				06:46					
EGLINTON	323.2	06:16				06:51					
SCARBOROUGH	325.2	06:21			(06:51)	06:56					
DANFORTH	328.6	06:26			From Uxbridge Sub	07:01					
USRC											
SCOTT ST.	333.3	(06:35)	(06:50)	From Galt Sub		(07:10)	From Galt Sub	(07:20)	From Oakville Sub	From Weston Sub	
TORONTO	333.8	06:40	06:55	07:00	07:08	07:15	07:24	07:25	07:30	07:27
CYCLE TO		551	E148D	E122	553	555	E492W	E204W
CYCLE FROM			421	148	863	150	423	492	204	WB
TORONTO	0.0	06:43	07:00	(07:06)	(07:18)	07:18	07:34	07:30	(07:35)	(07:37)
JOHN ST.	0.5		To Kingston Sub	Spare at Scott St. (07:23)			Change ends at Scott St.		
OAKVILLE SUBDIVISION											
EXHIBITION	2.0	06:50				07:25					
MIMICO	6.7	06:58				07:33			(07:55)	(08:10)	
CANPA	8.4									(07:43)
LONG BRANCH	9.6	07:04				07:39					
PORT CREDIT	12.8	07:10				07:45					
CLARKSON	16.7	07:16				07:51					
OAKVILLE	21.4	07:24	07:26			07:59		07:56			(08:22)
BRONTE	24.7	07:30				08:05					
APPLEBY	27.9	07:37				08:12	08:17				
BURLINGTON	31.5	07:44				08:19					
ALDRESHOT	34.6	07:51				08:26					
HAMILTON JCT	37.3										
WEST HARBOUR	39.3										
CP HAMILTON SUBDIVISION											
DESJARDINS	60.1										
MAIN	58.9										
LOCKE	58.4										
PARK	57.6										
HAMILTON	57.5										
HAMILTON LAYOVER											
GRIMSBY SUB											
LEWIS RD LAYOVER		32.7									
		903	551	E148D	E122	705	553	555	E492W	E204W	E908
CYCLE TO		472	904	DY	E123W	710	474	906	WB	WB	908
Bus Connections											

WESTWARD		LAKESHORE - WEEKDAY									
Bus Connections											
CYCLE FROM		LI	E832	WRMF	MI	AE	GE	WRMF	LI	HA	KW
STATIONS	Mile	865	832	905	152	786	206	425	867	494	208
GO SUBDIVISION											
OSHAWA NORTH	11.6			06:42				07:03			
WHITBY NORTH	8.9			06:48				07:09			
AJAX NORTH	3.5			06:56				07:17			
PICKERING NORTH	1.0			07:01				07:22			
KINGSTON SUBDIVISION											
PICKERING SOUTH	312.9									
DURHAM JCT	313.9			(07:03)							
ROUGE HILL	317.3			07:09							
GUILDWOOD	321.2			07:16							
EGLINTON	323.2			07:21							
SCARBOROUGH	325.2	(07:21)		07:26					(07:38)		
DANFORTH	328.6	07:28		07:31					07:48		
USRC											
SCOTT ST.	333.3	Sub	From Bala Sub	(07:40)	From Galt Sub	From Newmkt Sub	From Weston Sub	(07:50)	From Uxbridge Sub	From Oakville Sub	From Weston Sub
TORONTO	333.8	07:40	07:41	07:45	07:45	07:47	07:52	07:55	08:00	08:00	
CYCLE TO		E865B	E832W	E152D	E786W	E206W	E425B	607	E494W	E208Y
CYCLE FROM		865	832	152	786	206	425	867	494	208
TORONTO	0.0	(07:45)	(07:46)	07:48	(07:50)	(07:52)	(07:57)	(08:00)	08:08	(08:05)	(08:06)
JOHN ST.	0.5	To BNY (07:55)		To Kingston Sub	Change ends at Scott St.	Change ends at Scott St.	To BNY (08:10)		Change ends at Scott St.	
OAKVILLE SUBDIVISION											
EXHIBITION	2.0			07:55					08:12		
MIMICO	6.7		(08:06)	08:03		(08:30)	(08:35)		08:23	(08:40)	(08:36)
CANPA	8.4							08:28		
LONG BRANCH	9.6			08:09							
PORT CREDIT	12.8			08:15							
CLARKSON	16.7			08:21							
OAKVILLE	21.4			08:29							
BRONTE	24.7			08:35							
APPLEBY	27.9			08:42							
BURLINGTON	31.5			08:49							
ALDRESHOT	34.6			08:56							
HAMILTON JCT	37.3										
WEST HARBOUR	39.3										
CP HAMILTON SUBDIVISION											
DESJARDINS	60.1										
MAIN	58.9										
LOCKE	58.4										
PARK	57.6										
HAMILTON	57.5										
HAMILTON LAYOVER											
GRIMSBY SUB											
LEWIS RD LAYOVER	32.7										
CYCLE TO		E865B	E832W	905	E152D	E786W	E206W	E425B	607	E494W	E208Y
CYCLE FROM		BNY	WB	910	DY	WB	WB	BNY	WB	WB	MY
Bus Connections											





WESTWARD		LAKESHORE - WEEKDAY									
Bus Connections											
CYCLE FROM		AE	E707	E834	AE	552	700	LI	AE	E836	Cherry St
STATIONS		788	707	834	790	427	429	869	792	836	E269
GO SUBDIVISION											
OSHAWA NORTH	11.6		07:13				07:33				
WHITBY NORTH	8.9		07:19				07:39				
AJAX NORTH	3.5		07:27				07:47				
PICKERING NORTH	1.0		07:32				07:52				
KINGSTON SUBDIVISION											
PICKERING SOUTH	312.9					07:36					
DURHAM JCT	313.9									
ROUGE HILL	317.3					07:46					
GUILDWOOD	321.2					07:55					
EGLINTON	323.2					08:00					
SCARBOROUGH	325.2					08:05		(08:10)			
DANFORTH	328.6					08:11		08:20			
USRC		From Newmkt Sub	↓	From Bala Sub	From Newmkt Sub		↓	From Uxbridge Sub	From Newmkt Sub	From Bala Sub	From Cherry St
SCOTT ST.	333.3		(08:00)			(08:20)	(08:20)				(08:35)
TORONTO	333.8	08:03	08:05	08:13	08:19	08:23	08:25	08:32	08:33	08:43	(08:43)
CYCLE TO		E788W	E834B	E790X	609	E429B	E869B	E792W	E836B	269
CYCLE FROM		788	834	790	427	429	869	792	836	E269
TORONTO	0.0	(08:13)	08:13	(08:18)	(08:24)	08:28	(08:30)	(08:37)	08:43	(08:48)	08:55
JOHN ST.	0.5		To BNY (08:33)	To Kingston Sub	↓	To BNY (08:40)	To BNY (08:47)	↓	To BNY (08:58)	To Weston Sub
OAKVILLE SUBDIVISION											
EXHIBITION	2.0		08:20			08:35					
MIMICO	6.7	(08:38)	08:28			08:43		(09:13)			
CANPA	8.4				08:48					
LONG BRANCH	9.6		08:34								
PORT CREDIT	12.8		08:40								
CLARKSON	16.7		08:46								
OAKVILLE	21.4		08:54								
BRONTE	24.7		09:00								
APPLEBY	27.9		09:07								
BURLINGTON	31.5		09:14								
ALDRESHOT	34.6		09:21								
HAMILTON JCT	37.3										
WEST HARBOUR	39.3										
CP HAMILTON SUBDIVISION											
DESJARDINS	60.1										
MAIN	58.9										
LOCKE	58.4										
PARK	57.6										
HAMILTON	57.5										
HAMILTON LAYOVER											
GRIMSBY SUB											
LEWIS RD LAYOVER	32.7										
CYCLE TO		E788W	707	E834B	E790X	609	E429B	E869B	E792W	E836B	269
CYCLE FROM		WB	712	BNY	WRMF	WB	BNY	BNY	WB	BNY	KW
Bus Connections											

WESTWARD		LAKESHORE - WEEKDAY									
Bus Connections											
CYCLE FROM		550	E162	900	GE	LI	E472	E164	KW	E838	554
STATIONS		907	162	431	212	871	472	164	214	838	709
GO SUBDIVISION											
OSHAWA NORTH	11.6	07:42		08:03							08:12
WHITBY NORTH	8.9	07:48		08:09							08:18
AJAX NORTH	3.5	07:56		08:17							08:26
PICKERING NORTH	1.0	08:01		08:22							08:31
KINGSTON SUBDIVISION											
PICKERING SOUTH	312.9										
DURHAM JCT	313.9	(08:03)									(08:33)
ROUGE HILL	317.3	08:09									08:39
GUILDWOOD	321.2	08:16									08:46
EGLINTON	323.2	08:21									08:51
SCARBOROUGH	325.2	08:26				(08:38)					08:56
DANFORTH	328.6	08:31				08:50					09:01
USRC											
SCOTT ST.	333.3	(08:40)	From Galt Sub	(08:50)	From Weston Sub	From Uxbridge Sub	From Oakville Sub	From Galt Sub	From Weston Sub	From Bala Sub	(09:10)
TORONTO	333.8	08:45	08:48	08:55	08:50	09:00	09:00	09:00	09:13	09:13	09:15
CYCLE TO		E162Y	E431W	499	E871Y	E472W	E164Y	E214W	E838W
CYCLE FROM		162	431	212	871	472	164	214	838
TORONTO	0.0	08:48	(08:58)	(09:00)	09:03	(09:05)	(09:10)	(09:05)	(09:23)	(09:18)	09:18
JOHN ST.	0.5			Change ends at Scott St.		
USRC											
OAKVILLE SUBDIVISION											
EXHIBITION	2.0	08:55	↓	↓	09:10	↓	↓	↓	↓	↓	09:25
MIMICO	6.7	09:03	(09:25)	(09:20)	09:18	(09:30)	(09:35)	(09:35)	(09:43)	(09:43)	09:33
CANPA	8.4
LONG BRANCH	9.6	09:09			09:24						09:39
PORT CREDIT	12.8	09:15			09:30						09:45
CLARKSON	16.7	09:21			09:36						09:51
OAKVILLE	21.4	09:29			09:44						09:59
BRONTE	24.7	09:35									10:05
APPLEBY	27.9	09:42									10:12
BURLINGTON	31.5	09:49									10:19
ALDRERSHOT	34.6	09:56									10:26
HAMILTON JCT	37.3										
WEST HARBOUR	39.3										
CP HAMILTON SUBDIVISION											
DESJARDINS	60.1										
MAIN	58.9										
LOCKE	58.4										
PARK	57.6										
HAMILTON	57.5										
HAMILTON LAYOVER											
GRIMSBY SUB											
LEWIS RD LAYOVER	32.7										
CYCLE TO		907	E162Y	E431W	499	E871Y	E472W	E164Y	E214W	E838W	709
CYCLE FROM		912	MY	WB	504	MY	WB	MY	WB	WB	714
Bus Connections											





WESTWARD		LAKESHORE - WEEKDAY											
Bus Connections													
CYCLE FROM		MA	702	E474	LI	BR	556	BR	LI	704	902		
STATIONS		Mile	258	909	474	873	796	433	798	875	711	503	
GO SUBDIVISION													
OSHAWA NORTH	11.6		08:33					08:47			09:08	09:23	
WHITBY NORTH	8.9		08:39					08:53			09:14	09:29	
AJAX NORTH	3.5		08:47					09:01			09:22	09:37	
PICKERING NORTH	1.0		08:52					09:06			09:28	09:43	
KINGSTON SUBDIVISION													
PICKERING SOUTH	312.9		↓								
DURHAM JCT	313.9							(09:08)			(09:30)	(09:45)	
ROUGE HILL	317.3							09:14			09:35	09:50	
GUILDWOOD	321.2							09:21			09:42	09:57	
EGLINTON	323.2							09:26			09:47	10:02	
SCARBOROUGH	325.2					(09:08)		09:31		(10:13)	09:52	10:07	
DANFORTH	328.6					09:20		09:36		10:25	09:57	10:12	
USRC													
SCOTT ST.	333.3	From Weston Sub		(09:20)	From Oakville Sub	From Uxbridge Sub	From Newmarket Sub			From Newmarket Sub	From Uxbridge Sub	(10:05)	(10:20)
TORONTO	333.8	09:05		09:25	09:28	09:30	09:33	09:50	10:33	10:35	10:11	10:26	
CYCLE TO		E258W	E474Y	781	271	501	273	783	506		
CYCLE FROM		258	474	873	796	433	798	875	503		
TORONTO	0.0	(09:25)	09:43	(09:33)	09:40	09:48	09:58	10:53	10:40	10:13	11:33		
JOHN ST.	0.5		Change ends at Scott St.	To Newmarket Sub	To Weston Sub	To Weston Sub	To Newmarket Sub	To Kingston Sub		
OAKVILLE SUBDIVISION													
EXHIBITION	2.0		09:50	↓			10:05			10:20			
MIMICO	6.7	(09:45)	09:58	(09:58)			10:13			10:28			
CANPA	8.4				
LONG BRANCH	9.6		10:04				10:19			10:34			
PORT CREDIT	12.8		10:10				10:25			10:40			
CLARKSON	16.7		10:16				10:31			10:46			
OAKVILLE	21.4		10:24				10:39			10:54			
BRONTE	24.7		10:30							11:00			
APPLEBY	27.9		10:37							11:07			
BURLINGTON	31.5		10:44							11:14			
ALDRESHOT	34.6		10:51							11:21			
HAMILTON JCT	37.3												
WEST HARBOUR	39.3												
CP HAMILTON SUBDIVISION													
DESJARDINS	60.1												
MAIN	58.9												
LOCKE	58.4												
PARK	57.6												
HAMILTON	57.5												
GRIMSBY SUB													
LEWIS RD LAYOVER	32.7												
CYCLE TO		E258W	909	E474Y	781	271	501	273	783	711	506		
CYCLE FROM		WB	914	MY	800	272	508	274	802	716	517		
Bus Connections													



WESTWARD		LAKESHORE - WEEKDAY										
Bus Connections												
CYCLE FROM		904	906	706	E122	708	LI	781	908	500	710	
STATIONS		911	505	713	E123W	507	877	800	913	509	715	
Mile												
GO SUBDIVISION												
OSHAWA NORTH	11.6	09:38	09:53	10:08		10:23			10:38	10:53	11:08	
WHITBY NORTH	8.9	09:44	09:59	10:14		10:29			10:44	10:59	11:14	
AJAX NORTH	3.5	09:52	10:07	10:22		10:37			10:52	11:07	11:22	
PICKERING NORTH	1.0	09:58	10:13	10:28		10:43			10:58	11:13	11:28	
KINGSTON SUBDIVISION												
PICKERING SOUTH	312.9	
DURHAM JCT	313.9	(10:00)	(10:15)	(10:30)		(10:45)			(11:00)	(11:15)	(11:30)	
ROUGE HILL	317.3	10:05	10:20	10:35		10:50			11:05	11:20	11:35	
GUILDWOOD	321.2	10:12	10:27	10:42		10:57			11:12	11:27	11:42	
EGLINTON	323.2	10:17	10:32	10:47		11:02			11:17	11:32	11:47	
SCARBOROUGH	325.2	10:22	10:37	10:52		11:07	(11:10)		11:22	11:37	11:52	
DANFORTH	328.6	10:27	10:42	10:57		11:12			11:27	11:42	11:57	
USRC												
SCOTT ST.	333.3	(10:35)	(10:50)	(11:05)	(11:07)	(11:20)	From Uxbridge Sub	From Newmarket Sub	(11:35)	(11:50)	(12:05)	
TORONTO	333.8	10:41	10:56	11:11		11:26	11:27	11:33	11:41	11:56	12:11	
CYCLE TO			510	785	275	
CYCLE FROM						507	877	800				
TORONTO	0.0	10:43	10:58	11:13		12:33	11:40	11:53	11:43	11:58	12:13	
JOHN ST.	0.5		To Kingston Sub	To Newmarket Sub	To Weston Sub	
OAKVILLE SUBDIVISION												
EXHIBITION	2.0	10:50	11:05	11:20					11:50	12:05	12:20	
MIMICO	6.7	10:58	11:13	11:28	(11:30)				11:58	12:13	12:28	
CANPA	8.4	
LONG BRANCH	9.6	11:04	11:19	11:34					12:04	12:19	12:34	
PORT CREDIT	12.8	11:10	11:25	11:40					12:10	12:25	12:40	
CLARKSON	16.7	11:16	11:31	11:46					12:16	12:31	12:46	
OAKVILLE	21.4	11:24	11:39	11:54					12:24	12:39	12:54	
BRONTE	24.7	11:30		12:00					12:30		13:00	
APPLEBY	27.9	11:37		12:07					12:37		13:07	
BURLINGTON	31.5	11:44		12:14					12:44		13:14	
ALDRESHOT	34.6	11:51		12:21					12:51		13:21	
HAMILTON JCT	37.3											
WEST HARBOUR	39.3											
CP HAMILTON SUBDIVISION												
DESJARDINS	60.1											
MAIN	58.9											
LOCKE	58.4											
PARK	57.6											
HAMILTON	57.5											
HAMILTON LAYOVER												
GRIMSBY SUB												
LEWIS RD LAYOVER	32.7											
CYCLE TO		911	505	713	E123W	510	785	275	913	509	715	
CYCLE FROM		916	512	718	WB	569	804	276	918	516	720	
Bus Connections												





WESTWARD		LAKESHORE - WEEKDAY										
Bus Connections												
CYCLE FROM		502	880	783	910	560	712	504	882	785	MY	
STATIONS		Mile	511	881	802	915	513	717	515	883	804	E279U
GO SUBDIVISION												
OSHAWA NORTH	11.6	11:23				11:38	11:53	12:08	12:23			
WHITBY NORTH	8.9	11:29				11:44	11:59	12:14	12:29			
AJAX NORTH	3.5	11:37				11:52	12:07	12:22	12:37			
PICKERING NORTH	1.0	11:43				11:58	12:13	12:28	12:43			
KINGSTON SUBDIVISION												
PICKERING SOUTH	312.9			
DURHAM JCT	313.9	(11:45)				(12:00)	(12:15)	(12:30)	(12:45)			
ROUGE HILL	317.3	11:50				12:05	12:20	12:35	12:50			
GUILDWOOD	321.2	11:57				12:12	12:27	12:42	12:57			
EGLINTON	323.2	12:02				12:17	12:32	12:47	13:02			
SCARBOROUGH	325.2	12:07	(12:10)			12:22	12:37	12:52	13:07	(13:10)		
DANFORTH	328.6	12:12				12:27	12:42	12:57	13:12			
USRC			From Uxbridge Sub	From Newmarket Sub						From Uxbridge Sub	From Newmarket Sub	From Oakville Sub
SCOTT ST.	333.3	(12:20)				(12:35)	(12:50)	(13:05)	(13:20)			
TORONTO	333.8	12:26	12:27	12:33	12:41	12:56	13:11	13:26	13:41	13:47	13:53	(13:43)
CYCLE TO		514	787	277	E515W	789	E804W	279	
CYCLE FROM		511	881	802	515	883	804	E279U	
TORONTO	0.0	13:33	12:40	12:53	12:43	12:58	13:13	(13:31)	13:40	(13:43)	13:53	
JOHN ST.	0.5	To Kingston Sub	To Newmarket Sub	To Weston Sub	↓	To Newmarket Sub	↓	To Weston Sub	
OAKVILLE SUBDIVISION												
EXHIBITION	2.0				12:50	13:05	13:20	↓				
MIMICO	6.7				12:58	13:13	13:28	(13:51)		(14:03)		
CANPA	8.4								
LONG BRANCH	9.6				13:04	13:19	13:34					
PORT CREDIT	12.8				13:10	13:25	13:40					
CLARKSON	16.7				13:16	13:31	13:46					
OAKVILLE	21.4				13:24	13:39	13:54					
BRONTE	24.7				13:30		14:00					
APPLEBY	27.9				13:37		14:07					
BURLINGTON	31.5				13:44		14:14					
ALDRESHOT	34.6				13:51		14:21					
HAMILTON JCT	37.3											
WEST HARBOUR	39.3											
CP HAMILTON SUBDIVISION												
DESJARDINS	60.1											
MAIN	58.9											
LOCKE	58.4											
PARK	57.6											
HAMILTON	57.5											
GRIMSBY SUB												
LEWIS RD LAYOVER	32.7											
CYCLE TO		514	787	277	915	513	717	E515W	789	E804W	279	
CYCLE FROM		E514H	806	278	920	520	722	WB	808	WB	280	
Bus Connections												



WESTWARD		LAKESHORE - WEEKDAY											
Bus Connections													
CYCLE FROM		912	275	506	714	508	LI			789	510		
STATIONS		917	276	517	719	519	885			808	569		
GO SUBDIVISION													
OSHAWA NORTH	11.6	12:38		12:53	13:08	13:23					13:52		
WHITBY NORTH	8.9	12:44		12:59	13:14	13:29					↓		
AJAX NORTH	3.5	12:52		13:07	13:22	13:37					↓		
PICKERING NORTH	1.0	12:58		13:13	13:28	13:43					↓		
KINGSTON SUBDIVISION													
PICKERING SOUTH	312.9					↓		
DURHAM JCT	313.9	(13:00)		(13:15)	(13:30)	(13:45)					↓		
ROUGE HILL	317.3	13:05		13:20	13:35	13:50					↓		
GUILDWOOD	321.2	13:12		13:27	13:42	13:57					↓		
EGLINTON	323.2	13:17		13:32	13:47	14:02					↓		
SCARBOROUGH	325.2	13:22		13:37	13:52	14:07	(14:10)				↓		
DANFORTH	328.6	13:27		13:42	13:57	14:12					↓		
USRC													
SCOTT ST.	333.3	(13:35)	From Weston Sub	(13:50)	(14:05)	(14:20)	From Uxbridge Sub			From Newmarket Sub	↓		
TORONTO	333.8	13:41		13:54	14:11	14:26	14:27			15:38	14:40		
CYCLE TO		E276Y	E517W	E519D	E885B	MY	MY	E808W	281		
CYCLE FROM		276	517	519	885			808	569		
TORONTO	0.0	13:43	(14:04)	(13:59)	14:13	(14:36)	(14:32)			(15:48)	14:53		
JOHN ST.	0.5	↓	↓	To Don Yard	To BNY (14:42)			↓	To Weston Sub		
USRC													
OAKVILLE SUBDIVISION													
EXHIBITION	2.0	13:50	↓	↓	14:20					↓			
MIMICO	6.7	13:58	(14:29)	(14:19)	14:28					(16:08)			
CANPA	8.4			(14:25)	(14:55)				
LONG BRANCH	9.6	14:04			14:34			↓	↓				
PORT CREDIT	12.8	14:10			14:40								
CLARKSON	16.7	14:16			14:46			↓	↓				
OAKVILLE	21.4	14:24			14:54			(15:00)	(15:30)				
BRONTE	24.7	14:30			15:00								
APPLEBY	27.9	14:37			15:07								
BURLINGTON	31.5	14:44			15:14								
ALDRESHOT	34.6	14:51			15:21								
HAMILTON JCT	37.3												
WEST HARBOUR	39.3												
CP HAMILTON SUBDIVISION													
DESJARDINS	60.1												
MAIN	58.9												
LOCKE	58.4												
PARK	57.6												
HAMILTON	57.5												
HAMILTON LAYOVER													
GRIMSBY SUB													
LEWIS RD LAYOVER		32.7											
		917	E276Y	E517W	719	E519D	E885B	E424	E426	E808W	281		
CYCLE TO		922	MY	WB	724	DY	BNY	424	426	WB	282		
Bus Connections													

















WESTWARD		LAKESHORE - WEEKDAY									
Bus Connections											
CYCLE FROM		787	914		716	DY		512	886	916	514
STATIONS		806	919		721LE	E721		521	887	921	E514H
GO SUBDIVISION											
OSHAWA NORTH	11.6		13:38		14:08			14:22		14:36	(14:37)
WHITBY NORTH	8.9		13:44		14:14			14:28		14:42	(14:52)
AJAX NORTH	3.5		13:52		14:22			14:36		14:50	TO
PICKERING NORTH	1.0		13:58		14:28			14:42		14:55	HENRY
KINGSTON SUBDIVISION											
PICKERING SOUTH	312.9		
DURHAM JCT	313.9		(14:00)		(14:30)			(14:44)		(14:57)	
ROUGE HILL	317.3		14:05		14:35			14:49		15:02	
GUILDWOOD	321.2		14:12		14:42			14:56		15:09	
EGLINTON	323.2		14:17		14:47					15:14	
SCARBOROUGH	325.2		14:22		14:52				(15:10)	15:19	
DANFORTH	328.6		14:27		14:57					15:24	
USRC			From			(14:45)			From		
SCOTT ST.	333.3	Newmarket				From			Uxbridge		
TORONTO	333.8	Sub	(14:35)		(15:05)	Don Yd			Sub		
CYCLE TO		791		793	721LW	E726	471	E887D	
CYCLE FROM		806	WB	721LE	E721	721LW	521	887	
TORONTO	0.0	14:40	14:43		15:40	15:15		15:30	(15:37)	15:40	
JOHN ST.	0.5	To		To	To	
USRC			Newmarket		Newmarket				Kingston		
OAKVILLE SUBDIVISION											
EXHIBITION	2.0		14:50			15:22				15:47	
MIMICO	6.7		14:58			15:30				15:55	
CANPA	8.4		(15:20)						
LONG BRANCH	9.6		15:04			15:36				16:01	
PORT CREDIT	12.8		15:10			15:42				16:07	
CLARKSON	16.7		15:16			15:48		15:53		16:13	
OAKVILLE	21.4		15:24	(15:45)		15:56		16:01		16:21	
BRONTE	24.7		15:30			16:02		16:07		16:27	
APPLEBY	27.9		15:37			16:09		16:14		16:34	
BURLINGTON	31.5		15:44			16:16	(16:18)	16:21		16:41	
ALDRESHOT	34.6		15:51				(16:23)	16:28		16:48	
HAMILTON JCT	37.3										
WEST HARBOUR	39.3										
CP HAMILTON SUBDIVISION											
DESJARDINS	60.1										
MAIN	58.9										
LOCKE	58.4										
PARK	57.6										
HAMILTON	57.5										
GRIMSBY SUB											
LEWIS RD LAYOVER	32.7										
CYCLE TO		791	919	E428	793	721LW	E726	471	E887D	921	
CYCLE FROM		BR	924LW	428	AE	E726	726	E803U	DY	926	
Bus Connections											

WESTWARD		LAKESHORE - WEEKDAY									
Bus Connections											
CYCLE FROM		718		279	516	DON	918	518	858	DY	WRMF
STATIONS		473		280	723	E797	475	923	889	E155	E799
GO SUBDIVISION											
OSHAWA NORTH	11.6	14:50			15:06		15:20	15:36			
WHITBY NORTH	8.9	14:56			15:12		15:26	15:42			(15:46)
AJAX NORTH	3.5	15:04			15:20		15:34	15:50			
PICKERING NORTH	1.0	15:09			15:25		15:39	15:55			
KINGSTON SUBDIVISION											
PICKERING SOUTH	312.9			
DURHAM JCT	313.9	(15:11)			(15:27)		(15:41)	(15:57)			
ROUGE HILL	317.3	15:16			15:32		15:46	16:02			
GUILDWOOD	321.2	15:23			15:39		15:53	16:09			
EGLINTON	323.2	15:28			15:44		15:58	16:14			
SCARBOROUGH	325.2	15:33			15:49		16:03	16:19	(16:10)		
DANFORTH	328.6	15:38			15:54		16:08	16:24			
USRC											
SCOTT ST.	333.3			From Weston Sub		(16:00) From Don Yd			From Uxbridge Sub	(16:20) From Don Yd	
TORONTO	333.8	15:52		15:54	16:08	(16:15)	16:22	16:38	16:27	(16:40)	(16:35)
CYCLE TO		E473G	205	797	207	155	799
CYCLE FROM				280	E797	889	E155	E799
TORONTO	0.0	16:00		16:20	16:10	16:40	16:30	16:40	16:50	16:55	17:05
JOHN ST.	0.5		To Weston Sub	To Newmkt Sub	To Weston Sub	To Galt Sub	To Newmkt Sub
OAKVILLE SUBDIVISION											
EXHIBITION	2.0				16:17			16:47			
MIMICO	6.7				16:25			16:55			
CANPA	8.4										
LONG BRANCH	9.6				16:31			17:01			
PORT CREDIT	12.8				16:37			17:07			
CLARKSON	16.7	16:23			16:43		16:53	17:13			
OAKVILLE	21.4	16:31			16:51		17:01	17:21			
BRONTE	24.7	16:37			16:57		17:07	17:27			
APPLEBY	27.9	16:44			17:04		17:14	17:34			
BURLINGTON	31.5	16:51			17:11		17:21	17:41			
ALDRESHOT	34.6	16:58			17:18		17:28	17:48			
HAMILTON JCT	37.3							(17:32)			
WEST HARBOUR	39.3	17:12	(17:30)								
CP HAMILTON SUBDIVISION											
DESJARDINS	60.1							(17:34)			
MAIN	58.9										
LOCKE	58.4										
PARK	57.6										
HAMILTON	57.5							17:45			
HAMILTON LAYOVER								(17:50)			
GRIMSBY SUB											
LEWIS RD LAYOVER	32.7		(17:50)								
CYCLE TO		473	E473G	205	723	797	475	923	207	155	799
Bus Connections			Lewis Rd	GT		E797A	HA		KW	E155M	AE

WESTWARD		LAKESHORE - WEEKDAY									
Bus Connections											
CYCLE FROM		829	720	DON	DON	DY	DON	DON	WB	E481O	
STATIONS		Mile	E285	477	E157	E479	E481U	E209U	E159	E801	481LE
GO SUBDIVISION											
OSHAWA NORTH	11.6		15:53								16:11
WHITBY NORTH	8.9		15:59								16:17
AJAX NORTH	3.5		16:07								16:25
PICKERING NORTH	1.0		16:12								16:31
KINGSTON SUBDIVISION											
PICKERING SOUTH	312.9	
DURHAM JCT	313.9		(16:14)								(16:33)
ROUGE HILL	317.3		16:19								16:38
GUILDWOOD	321.2		16:26								16:45
EGLINTON	323.2		16:31								16:50
SCARBOROUGH	325.2		16:36								16:55
DANFORTH	328.6		16:41								17:00
USRC			From	(16:40)	(16:45)	(16:55)	(16:50)	(17:00)	From		
SCOTT ST.	333.3		Bala	From	From	From	From	From	From	From	
TORONTO	333.8	(16:52)	Sub	Don Yd	Don Yd	Don Yd	Don Yd	Don Yd	Don Yd	Don Yd	
CYCLE TO		285	157	479	481LW	209	159	801	835	E481G
CYCLE FROM		E285	E157	E479	E481U	E209U	E159	E801	481LE	
TORONTO	0.0	17:02	17:00	17:10	17:10	17:15	17:20	17:25	17:35	17:30	
JOHN ST.	0.5	To	To	To	To	To	To	
USRC			Weston	Galt			Weston	Galt	Newmrkt	Bala	
			Sub	Sub			Sub	Sub	Sub	Sub	
OAKVILLE SUBDIVISION											
EXHIBITION	2.0				17:17						
MIMICO	6.7				17:25						
CANPA	8.4										
LONG BRANCH	9.6				17:31						
PORT CREDIT	12.8				17:37						
CLARKSON	16.7		17:23		17:43						
OAKVILLE	21.4		17:31		17:51						
BRONTE	24.7		17:37		17:57						
APPLEBY	27.9		17:44		18:04						
BURLINGTON	31.5		17:51		18:11						
ALDRESHOT	34.6		17:58		18:18						
HAMILTON JCT	37.3		(18:02)								
WEST HARBOUR	39.3										(18:32)
CP HAMILTON SUBDIVISION											
DESJARDINS	60.1		(18:04)								
MAIN	58.9										
LOCKE	58.4										
PARK	57.6										
HAMILTON	57.5		18:15								
HAMILTON LAYOVER			(18:20)								
GRIMSBY SUB											
LEWIS RD LAYOVER	32.7										(18:52)
CYCLE TO		285	477	157	479	481LW	209	159	801	835	E481G
		E892	HA	E157M	730	E481G	KW	E159M	AE	E835R	Lewis Rd
Bus Connections		 									

WESTWARD		LAKESHORE - WEEKDAY									
Bus Connections											
CYCLE FROM		DON	722	920	WRMF	DON	424	471	922		426
STATIONS		E483	E161	925	E163	E434	485	E803U	727		487
Mile											
GO SUBDIVISION											
OSHAWA NORTH	11.6			16:33			17 01		17 18		17 27
WHITBY NORTH	8.9			16:39	(16:53)		17 07		17 24		17 33
AJAX NORTH	3.5			16:47			17 15		17 31		17 40
PICKERING NORTH	1.0			16:52			17 20		17 36		17 45
KINGSTON SUBDIVISION											
PICKERING SOUTH	312.9		(16:31)
DURHAM JCT	313.9			(16:54)			(17:22)		(17:38)		(17:47)
ROUGE HILL	317.3			16:59					17 43		17 51
GUILDWOOD	321.2			17:06							17 58
EGLINTON	323.2			17:11							18 03
SCARBOROUGH	325.2			17:16							18 08
DANFORTH	328.6			17:21			17:41		17:56		
USRC		(17:05)				(17:30)		From			
SCOTT ST.	333.3	From				From		Oakville			
TORONTO	333.8	Don Yd	(17:05)			Don Yd		Sub			
CYCLE TO		161	163	434	803	727
CYCLE FROM		E161	E163	E434	E803U	727
TORONTO	0.0	17:30	17:40	17:40	17:55	(18:00)	18:00	18:05	18:15		18:30
JOHN ST.	0.5	To		To	To	To		
USRC			Galt		Galt	Kingston		Newmrkt			
			Sub		Sub	Sub		Sub			
OAKVILLE SUBDIVISION											
EXHIBITION	2.0			17:47					18:22		
MIMICO	6.7			17:55					18:30		
CANPA	8.4										
LONG BRANCH	9.6			18:01					18:36		
PORT CREDIT	12.8			18:07					18:42		
CLARKSON	16.7	17:53		18:13			18:23		18:48		18:53
OAKVILLE	21.4	18:01		18:21			18:31		18:56		19:01
BRONTE	24.7	18:07		18:27			18:37		19:02		19:07
APPLEBY	27.9	18:14		18:34			18:44		19:09		19:14
BURLINGTON	31.5	18:21		18:41			18:51		19:16	(19:18)	19:21
ALDRESHOT	34.6	18:28		18:48			18:58			(19:23)	19:28
HAMILTON JCT	37.3	(18:32)					(19:02)				
WEST HARBOUR	39.3										
CP HAMILTON SUBDIVISION											
DESJARDINS	60.1	(18:34)					(19:04)				
MAIN	58.9										
LOCKE	58.4										
PARK	57.6										
HAMILTON	57.5	18:45					19:15				
HAMILTON LAYOVER		(18:50)					(19:20)				
GRIMSBY SUB											
LEWIS RD LAYOVER	32.7										
CYCLE TO		483	161	925	163	434	485	803	727	E732	487
CYCLE FROM		HA	E161M	930	E163M	731	HA	AE	E732	732	E811
Bus Connections											



WESTWARD		LAKESHORE - WEEKDAY									
Bus Connections											
CYCLE FROM		724	428	430	432	924LE	726	E124	DY	434	926
STATIONS		927	E428X	729	E432X	929	563	E125W	E890U	731	931
GO SUBDIVISION											
OSHAWA NORTH	11.6	17:41	(18:01)		(18:31)	18:38	19:00			19:08	19:38
WHITBY NORTH	8.9	17:47	(18:26)		(18:56)	18:44	↓			19:14	19:44
AJAX NORTH	3.5	17:55	TO		TO	18:52				19:22	19:52
PICKERING NORTH	1.0	18:01	WRMF		WRMF	18:58				19:28	19:58
KINGSTON SUBDIVISION											
PICKERING SOUTH	312.9		18:25	
DURHAM JCT	313.9	(18:05)		(18:27)							
ROUGE HILL	317.3	18:08		18:32		19:05				19:35	20:05
GUILDWOOD	321.2	18:15		18:38		19:12				19:42	20:12
EGLINTON	323.2	18:20		18:43		19:17				19:47	20:17
SCARBOROUGH	325.2	18:25		18:47		19:22				19:52	20:22
DANFORTH	328.6	18:30		18:52		19:27				19:57	20:27
USRC											
SCOTT ST.	333.3	(18:38)		(18:59)		(19:35)	↓	(18:55)	(19:35) From Don Yd	(20:05)	(20:35)
TORONTO	333.8	18:41		19:05		19:41	19:45		(19:55)	20:11	20:41
CYCLE TO		E813B		890
CYCLE FROM											
TORONTO	0.0	18:43		19:13		19:43	563 (19:45)		E890U 20:00	20:13	20:43
JOHN ST.	0.5	To Bathurst Yard (19:50)	↓	To Uxbridge Sub
USRC											
OAKVILLE SUBDIVISION											
EXHIBITION	2.0	18:50		19:20		19:50	Temporary Storage Before Revenue			20:20	20:50
MIMICO	6.7	18:58		19:28		19:58		(01:03)		20:28	20:58
CANPA	8.4
LONG BRANCH	9.6	19:04		19:34		20:04				20:34	21:04
PORT CREDIT	12.8	19:10		19:40		20:10			20:40	21:10	
CLARKSON	16.7	19:16		19:46		20:16			20:46	21:16	
OAKVILLE	21.4	19:24		19:54		20:24			20:54	21:24	
BRONTE	24.7	19:30		20:00		20:30			21:00	21:30	
APPLEBY	27.9	19:37		20:07		20:37			21:07	21:37	
BURLINGTON	31.5	19:44		20:14		20:44			21:14	21:44	
ALDRESHOT	34.6	19:51		20:21		20:51			21:21	21:51	
HAMILTON JCT	37.3										
WEST HARBOUR	39.3										
CP HAMILTON SUBDIVISION											
DESJARDINS	60.1										
MAIN	58.9										
LOCKE	58.4										
PARK	57.6										
HAMILTON	57.5										
HAMILTON LAYOVER											
GRIMSBY SUB											
LEWIS RD LAYOVER		32.7									
		927		729		929	E813B	E125W	890	731	931
CYCLE TO		932		734		934	E813U	WB	891	736	936
Bus Connections											

WESTWARD		LAKESHORE - WEEKDAY									
Bus Connections											
CYCLE FROM		728	841	928	730	809	811	930	892	732	813
STATIONS	Mile	733	E894U	933	735	810	812	935	893	737	814
GO SUBDIVISION											
OSHAWA NORTH	11.6	20:08		20:38	21:08			21:38		22:08	
WHITBY NORTH	8.9	20:14		20:44	21:14			21:44		22:14	
AJAX NORTH	3.5	20:22		20:52	21:22			21:52		22:22	
PICKERING NORTH	1.0	20:28		20:58	21:28			21:58		22:28	
KINGSTON SUBDIVISION											
PICKERING SOUTH	312.9	
DURHAM JCT	313.9							(22:00)		(22:30)	
ROUGE HILL	317.3	20:35		21:05	21:35			22:05		22:35	
GUILDWOOD	321.2	20:42		21:12	21:42			22:12		22:42	
EGLINTON	323.2	20:47		21:17	21:47			22:17		22:47	
SCARBOROUGH	325.2	20:52		21:22	21:52			22:22	(22:35)	22:52	
DANFORTH	328.6	20:57		21:27	21:57			22:27		22:57	
USRC											
SCOTT ST.	333.3	(21:05)	From Bala Sub	(21:35)	(22:05)	From Newmkt Sub	From Newmkt Sub	(22:35)	From Uxbridge Sub	(23:05)	From Newmkt Sub
TORONTO	333.8	21:11	(21:30)	21:41	22:11	21:33	22:33	22:41	22:52	23:11	23:33
CYCLE TO		894	815	E812W	E893W	E814W
USRC											
CYCLE FROM		E894U	810	812	893	814
TORONTO	0.0	21:13	21:40	21:43	22:13	22:40	(22:38)	22:43	(22:57)	23:13	(23:35)
JOHN ST.	0.5	To Uxbridge Sub	To Newmkt Sub	Change ends at Scott St.	↓	Change ends at Scott St.
OAKVILLE SUBDIVISION											
EXHIBITION	2.0	21:20		21:50	22:20		↓	22:50	↓	23:20	↓
MIMICO	6.7	21:28		21:58	22:28		(23:08)	22:58	(23:17)	23:28	(00:03)
CANPA	8.4	
LONG BRANCH	9.6	21:34		22:04	22:34			23:04		23:34	
PORT CREDIT	12.8	21:40		22:10	22:40			23:10		23:40	
CLARKSON	16.7	21:46		22:16	22:46			23:16		23:46	
OAKVILLE	21.4	21:54		22:24	22:54			23:24		23:54	
BRONTE	24.7	22:00		22:30	23:00			23:30		00:00	
APPLEBY	27.9	22:07		22:37	23:07			23:37		00:07	
BURLINGTON	31.5	22:14		22:44	23:14			23:44		00:14	
ALDRESHOT	34.6	22:21		22:51	23:21			23:51		00:21	
HAMILTON JCT	37.3										
WEST HARBOUR	39.3										
CP HAMILTON SUBDIVISION											
DESJARDINS	60.1										
MAIN	58.9										
LOCKE	58.4										
PARK	57.6										
HAMILTON	57.5										
HAMILTON LAYOVER											
GRIMSBY SUB											
LEWIS RD LAYOVER	32.7										
CYCLE TO		733	894	933	735	815	E812W	935	E893W	737	E814W
Bus Connections											

WESTWARD		LAKESHORE - WEEKDAY									
Bus Connections											
CYCLE FROM		932	894	734	934	736	936	738	938	740	4149
STATIONS		937	895	739	939	E736X	E936X	E738X	E938X	E740X	4156
GO SUBDIVISION											
OSHAWA NORTH	11.6	22:38		23:08	23:38	(23:51)	(00:21)	(00:51)	(01:21)	(01:51)	
WHITBY NORTH	8.9	22:44		23:14	23:44	(00:16)	(00:46)	(01:16)	(01:46)	(02:16)	
AJAX NORTH	3.5	22:52		23:22	23:52	TO	TO	TO	TO	TO	
PICKERING NORTH	1.0	22:58		23:28	23:58	WRMF	WRMF	WRMF	WRMF	WRMF	
KINGSTON SUBDIVISION											
PICKERING SOUTH	312.9						
DURHAM JCT	313.9	(23:00)		(23:30)	(00:00)						
ROUGE HILL	317.3	23:05		23:35	00:05						
GUILDWOOD	321.2	23:12		23:42	00:12						
EGLINTON	323.2	23:17		23:47	00:17						
SCARBOROUGH	325.2	23:22	(23:25)	23:52	00:22						
DANFORTH	328.6	23:27		23:57	00:27						
USRC											
SCOTT ST.	333.3	(23:35)	Uxbridge Sub	(00:05)	(00:35)						From Weston Sub
TORONTO	333.8	23:41	23:42	00:11	00:41						(01:07)
CYCLE TO		E895W						E4156T
CYCLE FROM											
TORONTO	0.0	23:43	(23:47)	00:13	00:43						(01:17)
JOHN ST.	0.5						
USRC											
OAKVILLE SUBDIVISION											
EXHIBITION	2.0	23:50	↓	00:20	00:50						↓
MIMICO	6.7	23:58	(00:12)	00:28	00:58						(01:37)
CANPA	8.4						
LONG BRANCH	9.6	00:04	To	00:34	01:04						
PORT CREDIT	12.8	00:10	WB	00:40	01:10						
CLARKSON	16.7	00:16	C-Yard	00:46	01:16						
OAKVILLE	21.4	00:24		00:54	01:24						
BRONTE	24.7	00:30		01:00	01:30						
APPLEBY	27.9	00:37		01:07	01:37						
BURLINGTON	31.5	00:44		01:14	01:44						
ALDRESHOT	34.6	00:51		01:21	01:51						
HAMILTON JCT	37.3										
WEST HARBOUR	39.3										
CP HAMILTON SUBDIVISION											
DESJARDINS	60.1										
MAIN	58.9										
LOCKE	58.4										
PARK	57.6										
HAMILTON	57.5										
HAMILTON LAYOVER											
GRIMSBY SUB											
LEWIS RD LAYOVER	32.7										
		937	E895W	739	939						E4156T
CYCLE TO		E937W	WB	E739W	E939W						TMC
Bus Connections											



WESTWARD		LAKESHORE - WEEKDAY			
Bus Connections					
CYCLE FROM		4151	4153	4155	4157
STATIONS	Mile	4158	E4153U	E4155U	E4157U
GO SUBDIVISION					
OSHAWA NORTH	11.6				
WHITBY NORTH	8.9				
AJAX NORTH	3.5				
PICKERING NORTH	1.0				
KINGSTON SUBDIVISION					
PICKERING SOUTH	312.9				
DURHAM JCT	313.9				
ROUGE HILL	317.3				
GUILDWOOD	321.2				
EGLINTON	323.2				
SCARBOROUGH	325.2				
DANFORTH	328.6				
USRC		From Weston Sub	From Weston Sub	From Weston Sub	From Weston Sub
SCOTT ST.	333.3				
TORONTO	333.8	(01:22)	01:28	(01:43)	01:58
CYCLE TO		E4158W	E4153W	E4155W	E4157W
CYCLE FROM		4158	E4153U	E4155U	E4157U
TORONTO	0.0	(01:32)	(01:38)	(01:53)	(02:08)
JOHN ST.	0.5				
USRC					
OAKVILLE SUBDIVISION					
EXHIBITION	2.0	↓	↓	↓	↓
MIMICO	6.7	(01:52)	(02:03)	(02:13)	(02:33)
CANPA	8.4				
LONG BRANCH	9.6				
PORT CREDIT	12.8				
CLARKSON	16.7				
OAKVILLE	21.4				
BRONTE	24.7				
APPLEBY	27.9				
BURLINGTON	31.5				
ALDERSHOT	34.6				
HAMILTON JCT	37.3				
WEST HARBOUR	39.3				
CP HAMILTON SUBDIVISION					
DESJARDINS	60.1				
MAIN	58.9				
LOCKE	58.4				
PARK	57.6				
HAMILTON	57.5				
HAMILTON LAYOVER					
GRIMSBY SUB					
LEWIS RD LAYOVER	32.7				
CYCLE TO		WB	WB	WB	WB
Bus Connections					









EASTWARD		LAKESHORE - WEEKDAY									
Bus Connections											
CYCLE TO				260	PE	250	PE	PE	PE	PE	
STATIONS	Mile			E260	4201	E250	4203	4001	E4006	4003	
OSHAWA NORTH	11.6										
WHITBY NORTH	8.9										
AJAX NORTH	3.5										
PICKERING NORTH	1.0										
GO SUBDIVISION											
PICKERING SOUTH	312.9										
DURHAM JCT	313.9										
ROUGE HILL	317.3										
GUILDWOOD	321.2										
EGLINTON	323.2										
SCARBOROUGH	325.2										
DANFORTH	328.6										
KINGSTON SUBDIVISION											
USRC				To Weston Sub	To Weston Sub	To Weston Sub	To Weston Sub	To Weston Sub	To Weston Sub	To Weston Sub	
SCOTT ST.	333.3										
TORONTO	333.8			(04:45)	04:55	(04:55)	05:10	(05:30)	(05:26)	(05:45)	
CYCLE FROM				E260U	E4201	E250U	E4203	E4001	E4006U	E4003	
CYCLE TO				E260	4201	E250	4203	4001	E4006	4003	
TORONTO	0.0			(04:35)	(04:46)	(04:45)	(05:01)	(05:10)	(05:16)	(05:35)	
JOHN ST.	0.5			↑	↑	↑	↑	↑	↑	↑	
USRC											
EXHIBITION	2.0			↑	↑	↑	↑	↑	↑	↑	
MIMICO	6.7			(04:15)	(04:21)	(04:25)	(04:41)	(04:50)	(04:51)	(05:15)	
CANPA	8.4	(01:06)	(01:36)	(02:36)							
LONG BRANCH	9.6	↑	↑	↑							
PORT CREDIT	12.8										
CLARKSON	16.7										
OAKVILLE	21.4										
BRONTE	24.7										
APPLEBY	27.9										
BURLINGTON	31.5										
ALDRESHOT	34.6	(00:31)	(01:01)	(02:01)							
HAMILTON JCT	37.3										
WEST HARBOUR	39.3										
OAKVILLE SUBDIVISION											
DESJARDINS	60.1										
MAIN	58.9										
LOCKE	58.4										
PARK	57.6										
HAMILTON	57.5										
HAMILTON LAYOVER											
CP HAMILTON SUBDIVISION											
LEWIS RD LAYOVER	32.7										
GRIMSBY SUB											
		E737W	E937W	E939W	E260U	E4201	E250U	E4203	E4001	E4006U	E4003
CYCLE FROM		737	937	939	WB	WB	WB	TMC	WB	WB	WB
Bus Connections											







EASTWARD		LAKESHORE - WEEKDAY									
Bus Connections											
CYCLE TO		705	905	421	705	423	905	425	707	429	907
STATIONS	Mile	E703	E903	E421	E705	E423	E905	E425	E707	700	550
OSHAWA NORTH	11.6	(04:57)	(05:27)	(05:52)	(06:02)	(06:22)	(06:32)	(06:52)	(07:00)	07:11	07:25
WHITBY NORTH	8.9	(04:32)	(05:02)	(05:27)	(05:37)	(05:57)	(06:07)	(06:27)	↑	07:04	↑
AJAX NORTH	3.5	From	From	From	From	From	From	From		06:56	
PICKERING NORTH	1.0	WRMF	WRMF	WRMF	WRMF	WRMF	WRMF	WRMF		06:51	
GO SUBDIVISION											
PICKERING SOUTH	312.9									
DURHAM JCT	313.9									(06:49)	
ROUGE HILL	317.3									06:43	
GUILDWOOD	321.2									06:38	
EGLINTON	323.2									06:33	
SCARBOROUGH	325.2									06:29	
DANFORTH	328.6									06:23	
KINGSTON SUBDIVISION											
USRC											
SCOTT ST.	333.3									
TORONTO	333.8									06:13	06:38
CYCLE FROM										250
CYCLE TO										550
TORONTO	0.0									06:10	06:32
JOHN ST.	0.5									(06:06)	From Weston Sub
USRC											
EXHIBITION	2.0									05:59	
MIMICO	6.7								(05:45)	05:53	
CANPA	8.4									
LONG BRANCH	9.6									05:47	
PORT CREDIT	12.8									05:42	
CLARKSON	16.7									05:35	
OAKVILLE	21.4									05:27	
BRONTE	24.7									05:21	
APPLEBY	27.9									05:16	
BURLINGTON	31.5									05:09	
ALDRESHOT	34.6									05:03	
HAMILTON JCT	37.3										
WEST HARBOUR	39.3										
OAKVILLE SUBDIVISION											
DESJARDINS	60.1										
MAIN	58.9										
LOCKE	58.4										
PARK	57.6										
HAMILTON	57.5										
HAMILTON LAYOVER											
CP HAMILTON SUBDIVISION											
LEWIS RD LAYOVER	32.7										
GRIMSBY SUB											
CYCLE FROM									E707 WB	700 E700	250 E250
Bus Connections											

EASTWARD		LAKESHORE - WEEKDAY									
Bus Connections											
CYCLE TO		431	427	DON	DON	709	909	Cherry St	DON		DON
STATIONS		Mile	900	552	E490D	E148D	554	702	E830C	E152D	E470D
OSHAWA NORTH	11.6	07:41				07:55	08:16				
WHITBY NORTH	8.9	07:34				↑	08:09				
AJAX NORTH	3.5	07:26				↑	08:01				
PICKERING NORTH	1.0	07:21				↑	07:56				
GO SUBDIVISION											
PICKERING SOUTH	312.9	07:25							
DURHAM JCT	313.9	(07:19)	↑				(07:55)				
ROUGE HILL	317.3	07:13					07:48				
GUILDWOOD	321.2	07:08					07:43				
EGLINTON	323.2	07:03					07:38				
SCARBOROUGH	325.2	06:59					07:34				
DANFORTH	328.6	06:53					07:28				
KINGSTON SUBDIVISION											
USRC				Don Yd	Don Yd			To	Don Yd		Don Yd
SCOTT ST.	333.3		(07:20)	(07:21)		Cherry St	(08:05)		(07:40)
TORONTO	333.8	06:43	06:55	(07:05)	(07:06)	07:13	07:18	(07:21)	(07:50)		(07:25)
CYCLE FROM		...	260	490	148	782	830	152	E470	470
CYCLE TO		...	552	E490D	E148D	554	E830C	E152D		E470D
TORONTO	0.0	06:40	06:50	07:00	07:00	07:03	07:15	07:11	07:45		07:20
JOHN ST.	0.5	(06:36)	From	(06:56)	From	From	(07:14)	From	From		(07:16)
USRC			Weston	↑	Galt	Newmkt		Bala	Galt		↑
EXHIBITION	2.0	06:29	Sub		Sub	Sub		Sub	Sub		
MIMICO	6.7	06:23					07:08				
CANPA	8.4					07:01				
LONG BRANCH	9.6	06:17					06:55				
PORT CREDIT	12.8	06:12					06:50				
CLARKSON	16.7	06:05		06:35			06:43				06:55
OAKVILLE	21.4	05:57		06:27			06:35				06:47
BRONTE	24.7	05:51		06:21			06:29				06:41
APPLEBY	27.9	05:46		06:16			06:24				06:36
BURLINGTON	31.5	05:39		06:09			06:17				06:29
ALDRESHOT	34.6	05:33		06:03							06:23
HAMILTON JCT	37.3			(05:56)							↑
WEST HARBOUR	39.3			↑					(05:59)		06:09
OAKVILLE SUBDIVISION											
DESJARDINS	60.1			(05:54)							
MAIN	58.9			↑							
LOCKE	58.4			↑							
PARK	57.6			↑							
HAMILTON	57.5			05:48							
HAMILTON LAYOVER				(05:38)							
CP HAMILTON SUBDIVISION											
LEWIS RD LAYOVER	32.7								(05:39)		
GRIMSBY SUB											
		900	260	490	148	782	702	830	152	E470	470
CYCLE FROM		E900	E260	HA	MI	AE	E702	RI	MI	Lewis Rd	E470
Bus Connections											





EASTWARD		LAKESHORE - WEEKDAY									
Bus Connections											
CYCLE TO		WB	MY	433	503		711	WB	DY	DY	911
STATIONS	Mile	E492W	E208Y	556	902		704	E494W	E154D	E156D	904
OSHAWA NORTH	11.6			08:30	08:46		09:01				09:16
WHITBY NORTH	8.9			↑	08:39		08:54				09:09
AJAX NORTH	3.5				08:31		08:46				09:01
PICKERING NORTH	1.0				08:26		08:41				08:56
GO SUBDIVISION											
PICKERING SOUTH	312.9			
DURHAM JCT	313.9				(08:25)		(08:40)				(08:55)
ROUGE HILL	317.3				08:18		08:33				08:48
GUILDWOOD	321.2				08:13		08:28				08:43
EGLINTON	323.2				08:08		08:23				08:38
SCARBOROUGH	325.2				08:04		08:19	Change ends at Scott St.			08:34
DANFORTH	328.6				07:58		08:13				08:28
KINGSTON SUBDIVISION											
USRC		To Oakville Sub	To Oakville Sub					To Oakville Sub	Don Yd (08:22)	Don Yd (08:35)	
SCOTT ST.	333.3			
TORONTO	333.8	(07:35)	(08:06)	07:40	07:48		08:03	(08:05)	(08:07)	(08:20)	08:18
CYCLE FROM		492	208	784	E704	494	154	156
CYCLE TO		E492W	E208Y	556	E494W	E154D	E156D
TORONTO	0.0	07:30	07:55	07:33	07:45		07:50	08:00	08:02	08:15	08:15
JOHN ST.	0.5	(07:26)	From Weston Sub	From Newmkt Sub	(07:44)		(07:46)	(07:56)	From Galt Sub	From Galt Sub	(08:14)
USRC		↑					↑	↑			
EXHIBITION	2.0				07:38						08:08
MIMICO	6.7				07:31						08:01
CANPA	8.4			
LONG BRANCH	9.6				07:25						07:55
PORT CREDIT	12.8				07:20						07:50
CLARKSON	16.7	07:05			07:13		07:25	07:35			07:43
OAKVILLE	21.4	06:57			07:05		07:17	07:27			07:35
BRONTE	24.7	06:51			06:59		07:11	07:21			
APPLEBY	27.9	06:46			06:54		07:06	07:16			
BURLINGTON	31.5	06:39			06:47		06:59	07:09			
ALDRESHOT	34.6	06:33					06:53	07:03			
HAMILTON JCT	37.3	(06:26)					↑	(06:56)			
WEST HARBOUR	39.3					(06:29)	06:39				
OAKVILLE SUBDIVISION		↑						↑			
DESJARDINS	60.1	(06:24)						(06:54)			
MAIN	58.9	↑						↑			
LOCKE	58.4							↑			
PARK	57.6							↑			
HAMILTON	57.5	06:18						06:48			
HAMILTON LAYOVER		(06:08)						(06:38)			
CP HAMILTON SUBDIVISION											
LEWIS RD LAYOVER	32.7					(06:09)					
GRIMSBY SUB											
		492	208	784	902	E704	704	494	154	156	904
CYCLE FROM		HA	KW	AE	E902	Lewis Rd	E704	HA	E154	E156	551
Bus Connections											





















EASTWARD		LAKESHORE - WEEKDAY																	
Bus Connections																			
CYCLE TO		WRMF	DON	713	DY	DY	BNY	505	WRMF	507	WB								
STATIONS		E790X	E210D	706	E158D	E496D	E836B	906	E160X	708	E472W								
OSHAWA NORTH	11.6	↑ (09:09)		09:31				09:46	↑ (09:28)	10:01									
WHITBY NORTH	8.9			09:24				09:39		09:54									
AJAX NORTH	3.5			09:16				09:31		09:46									
PICKERING NORTH	1.0			09:11				09:26		09:41									
GO SUBDIVISION																			
PICKERING SOUTH	312.9	↑		↑									
DURHAM JCT	313.9			(09:10)				(09:25)		(09:40)									
ROUGE HILL	317.3			09:03				09:18		09:33									
GUILDWOOD	321.2			08:58				09:13		09:28									
EGLINTON	323.2			08:53				09:08		09:23									
SCARBOROUGH	325.2			08:49				09:04		09:19									
DANFORTH	328.6			08:43				08:58		09:13									
KINGSTON SUBDIVISION																			
USRC								Don Yd (08:40)				Don Yd (08:47)	Don Yd (08:50)	To Oakville Sub			To Oakville Sub		
SCOTT ST.	333.3										
TORONTO	333.8	(08:24)	(08:25)	08:33	(08:32)	(08:35)	(08:48)	08:48	(08:43)	09:03	(09:05)								
CYCLE FROM		790	210	158	496	836	160	472								
CYCLE TO		E790X	E210D	E158D	E496D	E836B	E160X	E472W								
TORONTO	0.0	08:19	08:20	08:20	08:27	08:30	08:43	08:45	08:38	08:50	09:00								
JOHN ST.	0.5	From Newmarket Sub	From Weston Sub	(08:16)	From Galt Sub	(08:26)	From Bala Sub	(08:44)	From Galt Sub	(08:46)	(08:56)								
USRC																			
EXHIBITION	2.0	↑						08:38	↑										
MIMICO	6.7							08:31											
CANPA	8.4																	
LONG BRANCH	9.6							08:25											
PORT CREDIT	12.8							08:20											
CLARKSON	16.7							07:55				08:05	08:13	08:25	08:35				
OAKVILLE	21.4							07:47				07:57	08:05	08:17	08:27				
BRONTE	24.7							07:41				07:51		08:11	08:21				
APPLEBY	27.9							07:36				07:46		08:06	08:16				
BURLINGTON	31.5							07:29				07:39		07:59	08:09				
ALDRESHOT	34.6	07:23	07:33		07:53	08:03													
HAMILTON JCT	37.3	↑						(07:26)	↑										
WEST HARBOUR	39.3																		
OAKVILLE SUBDIVISION																			
DESJARDINS	60.1													(07:24)					
MAIN	58.9																		
LOCKE	58.4																		
PARK	57.6																		
HAMILTON	57.5													07:18					
HAMILTON LAYOVER														(07:08)					
CP HAMILTON SUBDIVISION																			
LEWIS RD LAYOVER	32.7																		
GRIMSBY SUB																			
CYCLE FROM		790	210	706	158	496	836	906	160	708	472								
CYCLE TO		AE	GE	703	E158	HA	RH	555	E160	E708	903								
Bus Connections																			







EASTWARD		LAKESHORE - WEEKDAY									
Bus Connections											
CYCLE TO		913	509	MY	272	715	511	881	915	513	717
STATIONS	Mile	908	500	E474Y	271	710	502	880	910	560	712
OSHAWA NORTH	11.6	10:15	10:31			10:46	11:01		11:16	11:32	11:44
WHITBY NORTH	8.9	10:08	10:24			10:39	10:54		11:09	11:22	11:34
AJAX NORTH	3.5	10:00	10:16			10:31	10:46		11:01	11:14	11:26
PICKERING NORTH	1.0	09:55	10:11			10:26	10:41		10:56	11:09	11:21
GO SUBDIVISION											
PICKERING SOUTH	312.9
DURHAM JCT	313.9	(09:54)	(10:10)			(10:25)	(10:40)		(10:50)	(11:04)	(11:20)
ROUGE HILL	317.3	09:47	10:03			10:18	10:33		10:48	11:01	11:13
GUILDWOOD	321.2	09:42	09:58			10:13	10:28		10:43	10:56	11:08
EGLINTON	323.2	09:37	09:53			10:08	10:23		10:38	10:51	11:03
SCARBOROUGH	325.2	09:33	09:49	Change ends at Scott St.		10:04	10:19	(10:28)	10:34	10:47	10:59
DANFORTH	328.6	09:27	09:43			09:58	10:13			10:28	10:41
KINGSTON SUBDIVISION											
USRC											
SCOTT ST.	333.3	To Oakville Sub	To Weston Sub	To Uxbridge Sub
TORONTO	333.8	09:17	09:33	(09:33)	09:48	09:48	10:03	10:15	10:18	10:31	10:43
CYCLE FROM		794	474	796	166	268	E560
CYCLE TO		500	E474Y	271	502	880	560
TORONTO	0.0	09:15	09:03	09:28	09:33	09:46	09:30	09:53	10:16	(10:26)	10:41
JOHN ST.	0.5	(09:11)	From Nwmkt Sub	(09:24)	From Newmarket Sub	(09:42)	From Galt Sub	From Weston Sub	(10:12)	↑	(10:37)
USRC											
EXHIBITION	2.0	09:04		09:17		09:35			10:05		10:30
MIMICO	6.7	08:58		09:11		09:29			09:59	(10:06)	10:24
CANPA	8.4
LONG BRANCH	9.6	08:52		09:03		09:21			09:51		10:16
PORT CREDIT	12.8	08:47		08:58		09:16			09:46		10:11
CLARKSON	16.7	08:40		08:51		09:09			09:39		10:04
OAKVILLE	21.4	08:32		08:43		09:01			09:31		09:56
BRONTE	24.7			08:37		08:55			09:25		09:50
APPLEBY	27.9			08:31		08:49			09:19		09:44
BURLINGTON	31.5					08:42			09:12		09:37
ALDRESHOT	34.6					08:36			09:06		09:31
HAMILTON JCT	37.3										
WEST HARBOUR	39.3										
OAKVILLE SUBDIVISION											
DESJARDINS	60.1										
MAIN	58.9										
LOCKE	58.4										
PARK	57.6										
HAMILTON	57.5										
HAMILTON LAYOVER											
CP HAMILTON SUBDIVISION											
LEWIS RD LAYOVER	32.7										
GRIMSBY SUB											
		908	794	474	796	710	166	268	910	E560	712
CYCLE FROM		E908	BA	553	BR	705	MI	E268	905	WB	707
Bus Connections											







EASTWARD		LAKESHORE - WEEKDAY									
Bus Connections											
CYCLE TO		274	515	883	917	517	276	719	519	885	919
STATIONS		273	504	882	912	506	275	714	508	884	914
OSHAWA NORTH	11.6		12:01		12:16	12:31		12:46	13:02		13:14
WHITBY NORTH	8.9		11:51		12:09	12:24		12:39	12:52		13:04
AJAX NORTH	3.5		11:43		12:01	12:16		12:31	12:44		12:56
PICKERING NORTH	1.0		11:38		11:56	12:11		12:26	12:39		12:51
GO SUBDIVISION											
PICKERING SOUTH	312.9	
DURHAM JCT	313.9		(11:37)		(11:55)	(12:10)		(12:25)	(12:38)		(12:50)
ROUGE HILL	317.3		11:30		11:48	12:03		12:18	12:31		12:43
GUILDWOOD	321.2		11:25		11:43	11:58		12:13	12:26		12:38
EGLINTON	323.2		11:20		11:38	11:53		12:08	12:21		12:33
SCARBOROUGH	325.2		11:16	(11:28)	11:34	11:49		12:04	12:17	(12:28)	12:29
DANFORTH	328.6		11:10		11:28	11:43		11:58	12:11		12:23
KINGSTON SUBDIVISION											
USRC		To		To			To			To	
SCOTT ST.		Weston Sub	Uxbridge Sub	Weston Sub	Uxbridge Sub
TORONTO	333.3	
TORONTO	333.8	10:53	11:00	11:15	11:18	11:33	11:53	11:48	12:01	12:15	12:13
CYCLE FROM		798	270	503	800	272
CYCLE TO		273	882	506	275	884
TORONTO	0.0	10:33	10:58	10:49	11:16	10:26	11:33	11:46	11:59	12:00	12:11
JOHN ST.	0.5	From	(10:54)	From	(11:12)	From	From	(11:42)	(11:55)	From	(12:07)
USRC		Newmarket Sub		Weston Sub		Kingston Sub	Newmarket Sub			Weston Sub	
EXHIBITION	2.0		10:47		11:05			11:35	11:48		12:00
MIMICO	6.7		10:41		10:59			11:29	11:42		11:54
CANPA	8.4	
LONG BRANCH	9.6		10:33		10:51			11:21	11:34		11:46
PORT CREDIT	12.8		10:28		10:46			11:16	11:29		11:41
CLARKSON	16.7		10:21		10:39			11:09	11:22		11:34
OAKVILLE	21.4		10:13		10:31			11:01	11:14		11:26
BRONTE	24.7				10:25			10:55			11:20
APPLEBY	27.9				10:19			10:49			11:14
BURLINGTON	31.5				10:12			10:42			11:07
ALDRESHOT	34.6				10:06			10:36			11:01
HAMILTON JCT	37.3										
WEST HARBOUR	39.3										
OAKVILLE SUBDIVISION											
DESJARDINS	60.1										
MAIN	58.9										
LOCKE	58.4										
PARK	57.6										
HAMILTON	57.5										
HAMILTON LAYOVER											
CP HAMILTON SUBDIVISION											
LEWIS RD LAYOVER	32.7										
GRIMSBY SUB											
		798	504	270	912	503	800	714	508	272	914
CYCLE FROM		BR	499	269	907	704	781	709	501	271	909
Bus Connections											



EASTWARD		LAKESHORE - WEEKDAY									
Bus Connections											
CYCLE TO		569	278	721LE	521	887	921	E514H	WB	473	280
STATIONS	Mile	510	277	716	512	886	916	514	E804W	718	279
OSHAWA NORTH	11.6	13:29		13:44	13:59		14:14	14:29		14:44	
WHITBY NORTH	8.9	13:19		13:34	13:49		14:04	14:19		14:34	
AJAX NORTH	3.5	13:11		13:26	13:41		13:56	14:11		14:26	
PICKERING NORTH	1.0	13:06		13:21	13:36		13:51	14:06		14:21	
GO SUBDIVISION											
PICKERING SOUTH	312.9	
DURHAM JCT	313.9	(13:05)		(13:20)	(13:35)		(13:50)	(14:05)		(14:20)	
ROUGE HILL	317.3	12:58		13:13	13:28		13:43	13:58		14:13	
GUILDWOOD	321.2	12:53		13:08	13:23		13:38	13:53		14:08	
EGLINTON	323.2	12:48		13:03	13:18		13:33	13:48		14:03	
SCARBOROUGH	325.2	12:44		12:59	13:14	(13:28)	13:29	13:44		13:59	
DANFORTH	328.6	12:38		12:53	13:08		13:23	13:38		13:53	
KINGSTON SUBDIVISION											
USRC			To Weston Sub			To Uxbridge Sub			To Oakville Sub		To Weston Sub
SCOTT ST.	333.3			
TORONTO	333.8	12:28	12:53	12:43	12:58	13:15	13:13	13:28	(13:43)	13:43	13:53
CYCLE FROM		507	802	274	511	804	E279U
CYCLE TO		510	277	886	514	E804W	279
TORONTO	0.0	11:26	12:33	12:41	12:56	12:54	13:11	12:26	13:33	13:41	(13:43)
JOHN ST.	0.5	From Kingston Sub	From Newmarket Sub	(12:37)	(12:52)	From Weston Sub	(13:07)	From Kingston Sub	From Newmarket Sub	(13:37)	↑ (13:13)
USRC											
EXHIBITION	2.0			12:30	12:45		13:00			13:30	
MIMICO	6.7			12:24	12:39		12:54			13:24	
CANPA	8.4			
LONG BRANCH	9.6			12:16	12:31		12:46			13:16	
PORT CREDIT	12.8			12:11	12:26		12:41			13:11	
CLARKSON	16.7			12:04	12:19		12:34			13:04	
OAKVILLE	21.4			11:56	12:11		12:26			12:56	
BRONTE	24.7			11:50			12:20			12:50	
APPLEBY	27.9			11:44			12:14			12:44	
BURLINGTON	31.5			11:37			12:07			12:37	
ALDRESHOT	34.6			11:31			12:01			12:31	
HAMILTON JCT	37.3										
WEST HARBOUR	39.3										
OAKVILLE SUBDIVISION											
DESJARDINS	60.1										
MAIN	58.9										
LOCKE	58.4										
PARK	57.6										
HAMILTON	57.5										
HAMILTON LAYOVER											
CP HAMILTON SUBDIVISION											
LEWIS RD LAYOVER	32.7										
GRIMSBY SUB											
CYCLE FROM		507	802	716	512	274	916	511	804	718	E279U
CYCLE TO		708	783	711	505	273	911	502	785	713	MY
Bus Connections											









EASTWARD		LAKESHORE - WEEKDAY									
Bus Connections											
CYCLE TO		723	E125W	889	475	923	DON	BR	477	E285	LI
STATIONS	Mile	516	E124	858	918LE	518	E519D	791	720	829	860
OSHAWA NORTH	11.6	14:56			15:11	15:26			15:41		
WHITBY NORTH	8.9	14:49			15:04	15:19			15:34		
AJAX NORTH	3.5	14:41			14:56	15:11			15:26		
PICKERING NORTH	1.0	14:36			14:51	15:06			15:21		
GO SUBDIVISION											
PICKERING SOUTH	312.9		
DURHAM JCT	313.9	(14:35)			(14:50)	(15:05)			(15:20)		
ROUGE HILL	317.3	14:28			14:43	14:58			15:13		
GUILDWOOD	321.2	14:23			14:38	14:53			15:08		
EGLINTON	323.2	14:18			14:33	14:48			15:03		
SCARBOROUGH	325.2	14:14		(14:28)	14:29	14:44			14:59		(15:24)
DANFORTH	328.6	14:08			14:23	14:38			14:53		
KINGSTON SUBDIVISION											
USRC											
SCOTT ST.	333.3		(14:19)	To Uxbridge Sub	Don Yd (14:51)	To Newmarket Sub	To Bala Sub	To Uxbridge Sub
TORONTO	333.8	13:58		14:15	14:13	14:28	(14:36)	14:40	14:43	15:10	15:11
CYCLE FROM		918LW	E858	E918	E518	519	806	520	278
CYCLE TO		E124	858	918LE	518	E519D	791	829	860
TORONTO	0.0	13:56	14:11	(13:54)	(14:00)	(14:23)	14:26	14:33	14:41	14:56	14:54
JOHN ST.	0.5	(13:54)	(14:07)	↑	↑	From BNY (14:13)	From Kingston Sub	From Newmarket Sub	(14:37)	(14:52)	From Weston Sub
USRC											
EXHIBITION	2.0	13:45	14:00						14:30	14:45	
MIMICO	6.7	13:39	13:54	(13:34)	(13:30)				14:24	14:39	
CANPA	8.4	
LONG BRANCH	9.6	13:31	13:46						14:16	14:31	
PORT CREDIT	12.8	13:26	13:41						14:11	14:26	
CLARKSON	16.7	13:19	13:34						14:04	14:19	
OAKVILLE	21.4	13:11	13:26						13:56	14:11	
BRONTE	24.7		13:20						13:50		
APPLEBY	27.9		13:14						13:44		
BURLINGTON	31.5		13:07						13:37		
ALDRESHOT	34.6		13:01						13:31		
HAMILTON JCT	37.3										
WEST HARBOUR	39.3										
OAKVILLE SUBDIVISION											
DESJARDINS	60.1										
MAIN	58.9										
LOCKE	58.4										
PARK	57.6										
HAMILTON	57.5										
HAMILTON LAYOVER											
CP HAMILTON SUBDIVISION											
LEWIS RD LAYOVER	32.7										
GRIMSBY SUB											
		516	918LW	E858	E918	E518	519	806	720	520	278
CYCLE FROM		509	913	WB	MY	BNY	508	787	715	513	277
Bus Connections											





































EASTWARD		LAKESHORE - WEEKDAY										
Bus Connections												
CYCLE TO		481LE	925	DON	GE	E149M	WB	E161	E151M	AE	LI	
STATIONS		Mile	E481O	920	E887D	203	149	E808W	722	151	795	862
OSHAWA NORTH	 11.6	(15:54)	16:13									
WHITBY NORTH	 8.9	(15:44)	16:06									
AJAX NORTH	 3.5		15:58									
PICKERING NORTH	 1.0		15:53									
GO SUBDIVISION												
PICKERING SOUTH	 312.9						16:21				
DURHAM JCT	313.9		(15:52)					(16:20)				
ROUGE HILL	 317.3		15:45					16:13				
GUILDWOOD	321.2		15:40					16:08				
EGLINTON	323.2		15:35					16:03				
SCARBOROUGH	 325.2		15:31					15:59				(16:36)
DANFORTH	 328.6		15:25					15:53				16:29
KINGSTON SUBDIVISION												To
USRC				Don Yd	To	To	To		To	To		Uxbridge
SCOTT ST.	333.3		(15:52)	Weston	Galt	Oakville	Galt	Newmkt		Sub
TORONTO	 333.8		15:15	(15:37)	15:35	15:40	(15:48)	15:43	16:10	16:10		16:18
CYCLE FROM			887	E203	E149	808	E151	E795		E862
CYCLE TO			E887D	203	149	E808W	151	795		862
TORONTO	 0.0		15:11	15:27	(15:20)	(15:25)	15:38	15:41	(15:48)	(15:55)		(15:50)
JOHN ST.	0.5		(15:06)	From	↑	↑	From	(15:37)	From	From		↑
USRC				Uxbridge			Newmarket		BNY	BNY		
EXHIBITION	 2.0		15:00	Sub			Sub		(15:38)	(15:40)		
MIMICO	6.7		14:54		(14:50)	(15:00)		15:30				(15:30)
CANPA	8.4					
LONG BRANCH	9.6		14:46					15:16				
PORT CREDIT	 12.8		14:41					15:11				
CLARKSON	 16.7		14:34					15:04				
OAKVILLE	 21.4		14:26					14:56				
BRONTE	 24.7		14:20					14:50				
APPLEBY	 27.9		14:14					14:44				
BURLINGTON	 31.5		14:07					14:37				
ALDRESHOT	 34.6		14:01					14:31				
HAMILTON JCT	37.3											
WEST HARBOUR	39.3											
OAKVILLE SUBDIVISION												
DESJARDINS	60.1											
MAIN	58.9											
LOCKE	58.4											
PARK	57.6											
HAMILTON	 57.5											
HAMILTON LAYOVER												
CP HAMILTON SUBDIVISION												
LEWIS RD LAYOVER	32.7											
GRIMSBY SUB												
			920	887	E203	E149	808	722	E151	E795		E862
CYCLE FROM			915	886	WB	WB	789	717	BNY	BNY		WB
Bus Connections												



























EASTWARD		LAKESHORE - WEEKDAY									
Bus Connections											
CYCLE TO		485	727	E831R	E153M	487	LI	927	AE	E833R	WRMF
STATIONS	Mile	424	922	831	153	426	864	724	799	833	428
OSHAWA NORTH	11.6	16:46	17:06			17:19		17:32			17:51
WHITBY NORTH	8.9	16:39	16:59			17:12		17:25			17:44
AJAX NORTH	3.5	16:33	16:53			17:06		17:19			17:38
PICKERING NORTH	1.0	16:28	16:48			17:01		17:14			17:33
GO SUBDIVISION											
PICKERING SOUTH	312.9
DURHAM JCT	313.9	(16:27)	(16:47)			(17:00)		(17:13)			(17:32)
ROUGE HILL	317.3	↑	16:40			↑		17:06			↑
GUILDWOOD	321.2		16:35					17:01			
EGLINTON	323.2		16:30					16:56			
SCARBOROUGH	325.2		16:26				17:06	↑			
DANFORTH	328.6		16:20				16:59				
KINGSTON SUBDIVISION											
USRC				To	To		To		To	To	
SCOTT ST.	333.3	Bala	Galt	Uxbridge	Newmkt	Bala
TORONTO	333.8	16:00	16:10	Sub	Sub	16:30	16:48	16:40	17:05	17:00	17:00
CYCLE FROM		E831	E153	282	E799	E833
CYCLE TO		831	153	864	799	833
TORONTO	0.0	15:55	16:08	16:10	(16:20)	16:25	16:39	16:38	(16:35)	(16:48)	16:55
JOHN ST.	0.5	(15:51)	(16:04)	From	From	(16:21)	From	(16:34)	From	↑	(16:51)
USRC				BNY	BNY		Weston		Kingston	↑	
EXHIBITION	2.0	15:44	15:57	(16:05)	(16:10)	16:14		16:27			16:44
MIMICO	6.7	15:38	15:51			16:08		16:21		(16:23)	16:38
CANPA	8.4
LONG BRANCH	9.6	15:30	15:43			16:00		16:13			16:30
PORT CREDIT	12.8	15:25	15:38			15:55		16:08			16:25
CLARKSON	16.7	15:18	15:31			15:48		16:01			16:18
OAKVILLE	21.4	15:10	15:23			15:40		15:53			16:10
BRONTE	24.7		15:17					15:47			
APPLEBY	27.9		15:11					15:41			
BURLINGTON	31.5		15:04					15:34			
ALDRESHOT	34.6		14:58					15:28			
HAMILTON JCT	37.3										
WEST HARBOUR	39.3										
OAKVILLE SUBDIVISION											
DESJARDINS	60.1										
MAIN	58.9										
LOCKE	58.4										
PARK	57.6										
HAMILTON	57.5										
HAMILTON LAYOVER											
CP HAMILTON SUBDIVISION											
LEWIS RD LAYOVER	32.7										
GRIMSBY SUB											
		424	922	E831	E153	426	282	724	E799	E833	428
CYCLE FROM		E424	917	BNY	BNY	E426	281	719	WRMF	WB	E428
Bus Connections											

EASTWARD		LAKESHORE - WEEKDAY									
Bus Connections											
CYCLE TO		729	929	LI	AE	WRMF	LI	KW	E163M	563	AE
STATIONS	Mile	430	924LE	866	803	432	868	211	163	726	801
OSHAWA NORTH	11.6		18:01			18:21				18:36	
WHITBY NORTH	8.9		17:54			18:14				18:29	
AJAX NORTH	3.5		17:48			18:08				18:23	
PICKERING NORTH	1.0		17:43			18:03				18:18	
GO SUBDIVISION			↑								
PICKERING SOUTH	312.9	17:56				
DURHAM JCT	313.9	(17:53)				(18:02)				(18:17)	
ROUGE HILL	317.3	17:48				↑				18:10	
GUILDWOOD	321.2	17:42								18:05	
EGLINTON	323.2	17:36								18:00	
SCARBOROUGH	325.2	17:31		(17:35)			(18:00)			17:56	
DANFORTH	328.6	17:25								17:50	
KINGSTON SUBDIVISION											
USRC											
SCOTT ST.	333.3	
TORONTO	333.8	17:15	17:15	17:20	18:05	17:35	17:45	17:50	17:55	17:40	17:35
CYCLE FROM		924LW	E924	E866	E803U	E432	E868	E211U	E163	E801
CYCLE TO		430	924LE	866	803	432	868	211	163	801
TORONTO	0.0	17:11	(17:05)	(17:10)	(17:20)	(17:25)	(17:27)	(17:36)	(17:42)	17:35	(17:23)
JOHN ST.	0.5	(17:09)	↑	↑	↑	↑	↑	↑	From Kingston Sub	(17:33)	Change at Scott Street
USRC											
EXHIBITION	2.0	17:00	↑	↑	↑	↑	↑	↑		17:27	↑
MIMICO	6.7	16:54	(16:25)	(16:30)		(16:50)	(16:57)	(17:00)		17:22	(16:45)
CANPA	8.4	
LONG BRANCH	9.6	16:46								17:14	
PORT CREDIT	12.8	16:41								17:09	
CLARKSON	16.7	16:34								17:02	
OAKVILLE	21.4	16:26								16:54	
BRONTE	24.7	16:20								16:48	
APPLEBY	27.9	16:14								16:42	
BURLINGTON	31.5	16:07								16:35	
ALDRESHOT	34.6	16:01			(16:38)					16:29	
HAMILTON JCT	37.3										
WEST HARBOUR	39.3										
OAKVILLE SUBDIVISION											
DESJARDINS	60.1										
MAIN	58.9										
LOCKE	58.4										
PARK	57.6										
HAMILTON	57.5										
HAMILTON LAYOVER											
CP HAMILTON SUBDIVISION											
LEWIS RD LAYOVER	32.7										
GRIMSBY SUB											
CYCLE FROM		924LW	E924	E866	E803U	E432	E868	E211U	E163	726	E801
CYCLE TO		919	WB	WB	471	MY	WB	WB	WRMF	E726	WB
Bus Connections											

EASTWARD		LAKESHORE - WEEKDAY									
Bus Connections											
CYCLE TO		731	E837R	LI	AE	ML	931	LI	E839R	KW	ML
STATIONS	Mile	434	837	870	805	165	926	872	839	289	167
OSHAWA NORTH	11.6	18:49					19:14				
WHITBY NORTH	8.9	18:42					19:07				
AJAX NORTH	3.5	18:36					18:59				
PICKERING NORTH	1.0	18:31					18:54				
GO SUBDIVISION											
PICKERING SOUTH	312.9				
DURHAM JCT	313.9	(18:27)					(18:53)				
ROUGE HILL	317.3	↑					18:46				
GUILDWOOD	321.2						18:40				
EGLINTON	323.2						18:35				
SCARBOROUGH	325.2			(18:28)			18:30	(18:48)			
DANFORTH	328.6			18:21			18:24	(18:46)			
				To				To			
KINGSTON SUBDIVISION											
USRC											
SCOTT ST.	333.3	To								
TORONTO	333.8	18:00	Bala				18:13	18:35	19:00	18:50	18:50
			Sub								
CYCLE FROM		E434	E872	E839	E289U	E167
CYCLE TO		434	E837	610	E805	E165	872	839	289	167
TORONTO	0.0	(17:45)	(17:47)	17:55	(18:10)	(18:11)	18:11	(18:15)	(18:30)	(18:35)	(18:40)
JOHN ST.	0.5	From	From	↑	↑	↑	(18:07)	↑	↑	↑	↑
		DY	BNY								
		(17:30)	(17:15)								
USRC											
EXHIBITION	2.0			17:37			18:00				
MIMICO	6.7			17:30	(17:40)	(17:50)	17:54	(17:55)	(17:57)	(18:15)	(18:20)
				(17:25)							
CANPA	8.4									
LONG BRANCH	9.6						17:46				
PORT CREDIT	12.8						17:41		From		
CLARKSON	16.7						17:34		WB		
OAKVILLE	21.4						17:26		C-Yard		
BRONTE	24.7						17:20				
APPLEBY	27.9						17:14				
BURLINGTON	31.5						17:07				
ALDRESHOT	34.6						17:01				
HAMILTON JCT	37.3										
WEST HARBOUR	39.3										
OAKVILLE SUBDIVISION											
DESJARDINS	60.1										
MAIN	58.9										
LOCKE	58.4										
PARK	57.6										
HAMILTON	57.5										
HAMILTON LAYOVER											
CP HAMILTON SUBDIVISION											
LEWIS RD LAYOVER	32.7										
GRIMSBY SUB											
		E434	E837	610	E805	E165	926	E872	E839	E289U	E167
CYCLE FROM		DY	BNY	WB	WB	WB	921	WB	WB	WB	WB
Bus Connections											

EASTWARD		LAKESHORE - WEEKDAY									
Bus Connections											
CYCLE TO	Mile	733	BR	933	LI	810	735	891	E894U	935	893
STATIONS	Mile	728	807	928	874	809	730	890	841	930	892
OSHAWA NORTH	11.6	19:41		20:15			20:46			21:11	
WHITBY NORTH	8.9	19:34		20:07			20:38			21:03	
AJAX NORTH	3.5	19:26		20:00			20:31			20:56	
PICKERING NORTH	1.0	19:21		19:55			20:26			20:51	
GO SUBDIVISION											
PICKERING SOUTH	312.9	
DURHAM JCT	313.9	(19:20)		(19:52)			(20:25)			(20:49)	
ROUGE HILL	317.3	19:13		19:47			20:18			20:43	
GUILDWOOD	321.2	19:08		19:42			20:13			20:38	
EGLINTON	323.2	19:03		19:37			20:08			20:33	
SCARBOROUGH	325.2	18:59		19:33	(19:32)		20:04	(20:13)		20:29	(20:43)
DANFORTH	328.6	18:53		19:27	(19:27)		19:58			20:23	
KINGSTON SUBDIVISION											
USRC			To Newmkt Sub		To Uxbridge Sub	To Newmkt Sub		To Uxbridge Sub	To Bala Sub		To Uxbridge Sub
SCOTT ST.	333.3	
TORONTO	333.8	18:43	19:05	19:17	19:18	19:40	19:48	20:00	20:00	20:13	20:30
CYCLE FROM		E807	E874U	E809U	E890U	E841	E892
CYCLE TO		807	874	809	890	841	892
TORONTO	0.0	18:41	18:50	19:11	(19:08)	(19:30)	19:46	(19:55)	(19:45)	20:11	(19:15)
JOHN ST.	0.5	(18:37)	↑	(19:07)	↑	From BNY (19:20)	(19:42)	From Don Yard Sub	↑	(20:07)	From Weston Sub
USRC											
EXHIBITION	2.0	18:30	↑	19:00	↑		19:35			20:00	
MIMICO	6.7	18:24	(18:25)	18:54	(18:43)		19:29		(19:20)	19:54	
CANPA	8.4	
LONG BRANCH	9.6	18:16		18:46			19:21			19:46	
PORT CREDIT	12.8	18:11		18:41			19:16			19:41	
CLARKSON	16.7	18:04		18:34			19:09			19:34	
OAKVILLE	21.4	17:56		18:26			19:01			19:26	
BRONTE	24.7	17:50		18:20			18:55			19:20	
APPLEBY	27.9	17:44		18:14			18:49			19:14	
BURLINGTON	31.5	17:37		18:07			18:42			19:07	
ALDRESHOT	34.6	17:31		18:01			18:36			19:01	
HAMILTON JCT	37.3										
WEST HARBOUR	39.3										
OAKVILLE SUBDIVISION											
DESJARDINS	60.1										
MAIN	58.9										
LOCKE	58.4										
PARK	57.6										
HAMILTON	57.5										
HAMILTON LAYOVER											
CP HAMILTON SUBDIVISION											
LEWIS RD LAYOVER	32.7										
GRIMSBY SUB											
		728	E807	928	E874U	E809U	730	E890U	E841	930	E892
CYCLE FROM		723	WB	923	MY	BNY	479	DY	WB	925	285
Bus Connections											

EASTWARD		LAKESHORE - WEEKDAY										
Bus Connections												
CYCLE TO		737	812	937	814	895	739	BR	939	LI	WRMF	
STATIONS		Mile	732	811	932	813	894	734	815	934	896	736
OSHAWA NORTH	 11.6	21:41		22:11			22:41		23:11		23:41	
WHITBY NORTH	 8.9	21:33		22:03			22:33		23:03		23:33	
AJAX NORTH	 3.5	21:26		21:56			22:26		22:56		23:26	
PICKERING NORTH	 1.0	21:21		21:51			22:21		22:51		23:21	
GO SUBDIVISION												
PICKERING SOUTH	 312.9	
DURHAM JCT	313.9	(20:20)		(21:49)			(22:20)		(22:49)		(23:20)	
ROUGE HILL	 317.3	21:13		21:43			22:13		22:43		23:13	
GUILDWOOD	321.2	21:08		21:38			22:08		22:38		23:08	
EGLINTON	323.2	21:03		21:33			22:03		22:33		23:03	
SCARBOROUGH	 325.2	20:59		21:29		(21:53)	21:59		22:29	(22:43)	22:59	
DANFORTH	 328.6	20:53		21:23			21:53		22:23		22:53	
KINGSTON SUBDIVISION												
USRC												
SCOTT ST.	333.3	To Newmkt Sub	To Newmkt Sub	To Uxbridge Sub	To Newmkt Sub	To Uxbridge Sub	
TORONTO	 333.8	20:43	20:40	21:13	21:40	21:40	21:43	22:40	22:13	22:30	22:43	
CYCLE FROM		E811	E813U	E894U	810	891	
CYCLE TO		811	813	894	815	896	
TORONTO	 0.0	20:41	20:30	21:11	(21:20)	(21:30)	21:41	21:33	22:11		22:41	
JOHN ST.	0.5	(20:37)	↑	(21:07)	From BNY (21:10)	From Bala Sub	(21:37)	From Newmarket Sub	(22:07)	From Uxbridge Sub	(22:37)	
USRC												
EXHIBITION	 2.0	20:30		21:00			21:30		22:00		22:30	
MIMICO	6.7	20:24		20:54			21:24		21:54		22:24	
CANPA	8.4	
LONG BRANCH	9.6	20:16		20:46			21:16		21:46		22:16	
PORT CREDIT	 12.8	20:11		20:41			21:11		21:41		22:11	
CLARKSON	 16.7	20:04		20:34			21:04		21:34		22:04	
OAKVILLE	 21.4	19:56		20:26			20:56		21:26		21:56	
BRONTE	 24.7	19:50		20:20			20:50		21:20		21:50	
APPLEBY	 27.9	19:44		20:14			20:44		21:14		21:44	
BURLINGTON	 31.5	19:37		20:07			20:37		21:07		21:37	
ALDRESHOT	 34.6	19:31	(19:38)	20:01			20:31		21:01		21:31	
HAMILTON JCT	37.3											
WEST HARBOUR	39.3											
OAKVILLE SUBDIVISION												
DESJARDINS	60.1											
MAIN	58.9											
LOCKE	58.4											
PARK	57.6											
HAMILTON	 57.5											
HAMILTON LAYOVER												
CP HAMILTON SUBDIVISION												
LEWIS RD LAYOVER	32.7											
GRIMSBY SUB												
		732	E811	932	E813U	E894U	734	810	934	891	736	
CYCLE FROM		E732	487	927	BNY	841	729	809	929	890	731	
Bus Connections												



EASTWARD		LAKESHORE - WEEKDAY									
Bus Connections											
CYCLE TO		WRMF	WRMF	WRMF	WRMF				WB	WB	
STATIONS	Mile	936	738	938	740				E4153W	E4157W	
OSHAWA NORTH	 11.6	00:11	00:41	01:11	01:41						
WHITBY NORTH	 8.9	00:03	00:33	01:03	01:33						
AJAX NORTH	 3.5	23:56	00:26	00:56	01:26						
PICKERING NORTH	 1.0	23:51	00:21	00:51	01:21						
GO SUBDIVISION											
PICKERING SOUTH	 312.9						
DURHAM JCT	313.9	(23:49)	(00:20)	(00:49)	(01:20)						
ROUGE HILL	 317.3	23:43	00:13	00:43	01:13						
GUILDWOOD	321.2	23:38	00:08	00:38	01:08						
EGLINTON	323.2	23:33	00:03	00:33	01:03						
SCARBOROUGH	 325.2	23:29	23:59	00:29	00:59						
DANFORTH	 328.6	23:23	23:53	00:23	00:53						
KINGSTON SUBDIVISION											
USRC									To Oakville Sub	To Oakville Sub	
SCOTT ST.	333.3						
TORONTO	 333.8	23:13	23:43	00:13	00:43				(01:38)	(02:08)	
CYCLE FROM				WB	E4153U	E4157U	
CYCLE TO					E4153W	E4157W	
TORONTO	 0.0	23:11	23:41	00:11	00:41				01:28	01:58	
JOHN ST.	0.5	(23:07)	(23:37)	(00:07)	(00:37)				From Weston Sub	From Weston Sub	
USRC											
EXHIBITION	 2.0	23:00	23:30	00:01	00:30						
MIMICO	6.7	22:54	23:24	23:54	00:24						
CANPA	8.4	(00:36)	(01:06)	(02:06)	(02:36)		
LONG BRANCH	9.6	22:46	23:16	23:46	00:16	↑	↑	↑	↑		
PORT CREDIT	 12.8	22:41	23:11	23:41	00:11						
CLARKSON	 16.7	22:34	23:04	23:34	00:04						
OAKVILLE	 21.4	22:26	22:56	23:26	23:56						
BRONTE	 24.7	22:20	22:50	23:20	23:50						
APPLEBY	 27.9	22:14	22:44	23:14	23:44						
BURLINGTON	 31.5	22:07	22:37	23:07	23:37						
ALDRESHOT	 34.6	22:01	22:31	23:01	23:31	(00:01)	(00:31)	(01:31)	(02:01)		
HAMILTON JCT	37.3										
WEST HARBOUR	39.3										
OAKVILLE SUBDIVISION											
DESJARDINS	60.1										
MAIN	58.9										
LOCKE	58.4										
PARK	57.6										
HAMILTON	 57.5										
HAMILTON LAYOVER											
CP HAMILTON SUBDIVISION											
LEWIS RD LAYOVER	32.7										
GRIMSBY SUB											
		936	738	938	740	E935W	E737W	E739W	E939W	E4153U	E4157U
CYCLE FROM		931	733	933	735	935	737	739	939	4153	4157
Bus Connections											





















EASTWARD		LAKESHORE - WEEKEND + HOLIDAY									
Bus Connections											
CYCLE TO				WB	WB	PE	PE	PE	PE	PE	705
STATIONS	Mile			E937	E939	4201	E4006	4203	4001	4003	E705
OSHAWA NORTH	11.6										(06:01)
WHITBY NORTH	8.9										(05:41)
AJAX NORTH	3.5										FROM
PICKERING NORTH	1.0										WRMF
GO SUBDIVISION											
PICKERING SOUTH	312.9										
DURHAM JCT	313.9										
ROUGE HILL	317.3										
GUILDWOOD	321.2										
EGLINTON	323.2										
SCARBOROUGH	325.2										
DANFORTH	328.6										
KINGSTON SUBDIVISION											
USRC						To Weston Sub	To Weston Sub	To Weston Sub	To Weston Sub	To Weston Sub	
SCOTT ST.	333.3										
TORONTO	333.8					04:55	(05:26)	05:10	(05:30)	(05:45)	
CYCLE FROM						E4201	E4006U	E4203	E4001	E4003	
CYCLE TO						4201	E4006	4203	4001	4003	
TORONTO	0.0					(04:46)	(05:16)	(05:01)	(05:10)	(05:35)	
JOHN ST.	0.5					↑	↑	↑	↑	↑	
USRC											
EXHIBITION	2.0					↑	↑	↑	↑	↑	
MIMICO	6.7					(04:21)	(04:51)	(04:41)	(04:50)	(05:15)	
CANPA	8.4	(00:36)	(01:06)	(01:36)	(02:36)						
LONG BRANCH	9.6	↑	↑	↑	↑						
PORT CREDIT	12.8										
CLARKSON	16.7										
OAKVILLE	21.4										
BRONTE	24.7										
APPLEBY	27.9										
BURLINGTON	31.5										
ALDRESHOT	34.6	(00:01)	(00:31)	(01:01)	(02:01)						
HAMILTON JCT	37.3										
WEST HARBOUR	39.3										
OAKVILLE SUBDIVISION											
DESJARDINS	60.1										
MAIN	58.9										
LOCKE	58.4										
PARK	57.6										
HAMILTON	57.5										
CP HAMILTON											
		E935W	E737W	E937W	E939W	E4201	E4006U	E4203	E4001	E4003	
CYCLE FROM		935	737	937	939	WB	WB	TMC	WB	WB	
Bus Connections											

EASTWARD		LAKESHORE - WEEKEND + HOLIDAY									
Bus Connections											
CYCLE TO		905	707	905	709	908	909	E123W	711	911	713
STATIONS	Mile	E905	E707	E907	E709	903	904	E122	706	906	708
OSHAWA NORTH	11.6	(06:31)	(07:01)	(07:31)	(08:01)		08:08		08:38	09:08	09:38
WHITBY NORTH	8.9	(06:11)	(06:41)	(07:11)	(07:41)		08:01		08:31	09:01	09:31
AJAX NORTH	3.5	FROM	FROM	FROM	FROM		07:54		08:24	08:54	09:24
PICKERING NORTH	1.0	WRMF	WRMF	WRMF	WRMF		07:49		08:19	08:49	09:19
GO SUBDIVISION											
PICKERING SOUTH	312.9					
DURHAM JCT	313.9										
ROUGE HILL	317.3						07:42		08:12	08:42	09:12
GUILDWOOD	321.2						07:37		08:07	08:37	09:07
EGLINTON	323.2						07:33		08:03	08:33	09:03
SCARBOROUGH	325.2						07:29		07:59	08:29	08:59
DANFORTH	328.6						07:23		07:53	08:23	08:53
KINGSTON SUBDIVISION											
USRC						To Oakville Sub		(07:20)			
SCOTT ST.	333.3										
TORONTO	333.8					06:43	07:13	↑	07:43	08:13	08:43
CYCLE FROM						E903	E904	
CYCLE TO						903	904	
TORONTO	0.0					06:30	07:05		07:40	08:10	08:40
JOHN ST.	0.5					↑	↑			(08:05)	
USRC						↑	↑				
EXHIBITION	2.0					(06:05)	(06:35)	(07:00)	07:30	08:00	08:30
MIMICO	6.7								07:24	07:54	08:24
CANPA	8.4							
LONG BRANCH	9.6								07:16	07:46	08:16
PORT CREDIT	12.8								07:11	07:41	08:11
CLARKSON	16.7								07:04	07:34	08:04
OAKVILLE	21.4								06:56	07:26	07:56
BRONTE	24.7								06:50	07:20	07:50
APPLEBY	27.9								06:44	07:14	07:44
BURLINGTON	31.5								06:37	07:07	07:37
ALDRESHOT	34.6								06:31	07:01	07:31
HAMILTON JCT	37.3										
WEST HARBOUR	39.3										
OAKVILLE SUBDIVISION											
DESJARDINS	60.1										
MAIN	58.9										
LOCKE	58.4										
PARK	57.6										
HAMILTON	57.5										
HAMILTON LAYOVER											
CP HAMILTON											
CYCLE FROM						E903	E904	E122	706	906	708
Bus Connections						WB	WB	WB	E706	WB	E708

EASTWARD		LAKESHORE - WEEKEND + HOLIDAY									
Bus Connections											
CYCLE TO		913	715	915	717	917	719	919	721	921	723
STATIONS	Mile	908	710	910	712	912	714	914	716	916	718
OSHAWA NORTH	11.6	10:08	10:38	11:08	11:38	12:08	12:38	13:08	13:38	14:08	14:38
WHITBY NORTH	8.9	10:01	10:31	11:01	11:31	12:01	12:31	13:01	13:31	14:01	14:31
AJAX NORTH	3.5	09:54	10:24	10:54	11:24	11:54	12:24	12:54	13:24	13:54	14:24
PICKERING NORTH	1.0	09:49	10:19	10:49	11:19	11:49	12:19	12:49	13:19	13:49	14:19
GO SUBDIVISION											
PICKERING SOUTH	312.9
DURHAM JCT	313.9										
ROUGE HILL	317.3	09:42	10:12	10:42	11:12	11:42	12:12	12:42	13:12	13:42	14:12
GUILDWOOD	321.2	09:37	10:07	10:37	11:07	11:37	12:07	12:37	13:07	13:37	14:07
EGLINTON	323.2	09:33	10:03	10:33	11:03	11:33	12:03	12:33	13:03	13:33	14:03
SCARBOROUGH	325.2	09:29	09:59	10:29	10:59	11:29	11:59	12:29	12:59	13:29	13:59
DANFORTH	328.6	09:23	09:53	10:23	10:53	11:23	11:53	12:23	12:53	13:23	13:53
KINGSTON SUBDIVISION											
USRC											
SCOTT ST.	333.3										
TORONTO	333.8	09:13	09:43	10:13	10:43	11:13	11:43	12:13	12:43	13:13	13:43
CYCLE FROM	
CYCLE TO	
TORONTO	0.0	09:10	09:40	10:10	10:40	11:10	11:40	12:10	12:40	13:10	13:40
JOHN ST.	0.5	(09:05)		(10:05)	(10:35)	(11:05)	(11:35)	(12:05)	(12:35)	(13:05)	(13:35)
USRC											
EXHIBITION	2.0	09:00	09:30	10:00	10:30	11:00	11:30	12:00	12:30	13:00	13:30
MIMICO	6.7	08:54	09:24	09:54	10:24	10:54	11:24	11:54	12:24	12:54	13:24
CANPA	8.4
LONG BRANCH	9.6	08:46	09:16	09:46	10:16	10:46	11:16	11:46	12:16	12:46	13:16
PORT CREDIT	12.8	08:41	09:11	09:41	10:11	10:41	11:11	11:41	12:11	12:41	13:11
CLARKSON	16.7	08:34	09:04	09:34	10:04	10:34	11:04	11:34	12:04	12:34	13:04
OAKVILLE	21.4	08:26	08:56	09:26	09:56	10:26	10:56	11:26	11:56	12:26	12:56
BRONTE	24.7	08:20	08:50	09:20	09:50	10:20	10:50	11:20	11:50	12:20	12:50
APPLEBY	27.9	08:14	08:44	09:14	09:44	10:14	10:44	11:14	11:44	12:14	12:44
BURLINGTON	31.5	08:07	08:37	09:07	09:37	10:07	10:37	11:07	11:37	12:07	12:37
ALDRSHOT	34.6	08:01	08:31	09:01	09:31	10:01	10:31	11:01	11:31	12:01	12:31
HAMILTON JCT	37.3										
WEST HARBOUR	39.3										
OAKVILLE SUBDIVISION											
DESJARDINS	60.1										
MAIN	58.9										
LOCKE	58.4										
PARK	57.6										
HAMILTON	57.5										
HAMILTON LAYOVER											
CP HAMILTON											
		908	710	910	712	912	714	914	716	916	718
CYCLE FROM		903	705	905	707	907	709	909	711	911	713
Bus Connections											







































EASTWARD		LAKESHORE - WEEKEND + HOLIDAY									
Bus Connections											
CYCLE TO		923	725	925	727	927	814	729	E811A	816	929
STATIONS	Mile	918	720	920	722	922	E814	724	811	E816	924
OSHAWA NORTH	11.6	15:08	15:38	16:08	16:38	17:08		17:38			18:08
WHITBY NORTH	8.9	15:01	15:31	16:01	16:31	17:01		17:31			18:01
AJAX NORTH	3.5	14:54	15:24	15:54	16:24	16:54		17:24			17:54
PICKERING NORTH	1.0	14:49	15:19	15:49	16:19	16:49		17:19			17:49
GO SUBDIVISION											
PICKERING SOUTH	312.9
DURHAM JCT	313.9										
ROUGE HILL	317.3	14:42	15:12	15:42	16:12	16:42		17:12			17:42
GUILDWOOD	321.2	14:37	15:07	15:37	16:07	16:37		17:07			17:37
EGLINTON	323.2	14:33	15:03	15:33	16:03	16:33		17:03			17:33
SCARBOROUGH	325.2	14:29	14:59	15:29	15:59	16:29		16:59			17:29
DANFORTH	328.6	14:23	14:53	15:23	15:53	16:23		16:53			17:23
KINGSTON SUBDIVISION											
USRC							To Newmkt Sub		To Newmkt Sub	To Newmkt Sub	
SCOTT ST.	333.3
TORONTO	333.8	14:13	14:43	15:13	15:43	16:13	(16:58)	16:43	17:00	(17:12)	17:13
CYCLE FROM		E814U	E811	E816U
CYCLE TO		E814	811	E816
TORONTO	0.0	14:10	14:40	15:10	15:40	16:10	(16:48)	16:40	16:50	(17:02)	17:10
JOHN ST.	0.5	(14:05)	(14:35)	(15:05)	(15:35)	(16:05)	↑	(16:35)	↑	From BNY (16:52)	(17:05)
USRC							↑		↑		
EXHIBITION	2.0	14:00	14:30	15:00	15:30	16:00	↑	16:30	↑		17:00
MIMICO	6.7	13:54	14:24	14:54	15:24	15:54	(16:18)	16:24	(16:30)		16:54
CANPA	8.4
LONG BRANCH	9.6	13:46	14:16	14:46	15:16	15:46		16:16			16:46
PORT CREDIT	12.8	13:41	14:11	14:41	15:11	15:41		16:11			16:41
CLARKSON	16.7	13:34	14:04	14:34	15:04	15:34		16:04			16:34
OAKVILLE	21.4	13:26	13:56	14:26	14:56	15:26		15:56			16:26
BRONTE	24.7	13:20	13:50	14:20	14:50	15:20		15:50			16:20
APPLEBY	27.9	13:14	13:44	14:14	14:44	15:14		15:44			16:14
BURLINGTON	31.5	13:07	13:37	14:07	14:37	15:07		15:37			16:07
ALDRESHOT	34.6	13:01	13:31	14:01	14:31	15:01		15:31			16:01
HAMILTON JCT	37.3										
WEST HARBOUR	39.3										
OAKVILLE SUBDIVISION											
DESJARDINS	60.1										
MAIN	58.9										
LOCKE	58.4										
PARK	57.6										
HAMILTON	57.5										
CP HAMILTON											
		918	720	920	722	922	E814U	724	E811	E816U	924
CYCLE FROM		913	715	915	717	917	WB	719	WB	BNY	919
Bus Connections											

EASTWARD		LAKESHORE - WEEKEND + HOLIDAY										
Bus Connections												
CYCLE TO		WB	731	731	931	733	933	735	935	737	937	
STATIONS	Mile	E726W	726LE	726	926	728	928	730	930	732	932	
OSHAWA NORTH	11.6		18:38	18:38	19:08	19:38	20:08	20:38	21:08	21:38	22:08	
WHITBY NORTH	8.9		18:31	18:31	19:01	19:31	20:01	20:31	21:01	21:31	22:01	
AJAX NORTH	3.5		18:24	18:24	18:54	19:24	19:54	20:24	20:54	21:24	21:54	
PICKERING NORTH	1.0		18:19	18:19	18:49	19:19	19:49	20:19	20:49	21:19	21:49	
GO SUBDIVISION												
PICKERING SOUTH	312.9	Effective Saturday ONLY	
DURHAM JCT	313.9											
ROUGE HILL	317.3		18:12	18:12	18:42	19:12	19:42	20:12	20:42	21:12	21:42	
GUILDWOOD	321.2		18:07	18:07	18:37	19:07	19:37	20:07	20:37	21:07	21:37	
EGLINTON	323.2		18:03	18:03	18:33	19:03	19:33	20:03	20:33	21:03	21:33	
SCARBOROUGH	325.2		17:59	17:59	18:29	18:59	19:29	19:59	20:29	20:59	21:29	
DANFORTH	328.6		17:53	17:53	18:23	18:53	19:23	19:53	20:23	20:53	21:23	
KINGSTON SUBDIVISION												
USRC		To Oakville Sub										
SCOTT ST.	333.3		
TORONTO	333.8		17:50	17:43	17:43	18:13	18:43	19:13	19:43	20:13	20:43	
CYCLE FROM		726LW	
CYCLE TO		E726W										
TORONTO	0.0		17:40	17:33	17:40	18:10	18:40	19:10	19:40	20:10	20:40	
JOHN ST.	0.5		(17:35)	↑	(17:35)	(18:05)	(18:35)	(19:05)	(19:35)	(20:05)	(20:35)	
USRC												
EXHIBITION	2.0	17:30	↑ (17:03)	17:30	18:00	18:30	19:00	19:30	20:00	20:30	21:00	
MIMICO	6.7	17:24		17:24	17:54	18:24	18:54	19:24	19:54	20:24	20:54	
CANPA	8.4	
LONG BRANCH	9.6	17:16		17:16	17:46	18:16	18:46	19:16	19:46	20:16	20:46	
PORT CREDIT	12.8	17:11		17:11	17:41	18:11	18:41	19:11	19:41	20:11	20:41	
CLARKSON	16.7	17:04		17:04	17:34	18:04	18:34	19:04	19:34	20:04	20:34	
OAKVILLE	21.4	16:56		16:56	17:26	17:56	18:26	18:56	19:26	19:56	20:26	
BRONTE	24.7	16:50		16:50	17:20	17:50	18:20	18:50	19:20	19:50	20:20	
APPLEBY	27.9	16:44		16:44	17:14	17:44	18:14	18:44	19:14	19:44	20:14	
BURLINGTON	31.5	16:37		16:37	17:07	17:37	18:07	18:37	19:07	19:37	20:07	
ALDRSHOT	34.6	16:31		16:31	17:01	17:31	18:01	18:31	19:01	19:31	20:01	
HAMILTON JCT	37.3											
WEST HARBOUR	39.3											
OAKVILLE SUBDIVISION												
DESJARDINS	60.1	Effective Saturday ONLY	Effective Saturday ONLY	Effective Sunday ONLY								
MAIN	58.9											
LOCKE	58.4											
PARK	57.6											
HAMILTON	57.5											
CP HAMILTON												
CYCLE FROM		726LW	E726	726	926	728	928	730	930	732	932	
Bus Connections												





































EASTWARD		LAKESHORE - WEEKEND + HOLIDAY									
Bus Connections											
CYCLE TO		739	939	WRMF	WRMF	WRMF	WRMF	WRMF		WB	WB
STATIONS	Mile	734	934	736	936	738	938	740		E4153W	E4157W
OSHAWA NORTH	11.6	22:38	23:08	23:38	00:08	00:38	01:08	01:38			
WHITBY NORTH	8.9	22:31	23:01	23:31	00:01	00:31	01:01	01:31			
AJAX NORTH	3.5	22:24	22:54	23:24	23:54	00:24	00:54	01:24			
PICKERING NORTH	1.0	22:19	22:49	23:19	23:49	00:19	00:49	01:19			
GO SUBDIVISION											
PICKERING SOUTH	312.9			
DURHAM JCT	313.9										
ROUGE HILL	317.3	22:12	22:42	23:12	23:42	00:12	00:42	01:12			
GUILDWOOD	321.2	22:07	22:37	23:07	23:37	00:07	00:37	01:07			
EGLINTON	323.2	22:03	22:33	23:03	23:33	00:03	00:33	01:03			
SCARBOROUGH	325.2	21:59	22:29	22:59	23:29	23:59	00:29	00:59			
DANFORTH	328.6	21:53	22:23	22:53	23:23	23:53	00:23	00:53			
KINGSTON SUBDIVISION											
										WB (02:03)	WB (02:33)
USRC											
SCOTT ST.	333.3			
TORONTO	333.8	21:43	22:13	22:43	23:13	23:43	00:13	00:43		(01:38)	(02:08)
CYCLE FROM			E4153U	E4157U
CYCLE TO			E4153W	E4157W
TORONTO	0.0	21:40	22:10	22:40	23:10	23:40	00:10	00:40		01:28	01:58
JOHN ST.	0.5	(21:35)	(22:05)	(22:35)	(23:05)	(23:35)	(00:05)	(00:35)		From Weston Sub	From Weston Sub
USRC											
EXHIBITION	2.0	21:30	22:00	22:30	23:00	23:30	00:01	00:30			
MIMICO	6.7	21:24	21:54	22:24	22:54	23:24	23:54	00:24			
CANPA	8.4	(02:06)		
LONG BRANCH	9.6	21:16	21:46	22:16	22:46	23:16	23:46	00:16	↑		
PORT CREDIT	12.8	21:11	21:41	22:11	22:41	23:11	23:41	00:11			
CLARKSON	16.7	21:04	21:34	22:04	22:34	23:04	23:34	00:04			
OAKVILLE	21.4	20:56	21:26	21:56	22:26	22:56	23:26	23:56			
BRONTE	24.7	20:50	21:20	21:50	22:20	22:50	23:20	23:50			
APPLEBY	27.9	20:44	21:14	21:44	22:14	22:44	23:14	23:44			
BURLINGTON	31.5	20:37	21:07	21:37	22:07	22:37	23:07	23:37			
ALDRSHOT	34.6	20:31	21:01	21:31	22:01	22:31	23:01	23:31	(01:31)		
HAMILTON JCT	37.3										
WEST HARBOUR	39.3										
OAKVILLE SUBDIVISION											
DESJARDINS	60.1										
MAIN	58.9										
LOCKE	58.4										
PARK	57.6										
HAMILTON	57.5										
HAMILTON LAYOVER											
CP HAMILTON											
		734	934	736	936	738	938	740	E739W	E4153U	E4157U
CYCLE FROM		729	929	731	931	733	933	735	739	4153	4157
Bus Connections											

WESTWARD		LAKESHORE - WEEKEND + HOLIDAY									
Bus Connections											
CYCLE FROM		MY	MY				WB	WRMF	WRMF	WRMF	WRMF
STATIONS	Mile	E4002U	E4006U				E903	705	905	707	907
GO SUBDIVISION											
OSHAWA NORTH	11.6							06:11	06:41	07:11	07:41
WHITBY NORTH	8.9							06:17	06:47	07:17	07:47
AJAX NORTH	3.5							06:24	06:54	07:24	07:54
PICKERING NORTH	1.0							06:30	07:00	07:30	08:00
KINGSTON SUBDIVISION							
PICKERING SOUTH	312.9										
DURHAM JCT	313.9										
ROUGE HILL	317.3							06:37	07:07	07:37	08:07
GUILDWOOD	321.2							06:43	07:13	07:43	08:13
EGLINTON	323.2							06:48	07:18	07:48	08:18
SCARBOROUGH	325.2							06:52	07:22	07:52	08:22
DANFORTH	328.6							06:57	07:27	07:57	08:27
USRC		(04:21)	(04:51)				From				
SCOTT ST.	333.3	From	From				WB		(07:35)		(08:35)
TORONTO	333.8	MCO Yard	MCO Yard					06:30	07:10	07:40	08:10
CYCLE TO		E4002	E4006			903
CYCLE FROM		E4002U	E4006U	WB	WB	WB	E903
TORONTO	0.0	(04:56)	(05:26)				06:43	07:13	07:43	08:13	08:43
JOHN ST.	0.5	To	To			
USRC		Weston	Weston								
		Sub	Sub								
OAKVILLE SUBDIVISION											
EXHIBITION	2.0						06:50	07:20	07:50	08:20	08:50
MIMICO	6.7						06:58	07:28	07:58	08:28	08:58
CANPA	8.4			(05:47)	(06:17)	(06:47)
LONG BRANCH	9.6			↓	↓	↓	07:04	07:34	08:04	08:34	09:04
PORT CREDIT	12.8			↓	↓	↓	07:10	07:40	08:10	08:40	09:10
CLARKSON	16.7			↓	↓	↓	07:16	07:46	08:16	08:46	09:16
OAKVILLE	21.4			↓	↓	↓	07:24	07:54	08:24	08:54	09:24
BRONTE	24.7			↓	↓	↓	07:30	08:00	08:30	09:00	09:30
APPLEBY	27.9			↓	↓	↓	07:37	08:07	08:37	09:07	09:37
BURLINGTON	31.5			↓	↓	↓	07:44	08:14	08:44	09:14	09:44
ALDRERSHOT	34.6			(06:21)	(06:51)	(07:21)	07:51	08:21	08:51	09:21	09:51
HAMILTON JCT	37.3										
WEST HARBOUR	39.3										
CP HAMILTON SUBDIVISION											
DESJARDINS	60.1										
MAIN	58.9										
LOCKE	58.4										
PARK	57.6										
HAMILTON	57.5										
HAMILTON LAYOVER											
		E4002	E4006	E706	E906	E708	903	705	905	707	907
CYCLE TO		PE	PE	706	906	708	908	710	910	712	912
Bus Connections											



























WESTWARD		LAKESHORE - WEEKEND + HOLIDAY									
Bus Connections											
CYCLE FROM		WRMF	904	706	906	708	908	710	910	712	912
STATIONS	Mile	709	909	711	911	713	913	715	915	717	917
GO SUBDIVISION											
OSHAWA NORTH	11.6	08:11	08:41	09:11	09:41	10:11	10:41	11:11	11:41	12:11	12:41
WHITBY NORTH	8.9	08:17	08:47	09:17	09:47	10:17	10:47	11:17	11:47	12:17	12:47
AJAX NORTH	3.5	08:24	08:54	09:24	09:54	10:24	10:54	11:24	11:54	12:24	12:54
PICKERING NORTH	1.0	08:30	09:00	09:30	10:00	10:30	11:00	11:30	12:00	12:30	13:00
KINGSTON SUBDIVISION											
PICKERING SOUTH	312.9
DURHAM JCT	313.9										
ROUGE HILL	317.3	08:37	09:07	09:37	10:07	10:37	11:07	11:37	12:07	12:37	13:07
GUILDWOOD	321.2	08:43	09:13	09:43	10:13	10:43	11:13	11:43	12:13	12:43	13:13
EGLINTON	323.2	08:48	09:18	09:48	10:18	10:48	11:18	11:48	12:18	12:48	13:18
SCARBOROUGH	325.2	08:52	09:22	09:52	10:22	10:52	11:22	11:52	12:22	12:52	13:22
DANFORTH	328.6	08:57	09:27	09:57	10:27	10:57	11:27	11:57	12:27	12:57	13:27
USRC											
SCOTT ST.	333.3		(09:35)	(10:05)		(11:05)	(11:35)	(12:05)	(12:35)	(13:05)	(13:35)
TORONTO	333.8	09:10	09:40	10:10	10:40	11:10	11:40	12:10	12:40	13:10	13:40
CYCLE TO	
CYCLE FROM	
TORONTO	0.0	09:13	09:43	10:13	10:43	11:13	11:43	12:13	12:43	13:13	13:43
JOHN ST.	0.5
USRC											
OAKVILLE SUBDIVISION											
EXHIBITION	2.0	09:20	09:50	10:20	10:50	11:20	11:50	12:20	12:50	13:20	13:50
MIMICO	6.7	09:28	09:58	10:28	10:58	11:28	11:58	12:28	12:58	13:28	13:58
CANPA	8.4
LONG BRANCH	9.6	09:34	10:04	10:34	11:04	11:34	12:04	12:34	13:04	13:34	14:04
PORT CREDIT	12.8	09:40	10:10	10:40	11:10	11:40	12:10	12:40	13:10	13:40	14:10
CLARKSON	16.7	09:46	10:16	10:46	11:16	11:46	12:16	12:46	13:16	13:46	14:16
OAKVILLE	21.4	09:54	10:24	10:54	11:24	11:54	12:24	12:54	13:24	13:54	14:24
BRONTE	24.7	10:00	10:30	11:00	11:30	12:00	12:30	13:00	13:30	14:00	14:30
APPLEBY	27.9	10:07	10:37	11:07	11:37	12:07	12:37	13:07	13:37	14:07	14:37
BURLINGTON	31.5	10:14	10:44	11:14	11:44	12:14	12:44	13:14	13:44	14:14	14:44
ALDRERSHOT	34.6	10:21	10:51	11:21	11:51	12:21	12:51	13:21	13:51	14:21	14:51
HAMILTON JCT	37.3										
WEST HARBOUR	39.3										
CP HAMILTON SUBDIVISION											
DESJARDINS	60.1										
MAIN	58.9										
LOCKE	58.4										
PARK	57.6										
HAMILTON	57.5										
HAMILTON LAYOVER											
		709	909	711	911	713	913	715	915	717	917
CYCLE TO		714	914	716	916	718	918	720	920	722	922
Bus Connections											





























WESTWARD		LAKESHORE - WEEKEND + HOLIDAY									
Bus Connections											
CYCLE FROM		714	E122	914	716	916	805	718	918	720	920
STATIONS	Mile	719	E123W	919	721	921	810	723	923	725	925
GO SUBDIVISION											
OSHAWA NORTH 	11.6	13:11		13:41	14:11	14:41		15:11	15:41	16:11	16:41
WHITBY NORTH 	8.9	13:17		13:47	14:17	14:47		15:17	15:47	16:17	16:47
AJAX NORTH 	3.5	13:24		13:54	14:24	14:54		15:24	15:54	16:24	16:54
PICKERING NORTH 	1.0	13:30		14:00	14:30	15:00		15:30	16:00	16:30	17:00
KINGSTON SUBDIVISION											
PICKERING SOUTH 	312.9										
DURHAM JCT 	313.9										
ROUGE HILL 	317.3	13:37		14:07	14:37	15:07		15:37	16:07	16:37	17:07
GUILDWOOD 	321.2	13:43		14:13	14:43	15:13		15:43	16:13	16:43	17:13
EGLINTON 	323.2	13:48		14:18	14:48	15:18		15:48	16:18	16:48	17:18
SCARBOROUGH 	325.2	13:52		14:22	14:52	15:22		15:52	16:22	16:52	17:22
DANFORTH 	328.6	13:57		14:27	14:57	15:27		15:57	16:27	16:57	17:27
USRC											
SCOTT ST.	333.3	(14:05)	(23:04)	(14:35)	(15:05)	(15:35)	From Newmarket Sub	(16:05)	(16:35)	(17:05)	(17:35)
TORONTO 	333.8	14:10		14:40	15:10	15:40		15:53	16:10	16:40	17:10
CYCLE TO							E810B				
CYCLE FROM							810				
TORONTO 	0.0	14:13		14:43	15:13	15:43	(16:03)	16:13	16:43	17:13	17:43
JOHN ST.	0.5						To BNY (16:18)				
USRC											
OAKVILLE SUBDIVISION							Temporary Storage				
EXHIBITION	2.0	14:20		14:50	15:20	15:50		16:20	16:50	17:20	17:50
MIMICO	6.7	14:28	(23:24)	14:58	15:28	15:58		16:28	16:58	17:28	17:58
CANPA	8.4										
LONG BRANCH	9.6	14:34		15:04	15:34	16:04		16:34	17:04	17:34	18:04
PORT CREDIT 	12.8	14:40		15:10	15:40	16:10		16:40	17:10	17:40	18:10
CLARKSON 	16.7	14:46		15:16	15:46	16:16		16:46	17:16	17:46	18:16
OAKVILLE 	21.4	14:54		15:24	15:54	16:24		16:54	17:24	17:54	18:24
BRONTE 	24.7	15:00		15:30	16:00	16:30		17:00	17:30	18:00	18:30
APPLEBY 	27.9	15:07		15:37	16:07	16:37		17:07	17:37	18:07	18:37
BURLINGTON 	31.5	15:14		15:44	16:14	16:44		17:14	17:44	18:14	18:44
ALDRESHOT 	34.6	15:21		15:51	16:21	16:51		17:21	17:51	18:21	18:51
HAMILTON JCT	37.3										
WEST HARBOUR	39.3										
CP HAMILTON SUBDIVISION											
DESJARDINS	60.1										
MAIN	58.9										
LOCKE	58.4										
PARK	57.6										
HAMILTON 	57.5										
HAMILTON LAYOVER											
		719	E123W	919	721	921	E810B	723	923	725	925
CYCLE TO		724	WB	924	726	926	BNY	728	928	730	930
Bus Connections											

WESTWARD		LAKESHORE - WEEKEND + HOLIDAY									
Bus Connections											
CYCLE FROM		721	722	922	724	924	726	926	728	928	730
STATIONS	Mile	726LW	727	927	729	929	731	931	733	933	735
GO SUBDIVISION											
OSHAWA NORTH	11.6		17:11	17:41	18:11	18:41	19:11	19:41	20:11	20:41	21:11
WHITBY NORTH	8.9		17:17	17:47	18:17	18:47	19:17	19:47	20:17	20:47	21:17
AJAX NORTH	3.5		17:24	17:54	18:24	18:54	19:24	19:54	20:24	20:54	21:24
PICKERING NORTH	1.0		17:30	18:00	18:30	19:00	19:30	20:00	20:30	21:00	21:30
KINGSTON SUBDIVISION		
PICKERING SOUTH	312.9										
DURHAM JCT	313.9										
ROUGE HILL	317.3		17:37	18:07	18:37	19:07	19:37	20:07	20:37	21:07	21:37
GUILDWOOD	321.2		17:43	18:13	18:43	19:13	19:43	20:13	20:43	21:13	21:43
EGLINTON	323.2		17:48	18:18	18:48	19:18	19:48	20:18	20:48	21:18	21:48
SCARBOROUGH	325.2		17:52	18:22	18:52	19:22	19:52	20:22	20:52	21:22	21:52
DANFORTH	328.6		17:57	18:27	18:57	19:27	19:57	20:27	20:57	21:27	21:57
USRC											
SCOTT ST.	333.3	From Oakville Sub	(18:05)	(18:35)	(19:05)	(19:35)	(20:05)	(20:35)	(21:05)	(21:35)	(22:05)
TORONTO	333.8		17:40	18:10	18:40	19:10	19:40	20:10	20:40	21:10	21:40
CYCLE TO		E726W
CYCLE FROM		726LW
TORONTO	0.0		17:50	18:13	18:43	19:13	19:43	20:13	20:43	21:13	21:43
JOHN ST.	0.5	
USRC											
OAKVILLE SUBDIVISION											
EXHIBITION	2.0	↓	18:20	18:50	19:20	19:50	20:20	20:50	21:20	21:50	22:20
MIMICO	6.7	(18:10)	18:28	18:58	19:28	19:58	20:28	20:58	21:28	21:58	22:28
CANPA	8.4	
LONG BRANCH	9.6		18:34	19:04	19:34	20:04	20:34	21:04	21:34	22:04	22:34
PORT CREDIT	12.8		18:40	19:10	19:40	20:10	20:40	21:10	21:40	22:10	22:40
CLARKSON	16.7		18:46	19:16	19:46	20:16	20:46	21:16	21:46	22:16	22:46
OAKVILLE	21.4		18:54	19:24	19:54	20:24	20:54	21:24	21:54	22:24	22:54
BRONTE	24.7		19:00	19:30	20:00	20:30	21:00	21:30	22:00	22:30	23:00
APPLEBY	27.9		19:07	19:37	20:07	20:37	21:07	21:37	22:07	22:37	23:07
BURLINGTON	31.5		19:14	19:44	20:14	20:44	21:14	21:44	22:14	22:44	23:14
ALDRERSHOT	34.6		19:21	19:51	20:21	20:51	21:21	21:51	22:21	22:51	23:21
HAMILTON JCT	37.3										
WEST HARBOUR	39.3										
CP HAMILTON SUBDIVISION											
DESJARDINS	60.1	Effective Saturday ONLY									
MAIN	58.9										
LOCKE	58.4										
PARK	57.6										
HAMILTON	57.5										
HAMILTON LAYOVER											
CYCLE TO		E726W	727	927	729	929	731	931	733	933	735
Bus Connections		WB	732	932	734	934	736	936	738	938	740































WESTWARD		LAKESHORE - WEEKEND + HOLIDAY									
Bus Connections											
CYCLE FROM		930	819	732	932	734	934	736	936	738	938
STATIONS	Mile	935	824	737	937	739	939	E736X	E936X	E738X	E938X
GO SUBDIVISION											
OSHAWA NORTH 	11.6	21:41		22:11	22:41	23:11	23:41	(23:48)	(00:18)	(00:48)	(01:18)
WHITBY NORTH 	8.9	21:47		22:17	22:47	23:17	23:47	(00:08)	(00:38)	(01:08)	(01:38)
AJAX NORTH 	3.5	21:54		22:24	22:54	23:24	23:54	TO	TO	TO	TO
PICKERING NORTH 	1.0	22:00		22:30	23:00	23:30	00:01	WRMF	WRMF	WRMF	WRMF
KINGSTON SUBDIVISION											
PICKERING SOUTH 	312.9				
DURHAM JCT	313.9										
ROUGE HILL 	317.3	22:07		22:37	23:07	23:37	00:07				
GUILDWOOD 	321.2	22:13		22:43	23:13	23:43	00:13				
EGLINTON 	323.2	22:18		22:48	23:18	23:48	00:18				
SCARBOROUGH 	325.2	22:22		22:52	23:22	23:52	00:22				
DANFORTH 	328.6	22:27		22:57	23:27	23:57	00:27				
USRC											
SCOTT ST.	333.3	(22:35)	From Newmarket Sub	(23:05)	(23:35)	(00:05)	(00:35)				
TORONTO 	333.8	22:40	23:03	23:10	23:40	00:10	00:40				
CYCLE TO		E824W				
CYCLE FROM		824				
TORONTO 	0.0	22:43	(23:13)	23:13	23:43	00:13	00:43				
JOHN ST.	0.5	↓				
USRC											
OAKVILLE SUBDIVISION											
EXHIBITION	2.0	22:50	↓	23:20	23:50	00:20	00:50				
MIMICO	6.7	22:58	(23:33)	23:28	23:58	00:28	00:58				
CANPA	8.4				
LONG BRANCH	9.6	23:04		23:34	0:04	00:34	01:04				
PORT CREDIT 	12.8	23:10		23:40	0:10	00:40	01:10				
CLARKSON 	16.7	23:16		23:46	0:16	00:46	01:16				
OAKVILLE 	21.4	23:24		23:54	0:24	00:54	01:24				
BRONTE 	24.7	23:30		0:00	0:30	01:00	01:30				
APPLEBY 	27.9	23:37		0:07	0:37	01:07	01:37				
BURLINGTON 	31.5	23:44		0:14	0:44	01:14	01:44				
ALDRESHOT 	34.6	23:51		0:21	0:51	01:21	01:51				
HAMILTON JCT	37.3										
WEST HARBOUR	39.3										
CP HAMILTON SUBDIVISION											
DESJARDINS	60.1										
MAIN	58.9										
LOCKE	58.4										
PARK	57.6										
HAMILTON 	57.5										
HAMILTON LAYOVER											
		935	E824W	737	937	739	939				
CYCLE TO		E935W	WB	E737W	E937W	E739W	E939W				
Bus Connections											



























WESTWARD		LAKESHORE - WEEKEND + HOLIDAY					
Bus Connections							
CYCLE FROM		740	4149	4151	4153	4155	4157
STATIONS	Mile	E740X	4156	4158	E4153U	E4155U	E4157U
GO SUBDIVISION							
OSHAWA NORTH	11.6	(01:48)					
WHITBY NORTH	8.9	(02:08)					
AJAX NORTH	3.5	TO WRMF					
PICKERING NORTH	1.0						
KINGSTON SUBDIVISION							
PICKERING SOUTH	312.9						
DURHAM JCT	313.9						
ROUGE HILL	317.3						
GUILDWOOD	321.2						
EGLINTON	323.2						
SCARBOROUGH	325.2						
DANFORTH	328.6						
USRC							
SCOTT ST.	333.3		From Weston Sub	From Weston Sub	From Weston Sub	From Weston Sub	From Weston Sub
TORONTO	333.8		01:07	01:22	01:28	01:43	01:58
CYCLE TO			E4156T	E4158W	E4153W	E4155W	E4157W
CYCLE FROM			4156	4158	E4153U	E4155U	E4157U
TORONTO	0.0		01:17	01:32	(01:38)	01:53	(02:08)
JOHN ST.	0.5						
USRC							
OAKVILLE SUBDIVISION							
EXHIBITION	2.0		↓	↓	↓	↓	↓
MIMICO	6.7		(01:37)	(01:52)	(02:03)	(02:13)	(02:33)
CANPA	8.4						
LONG BRANCH	9.6						
PORT CREDIT	12.8						
CLARKSON	16.7						
OAKVILLE	21.4						
BRONTE	24.7						
APPLEBY	27.9						
BURLINGTON	31.5						
ALDRESHOT	34.6						
HAMILTON JCT	37.3						
WEST HARBOUR	39.3						
CP HAMILTON SUBDIVISION							
DESJARDINS	60.1						
MAIN	58.9						
LOCKE	58.4						
PARK	57.6						
HAMILTON	57.5						
HAMILTON LAYOVER							
			E4156T	E4158W	E4153W	E4155W	E4157W
CYCLE TO			TMC	WB	WB	WB	WB
Bus Connections							





























Barrie Corridor		SOUTHWARD WEEKDAY SERVICE						
WESTON SUBDIVISION	CYCLE TO	E258	554	556	WB	WB	WR	WB
	SIZE	L6	L10	L12	L12	L12	L12	L12
	Mile	780	782	784	786	788	790	792
 TORONTO  JOHN ST BATHURST ST STRACHAN Jct with CPR PARKDALE Jct with Newmarket Sub	0.0	06:33	07:03	07:33	07:47	08:03	08:19	08:33
	0.5	(06:28)	(06:58)	(07:28)	(07:42)	(07:58)	(08:14)	(08:28)
	1.1	↑	↑	↑	↑	↑	↑	↑
	1.5	↑	↑	↑	↑	↑	↑	↑
	1.9	↑	↑	↑	↑	↑	↑	↑
	3.0	↑	↑	↑	↑	↑	↑	↑
NEWMARKET SUBDIVISION								
	3.0	↑	↑	↑	↑	↑	↑	↑
	4.6	(06:19)	(06:49)	(07:19)	(07:34)	(07:49)	(08:04)	(08:19)
	6.4							
 DOWNSVIEW PARK  SNIDER SOUTH	10.8	06:13	06:43	07:13	07:27	07:43	07:57	08:13
	12.1	↑						
 YORK UNIVERSITY  SNIDER	12.6	↑	06:39	07:09	07:23	07:39	07:53	08:09
	12.9	↑						
 RUTHERFORD   MAPLE 	16.7	06:04	06:32	07:02	07:17	07:32	07:47	08:02
	18.3	06:00	06:28	06:58	07:13	07:28	07:43	07:58
	18.5							
 KING CITY   AURORA 	22.7	05:52	06:20	06:50	07:05	07:20	07:35	07:50
	29.9	05:41	06:09	06:39	06:54	07:09	07:24	07:39
 NEWMARKET   EAST GWILLIMBURY 	34.2	05:33	06:01	06:31	06:46	07:01	07:16	07:31
	35.5	05:29	05:57	06:27	06:42	06:57	07:12	07:27
 BRADFORD  BRADFORD LAYOVER	41.5	05:19	05:47	06:17	06:32	06:47	07:02	07:17
	41.5	(04:50)						
	51.9							
 BARRIE SOUTH   ALLANDALE WATERFRONT 	59.5		05:26	05:56	06:11	06:26	06:41	06:56
	63.0		05:18	05:48	06:03	06:18	06:33	06:48
	62.5		(05:03)	(05:33)	(05:48)	(06:03)	(06:18)	(06:33)
		780	782	784	786	788	790	792
	CYCLE FROM	Bradford	Allandale	Allandale	Allandale	Allandale	Allandale	Allandale
Bus Connections								



























Barrie Corridor		SOUTHWARD WEEKDAY SERVICE						
WESTON SUBDIVISION	CYCLE TO	500	271	273	275	277	WB	
	SIZE	L12	L10	L6	L6	L6	L6	
	Mile	794	796	798	800	802	804	
 TORONTO  JOHN ST BATHURST ST STRACHAN Jct with CPR PARKDALE Jct with Newmarket Sub	0.0	09:03	09:33	10:33	11:33	12:33	13:33	
	0.5	(08:58)	(09:28)	(10:28)	(11:28)	(12:28)	(13:28)	
	1.1	↑	↑	↑	↑	↑	↑	
	1.5	↑	↑	↑	↑	↑	↑	
	1.9	↑	↑	↑	↑	↑	↑	
	3.0	↑	↑	↑	↑	↑	↑	
	NEWMARKET SUBDIVISION							
	PARKDALE Jct with Weston Sub	3.0						
	DAVENPORT	4.6	(08:49)	(09:19)	(10:19)	(11:19)	(12:19)	(13:19)
	FAIRBANK	6.4						
 DOWNSVIEW PARK 	10.8	08:43	09:13	10:13	11:13	12:13	13:13	
SNIDER SOUTH	12.1			↑	↑	↑	↑	
 YORK UNIVERSITY 	12.6	08:39	09:09	↑	↑	↑	↑	
SNIDER	12.9			↑	↑	↑	↑	
SNIDER NORTH	14.0			↑	↑	↑	↑	
 RUTHERFORD 	16.7	08:32	09:02	10:04	11:04	12:04	13:04	
 MAPLE 	18.3	08:28	08:58	10:00	11:00	12:00	13:00	
TESTON	18.5							
 KING CITY 	22.7	08:20	08:50	09:52	10:52	11:52	12:52	
 AURORA 	29.9	08:09	08:39	09:41	10:41	11:41	12:41	
 NEWMARKET 	34.2	08:01	08:31	09:33				
 EAST GWILLIMBURY 	35.5	07:57	08:27	09:29				
 BRADFORD 	41.5	07:47	08:17	09:19				
BRADFORD LAYOVER			(07:48)	(08:50)				
LEFROY	51.9							
 BARRIE SOUTH 	59.5	07:26						
 ALLANDALE WATERFRONT 	63.0	07:18						
LAYOVER YARD	62.5	(07:03)						
		794	796	798	800	802	804	
	CYCLE FROM	Allandale	Bradford	Bradford	781	783	785	
Bus Connections	   							







Barrie Corridor		SOUTHWARD WEEKDAY SERVICE				
WESTON SUBDIVISION	CYCLE TO	791	WB	815	WB	WB
	SIZE	L6	L6	L10	L12	L12
	Mile	806	808	810	812	814
♿ TORONTO JOHN ST BATHURST ST STRACHAN <small>Jct with CPR</small> PARKDALE <small>Jct with Newmarket Sub</small> ♿	0.0	14:33	15:38	21:33	22:33	23:33
	0.5	(14:28)	(15:33)	(21:28)	(22:28)	(23:28)
	1.1	↑	↑	↑	↑	↑
	1.5					
	1.9					
	3.0					
NEWMARKET SUBDIVISION						
PARKDALE <small>Jct with Weston Sub</small> DAVENPORT FAIRBANK ♿ DOWNSVIEW PARK SNIDER SOUTH ♿ ♿ YORK UNIVERSITY SNIDER SNIDER NORTH ♿ ♿ RUTHERFORD MAPLE ♿ TESTON ♿ KING CITY ♿ ♿ AURORA ♿ ♿ NEWMARKET ♿ ♿ EAST GWILLIMBURY ♿ ♿ BRADFORD BRADFORD LAYOVER LEFROY ♿ BARRIE SOUTH ♿ ♿ ALLANDALE WATERFRONT LAYOVER YARD ♿	3.0					
	4.6	(14:19)	(15:19)	(21:19)	(22:19)	(23:19)
	6.4					
	10.8	14:13	15:13	21:13	22:13	23:13
	12.1	↑	↑	↑	↑	↑
	12.6					
	12.9					
	14.0					
	16.7	14:04	15:04	21:04	22:04	23:04
	18.3	14:00	15:00	21:00	22:00	23:00
	18.5					
	22.7	13:52	14:52	20:52	21:52	22:52
	29.9	13:41	14:41	20:41	21:41	22:41
	34.2					
	35.5					
41.5						
51.9						
59.5						
63.0						
62.5						
		806	808	810	812	814
CYCLE FROM		787	789	809	811	813
Bus Connections						









Barrie Corridor		NORTHWARD WEEKDAY SERVICE							
WESTON SUBDIVISION		CYCLE FROM	873	875	877	881	883	806	
		SIZE	L6	L6	L6	L6	L6	L6	
		Mile	781	783	785	787	789	791	
	TORONTO		0.0	09:40	10:40	11:40	12:40	13:40	14:40
	JOHN ST		0.5
	BATHURST ST		1.1	↓	↓	↓	↓	↓	↓
	STRACHAN		1.5	↓	↓	↓	↓	↓	↓
	Jct with CPR		1.9	↓	↓	↓	↓	↓	↓
	PARKDALE		3.0	↓	↓	↓	↓	↓	↓
	Jct with Newmarket Sub								
NEWMARKET SUBDIVISION									
	PARKDALE		3.0	↓	↓	↓	↓	↓	↓
	Jct with Weston Sub								
	DAVENPORT		4.6	(09:49)	(10:49)	(11:49)	(12:49)	(13:49)	(14:49)
	FAIRBANK		6.4						
	DOWNSVIEW PARK		10.8	09:58	10:58	11:58	12:58	13:58	14:58
	SNIDER SOUTH		12.1						
	YORK UNIVERSITY		12.6	↓	↓	↓	↓	↓	↓
	SNIDER		12.9	↓	↓	↓	↓	↓	↓
	SNIDER NORTH		14.0						
	RUTHERFORD		16.7	10:08	11:08	12:08	13:08	14:08	15:08
	MAPLE		18.3	10:13	11:13	12:13	13:13	14:13	15:13
	TESTON		18.5						
	KING CITY		22.7	10:20	11:20	12:20	13:20	14:20	15:20
	AURORA		29.9	10:31	11:31	12:31	13:31	14:31	15:31
	NEWMARKET		34.2						15:39
	EAST GWILLIMBURY		35.5						15:43
	BRADFORD		41.5						15:51
	BRADFORD LAYOVER								(16:11)
	LEFROY		51.9						
	BARRIE SOUTH		59.5						
	ALLANDALE WATERFRONT		63.0						
	LAYOVER YARD		62.5						
			781	783	785	787	789	791	
		CYCLE TO	800	802	804	806	808	Bradford	
Bus Connections									





Barrie Corridor		NORTHWARD WEEKDAY SERVICE					
WESTON SUBDIVISION	CYCLE FROM	721LE	BNY	DON	WR	WB	SCOTT
	SIZE	L12	L12	L12	L12	L12	L12
	Mile	793	795	797	799	801	803
 TORONTO  JOHN ST BATHURST ST STRACHAN Jct with CPR PARKDALE Jct with Newmarket Sub	0.0 0.5 1.1 1.5 1.9 3.0	15:40	16:10	16:40	17:05	17:35	18:05
NEWMARKET SUBDIVISION							
PARKDALE Jct with Weston Sub DAVENPORT FAIRBANK  DOWNSVIEW PARK  SNIDER SOUTH  YORK UNIVERSITY  SNIDER SNIDER NORTH  RUTHERFORD   MAPLE  TESTON  KING CITY   AURORA   NEWMARKET   EAST GWILLIMBURY   BRADFORD  BRADFORD LAYOVER LEFROY  BARRIE SOUTH   ALLANDALE WATERFRONT  LAYOVER YARD	3.0 4.6 6.4 10.8 12.1 12.6 12.9 14.0 16.7 18.3 18.5 22.7 29.9 34.2 35.5 41.5 51.9 59.5 63.0 62.5	↓ (15:49) ↓ 15:58 ↓ 16:02 ↓ 16:11 ↓ 16:16 ↓ 16:25 ↓ 16:36 ↓ 16:44 ↓ 16:48 ↓ 16:57 ↓ 17:16 ↓ 17:26 (17:41)	↓ (16:19) ↓ 16:28 ↓ 16:32 ↓ 16:41 ↓ 16:46 ↓ 16:55 ↓ 17:06 ↓ 17:14 ↓ 17:18 ↓ 17:27 ↓ 17:46 ↓ 17:56 (18:11)	↓ (16:49) ↓ 16:58 ↓ 17:02 ↓ 17:11 ↓ 17:16 ↓ 17:25 ↓ 17:36 ↓ 17:44 ↓ 17:48 ↓ 17:57 ↓ 18:16 ↓ 18:26 (18:41)	↓ (17:14) ↓ 17:23 ↓ 17:27 ↓ 17:36 ↓ 17:41 ↓ 17:50 ↓ 18:01 ↓ 18:09 ↓ 18:13 ↓ 18:22 ↓ 18:41 ↓ 18:51 (19:06)	↓ (17:44) ↓ 17:53 ↓ 17:57 ↓ 18:06 ↓ 18:11 ↓ 18:20 ↓ 18:31 ↓ 18:39 ↓ 18:43 ↓ 18:52 ↓ 19:11 ↓ 19:21 (19:36)	↓ (18:14) ↓ 18:23 ↓ 18:27 ↓ 18:36 ↓ 18:41 ↓ 18:50 ↓ 19:01 ↓ 19:09 ↓ 19:13 ↓ 19:22 ↓ 19:41 ↓ 19:51 (20:06)
		793	795	797	799	801	803
	CYCLE TO	Allandale	Allandale	Allandale	Allandale	Allandale	Allandale
Bus Connections							



Barrie Corridor		NORTHWARD WEEKDAY SERVICE					
WESTON SUBDIVISION	CYCLE FROM	WB	WB	BNY	E811	E813U	810
	SIZE	L10	L6	L10	L12	L12	L10
	Mile	805	807	809	811	813	815
 TORONTO  JOHN ST BATHURST ST STRACHAN Jct with CPR PARKDALE Jct with Newmarket Sub	0.0 0.5 1.1 1.5 1.9 3.0	18:35 ↓ ↓ ↓ ↓	19:05 ↓ ↓ ↓ ↓	19:40 ↓ ↓ ↓ ↓	20:40 ↓ ↓ ↓ ↓	21:40 ↓ ↓ ↓ ↓	22:40 ↓ ↓ ↓ ↓
NEWMARKET SUBDIVISION							
PARKDALE Jct with Weston Sub DAVENPORT FAIRBANK  DOWNSVIEW PARK  SNIDER SOUTH  YORK UNIVERSITY  SNIDER SNIDER NORTH  RUTHERFORD   MAPLE  TESTON  KING CITY   AURORA   NEWMARKET   EAST GWILLIMBURY   BRADFORD  BRADFORD LAYOVER LEFROY  BARRIE SOUTH   ALLANDALE WATERFRONT  LAYOVER YARD	3.0 4.6 6.4 10.8 12.1 12.6 12.9 14.0 16.7 18.3 18.5 22.7 29.9 34.2 35.5 41.5 51.9 59.5 63.0 62.5	↓ (18:44) ↓ 18:53 ↓ 18:57 ↓ ↓ ↓ 19:06 19:11 ↓ 19:20 19:31 19:39 19:43 19:52 ↓ 20:11 20:21 (20:36)	↓ (19:14) ↓ 19:23 ↓ 19:27 ↓ ↓ ↓ 19:35 19:40 ↓ 19:47 19:58 20:06 20:10 20:18 (20:38) ↓ ↓ ↓ ↓	↓ (19:49) ↓ 19:58 ↓ ↓ ↓ ↓ 20:08 20:13 ↓ 20:20 20:31 ↓ ↓ ↓ ↓ ↓ ↓ ↓ ↓	↓ (20:49) ↓ 20:58 ↓ ↓ ↓ ↓ 21:08 21:13 ↓ 21:20 21:31 ↓ ↓ ↓ ↓ ↓ ↓ ↓ ↓	↓ (21:49) ↓ 21:58 ↓ ↓ ↓ ↓ 22:08 22:13 ↓ 22:20 22:31 ↓ ↓ ↓ ↓ ↓ ↓ ↓ ↓	↓ (22:49) ↓ 22:58 ↓ ↓ ↓ ↓ 23:08 23:13 ↓ 23:20 23:31 23:39 23:43 23:51 (00:11) ↓ ↓ ↓ ↓
		805	807	809	811	813	815
	CYCLE TO	Allandale	Bradford	810	812	814	Bradford
Bus Connections		    					











Barrie Corridor		SOUTHWARD							
WESTON		WEEKEND SERVICE							
SUBDIVISION		CYCLE TO	801	803	805	807	809	BNY	813
		SIZE	L12	L12	L12	L12	L12	L12	L12
		Mile	800	802	804	806	808	810	812
 <p>TORONTO JOHN ST BATHURST ST STRACHAN Jct with CPR PARKDALE Jct with Newmarket Sub</p> 	0.0	10:53	11:53	12:53	13:53	14:53	15:53	16:53	
	0.5	(10:48)	(11:48)	(12:48)	(13:48)	(14:48)	(15:48)	(16:48)	
	1.1	↑	↑	↑	↑	↑	↑	↑	
	1.5								
	1.9								
	3.0								
NEWMARKET									
SUBDIVISION									
	3.0								
	4.6	(10:39)	(11:39)	(12:39)	(13:39)	(14:39)	(15:39)	(16:39)	
	6.4								
 <p>DOWNSVIEW PARK SNIDER SOUTH</p> 	10.8	10:31	11:31	12:31	13:31	14:31	15:31	16:31	
	12.1	↑	↑	↑	↑	↑	↑	↑	
 <p>YORK UNIVERSITY SNIDER</p> 	12.6								
	12.9								
 <p>SNIDER NORTH RUTHERFORD</p> 	14.0								
	16.7	10:22	11:22	12:22	13:22	14:22	15:22	16:22	
 <p>MAPLE TESTON</p> 	18.3	10:18	11:18	12:18	13:18	14:18	15:18	16:18	
	18.5								
 <p>KING CITY AURORA</p> 	22.7	10:11	11:11	12:11	13:12	14:12	15:12	16:12	
	29.9	10:00	11:00	12:00	13:01	14:01	15:01	16:01	
 <p>NEWMARKET EAST GWILLIMBURY</p> 	34.2	09:52	10:52	11:52					
	35.5	09:48	10:48	11:48					
 <p>BRADFORD BRADFORD LAYOVER</p> 	41.5	09:39	10:39	11:39					
	51.9								
 <p>LEFROY BARRIE SOUTH</p> 	59.5	09:18	10:18	11:18					
	63.0	09:10	10:10	11:10					
 <p>ALLANDALE WATERFRONT LAYOVER YARD</p> 	62.5	(08:55)	(09:55)	(10:55)					
		800	802	804	806	808	810	812	
		CYCLE FROM	AE	AE	AE	801	803	805	807
Bus Connections		      							





Barrie Corridor		SOUTHWARD					
		WEEKEND SERVICE					
WESTON SUBDIVISION	CYCLE TO	815	817	819	821	823	WB
	SIZE	L12	L12	L12	L12	L12	L12
	Mile	814	816	818	820	822	824
♿ TORONTO JOHN ST BATHURST ST STRACHAN <small>Jct with CPR</small> PARKDALE <small>Jct with Newmarket Sub</small> ♿	0.0	17:55	19:03	20:03	21:03	22:03	23:03
	0.5	(17:50)	(18:58)	(19:58)	(20:58)	(21:58)	(22:58)
	1.1	↑	↑	↑	↑	↑	↑
	1.5						
	1.9						
	3.0						
NEWMARKET SUBDIVISION							
PARKDALE <small>Jct with Weston Sub</small> DAVENPORT FAIRBANK ♿ DOWNSVIEW PARK SNIDER SOUTH ♿ YORK UNIVERSITY SNIDER SNIDER NORTH ♿ RUTHERFORD ♿ MAPLE TESTON ♿ KING CITY ♿ AURORA ♿ NEWMARKET ♿ EAST GWILLIMBURY ♿ BRADFORD BRADFORD LAYOVER LEFROY ♿ BARRIE SOUTH ♿ ALLANDALE WATERFRONT LAYOVER YARD ♿	3.0						
	4.6	(17:41)	(18:49)	(19:49)	(20:49)	(21:49)	(22:49)
	6.4						
	10.8	17:33	18:41	19:41	20:41	21:41	22:41
	12.1	↑	↑	↑	↑	↑	↑
	12.6						
	12.9						
	14.0						
	16.7	17:22	18:32	19:32	20:32	21:32	22:32
	18.3	17:18	18:28	19:28	20:28	21:28	22:28
	18.5						
	22.7	17:12	18:22	19:22	20:22	21:22	22:22
	29.9	17:01	18:11	19:11	20:11	21:11	22:11
	34.2						
	35.5						
	41.5						
51.9							
59.5							
63.0							
62.5							
		814	816	818	820	822	824
	CYCLE FROM	809	E816	813	815	817	819
Bus Connections							















Barrie Corridor		NORTHWARD								
		WEEKEND SERVICE								
WESTON SUBDIVISION	CYCLE FROM	800	802	804	806	808	WB	BNY	812	
	SIZE	L12	L12	L12	L12	L12	L12	L12	L12	
	Mile	801	803	805	807	809	811	E816	813	
♿ TORONTO JOHN ST BATHURST ST STRACHAN <small>Jct with CPR</small> PARKDALE <small>Jct with Newmarket Sub</small> ♿	0.0	12:00	13:00	14:00	15:00	16:00	17:00	(17:12)	18:10	
	0.5	(12:05)	(13:05)	(14:05)	(15:05)	(16:05)	(17:05)	(17:17)	(18:15)	
	1.1	↓	↓	↓	↓	↓	↓	↓	↓	
	1.5	↓	↓	↓	↓	↓	↓	↓	↓	
	1.9	↓	↓	↓	↓	↓	↓	↓	↓	
	3.0	↓	↓	↓	↓	↓	↓	↓	↓	
	NEWMARKET SUBDIVISION									
		3.0	↓	↓	↓	↓	↓	↓	↓	↓
		4.6	(12:11)	(13:11)	(14:11)	(15:11)	(16:11)	(17:11)	(17:23)	(18:21)
		6.4								
♿ DOWNSVIEW PARK SNIDER SOUTH YORK UNIVERSITY SNIDER SNIDER NORTH RUTHERFORD MAPLE TESTON KING CITY AURORA NEWMARKET EAST GWILLIMBURY BRADFORD BRADFORD LAYOVER LEFROY BARRIE SOUTH ALLANDALE WATERFRONT LAYOVER YARD ♿	10.8	12:18	13:18	14:18	15:18	16:18	17:18	(17:30)	18:28	
	12.1	↓	↓	↓	↓	↓	↓	↓	↓	
	12.6	↓	↓	↓	↓	↓	↓	↓	↓	
	12.9	↓	↓	↓	↓	↓	↓	↓	↓	
	14.0	↓	↓	↓	↓	↓	↓	↓	↓	
	16.7	12:28	13:28	14:28	15:28	16:28	17:28	(17:40)	18:38	
	18.3	12:33	13:33	14:33	15:33	16:33	17:33	(17:45)	18:43	
	18.5									
	22.7	12:40	13:40	14:40	15:40	16:40	17:41	(17:53)	18:50	
	29.9	12:51	13:51	14:51	15:51	16:51	17:51	(18:03)	19:01	
	34.2						17:58			
	35.5						18:02			
	41.5						18:10			
	51.9									
	59.5						18:30			
	63.0						18:40			
	62.5						(18:55)			
		801	803	805	807	809	811	E816	813	
	CYCLE TO	806	808	810	812	814	AE	816	818	
Bus Connections										





Barrie Corridor		NORTHWARD				
WESTON		WEEKEND SERVICE				
SUBDIVISION	CYCLE FROM	814	816	818	820	822
	SIZE	L12	L12	L12	L12	L12
	Mile	815	817	819	821	823
♿ TORONTO	0.0	19:10	20:10	21:10	22:10	23:10
JOHN ST	0.5	(19:15)	(20:15)	(21:15)	(22:15)	(23:15)
BATHURST ST	1.1	↓	↓	↓	↓	↓
STRACHAN	1.5	↓	↓	↓	↓	↓
Jct with CPR	1.9	↓	↓	↓	↓	↓
PARKDALE	3.0	↓	↓	↓	↓	↓
Jct with Newmarket Sub						
NEWMARKET						
SUBDIVISION						
	3.0	↓	↓	↓	↓	↓
PARKDALE						
Jct with Weston Sub						
DAVENPORT	4.6	(19:21)	(20:21)	(21:21)	(22:21)	(23:21)
FAIRBANK	6.4					
♿ DOWNSVIEW PARK	10.8	19:28	20:28	21:28	22:28	23:28
♿ SNIDER SOUTH	12.1	↓	↓	↓	↓	↓
♿ YORK UNIVERSITY	12.6	↓	↓	↓	↓	↓
SNIDER	12.9	↓	↓	↓	↓	↓
SNIDER NORTH	14.0	↓	↓	↓	↓	↓
♿ RUTHERFORD	16.7	19:38	20:38	21:38	22:38	23:38
♿ MAPLE	18.3	19:43	20:43	21:43	22:43	23:43
TESTON	18.5					
♿ KING CITY	22.7	19:50	20:50	21:50	22:51	23:51
♿ AURORA	29.9	20:01	21:01	22:01	23:01	00:01
♿ NEWMARKET	34.2				23:08	00:08
♿ EAST GWILLIMBURY	35.5				23:12	00:12
♿ BRADFORD	41.5				23:20	00:20
BRADFORD LAYOVER						
LEFROY	51.9					
♿ BARRIE SOUTH	59.5				23:40	00:40
♿ ALLANDALE WATERFRONT	63.0				23:50	00:50
LAYOVER YARD	62.5				(00:05)	(01:05)
		815	817	819	821	823
CYCLE TO		820	822	824	AE	AE
Bus Connections						

















WESTWARD		KITCHENER - WEEKDAY									
CYCLE FROM		SH	WB	WB	SH	861	780	Cherry St.	873	796	875
STATIONS	Mile	E204	E260	E250	E212	E268	E258	269	781	271	783
WESTON SUBDIVISION											
TORONTO	0.0		(04:45)	(04:55)		(06:33)	(06:43)	08:55	9:40	09:48	10:40
JOHN ST.	0.5							
BATHURST ST	1.1		↓	↓		↓	↓	↓	↓	↓	↓
STRACHAN AVE	1.5										
Jct with CPR	1.9										
PARKDALE	3.0							↓	To Newmkt Sub	↓	To Newmkt Sub
Jct with Newmarket Sub											
BLOOR	4.0							09:04		09:57	
NICKLE	7.3										
WESTON	8.6							09:12		10:05	
HUMBERVIEW	10.0										
ETOBICOKE NORTH	11.0							09:18		10:11	
WICE	13.4										
MALTON	14.7					(07:01)	(07:03)	09:24		10:17	
AIRWAY	15.7										
HALWEST	16.8										
Jct with Halton Sub											
HALTON SUBDIVISION											
HALWEST	11.1			↓		(07:07)		↓		↓	
Jct with Weston Sub											
BRAMALEA	11.6			(05:44)		(07:08)		09:30		10:23	
PEEL	14.8										
BRAMPTON	15.4							09:38		10:31	
MOUNT PLEASANT	18.2		(05:46)			(07:23)		09:44		10:37	
CREDIT	22.5										
GEORGETOWN	23.5										
GEXR GUELPH SUBDIVISION											
SILVER	30.0										
ACTON	35.6										
GUELPH	48.8										
SHIRLEY LAYOVER	60.6	(04:44)			(06:05)						
KITCHENER	62.7	(05:19)			(06:42)						
KITCHENER LAYOVER	63.2										
		E204	E260	E250	E212	E268	E258	269	781	271	783
CYCLE TO		204	260	250	212	268	258	270	800	272	802
Bus Connections											









WESTWARD		KITCHENER - WEEKDAY									
CYCLE FROM		798	877	800	881	802	883	MY	806	569	WB
STATIONS	Mile	273	785	275	787	277	789	279	791	281	203
WESTON SUBDIVISION											
TORONTO	0.0	10:53	11:40	11:53	12:40	12:53	13:40	13:53	14:40	14:53	15:35
JOHN ST.	0.5	↓	↓	↓	↓
BATHURST ST	1.1	↓	↓	↓	↓	↓	↓	↓	↓	↓	↓
STRACHAN AVE	1.5	↓	↓	↓	↓	↓	↓	↓	↓	↓	↓
Jct with CPR	1.9	↓	↓	↓	↓	↓	↓	↓	↓	↓	↓
PARKDALE	3.0	↓	To Newmkt Sub	↓	To Newmkt Sub	↓	To Newmkt Sub	↓	To Newmkt Sub	↓	↓
Jct with Newmarket Sub											
BLOOR	4.0	11:02		12:02		13:02		14:02		15:02	15:45
NICKLE	7.3										
WESTON	8.6	11:10		12:10		13:10		14:10		15:10	15:54
HUMBERVIEW	10.0										
ETOBICOKE NORTH	11.0	11:16		12:16		13:16		14:16		15:16	16:01
WICE	13.4										
MALTON	14.7	11:22		12:22		13:22		14:22		15:22	16:08
AIRWAY	15.7										
HALWEST	16.8	↓		↓		↓		↓		↓	↓
Jct with Halton Sub											
HALTON SUBDIVISION											
HALWEST	11.1	↓		↓		↓		↓		↓	↓
Jct with Weston Sub											
BRAMALEA	11.6	11:28		12:28		13:28		14:28		15:28	16:16
PEEL	14.8										
BRAMPTON	15.4	11:36		12:36		13:36		14:36		15:36	16:24
MOUNT PLEASANT	18.2	11:42		12:42		13:42		14:42		15:42	16:30
CREDIT	22.5										
GEORGETOWN	23.5										16:42
GEXR GUELPH SUBDIVISION											
SILVER	30.0										
ACTON	35.6										
GUELPH	48.8										
SHIRLEY LAYOVER	60.6										
KITCHENER	62.7										
KITCHENER LAYOVER	63.2										
		273	785	275	787	277	789	279	791	281	203
CYCLE TO		274	804	276	806	278	808	280	BR	282	GE
Bus Connections											

WESTWARD		KITCHENER - WEEKDAY									
CYCLE FROM		WB	280	BNY	DY	889	E285	WB	DY	WB	WB
STATIONS	Mile	793	205	795	797	207	285	799	209	211	801
WESTON SUBDIVISION											
TORONTO	0.0	15:40	16:20	16:10	16:40	16:50	17:02	17:05	17:20	17:50	17:35
JOHN ST.	0.5		
BATHURST ST	1.1	↓	↓	↓	↓		↓	↓	↓	↓	↓
STRACHAN AVE	1.5										
Jct with CPR	1.9										
PARKDALE	3.0	To Newmkt Sub	↓	To Newmkt Sub	To Newmkt Sub		↓	To Newmkt Sub	↓	↓	To Newmkt Sub
Jct with Newmarket Sub											
BLOOR	4.0		16:30				17:12		17:30	18:00	
NICKLE	7.3										
WESTON	8.6		16:39				17:21		17:39	18:09	
HUMBERVIEW	10.0										
ETOBICOKE NORTH	11.0		16:46				17:28		17:46	18:16	
WICE	13.4										
MALTON	14.7		16:53				17:35		17:53	18:23	
AIRWAY	15.7										
HALWEST	16.8		↓				↓		↓	↓	
Jct with Halton Sub											
HALTON SUBDIVISION											
HALWEST	11.1		↓			↓	↓		↓	↓	
Jct with Weston Sub											
BRAMALEA	11.6		17:01			17:19	17:43		18:01	18:31	
PEEL	14.8										
BRAMPTON	15.4		17:10			17:28	17:52		18:10	18:40	
MOUNT PLEASANT	18.2		17:16			17:34	17:58		18:16	18:46	
CREDIT	22.5										
GEORGETOWN	23.5		17:28			17:44			18:28	18:56	
GEXR GUELPH SUBDIVISION											
SILVER	30.0					(17:47)			(18:32)	(18:59)	
ACTON	35.6					17:58			18:43	19:10	
GUELPH	48.8					18:13			18:58	19:28	
SHIRLEY LAYOVER	60.6										
KITCHENER	62.7					18:45			19:32	19:57	
KITCHENER LAYOVER	63.2					(19:15)			(19:52)		
		793	205	795	797	207	285	799	209	211	801
CYCLE TO		AE	GE	AE	AE	KW	E892	AE	KW	SH	AE
Bus Connections											





WESTWARD			KITCHENER - WEEKDAY						
CYCLE FROM		SCOTT	WB	WB	WB	BNY	E811	BNY	810
STATIONS	Mile	803	289	805	807	809	811	813	815
WESTON SUBDIVISION									
TORONTO  	0.0	18:05	18:50	18:35	19:05	19:40	19:05	20:40	22:40
JOHN ST.	0.5							
BATHURST ST	1.1	↓	↓	↓	↓	↓	↓	↓	↓
STRACHAN AVE	1.5								
Jct with CPR	1.9	To	↓	To	To	To	To	To	To
PARKDALE	3.0	Newmkt Sub		Newmkt Sub	Newmkt Sub	Newmkt Sub	Newmkt Sub	Newmkt Sub	Newmkt Sub
Jct with Newmarket Sub									
BLOOR	4.0		19:00						
NICKLE	7.3								
WESTON 	8.6		19:09						
HUMBERVIEW	10.0								
ETOBICOKE NORTH 	11.0		19:16						
WICE	13.4								
MALTON 	14.7		19:23						
AIRWAY	15.7								
HALWEST	16.8								
Jct with Halton Sub			↓						
HALTON SUBDIVISION									
HALWEST	11.1								
Jct with Weston Sub									
BRAMALEA  	11.6		19:31						
PEEL	14.8								
BRAMPTON 	15.4		19:40						
MOUNT PLEASANT 	18.2		19:46						
CREDIT	22.5								
GEORGETOWN 	23.5		19:56						
GEXR GUELPH SUBDIVISION									
SILVER	30.0		(19:59)						
ACTON 	35.6		20:10						
GUELPH 	48.8		20:25						
SHIRLEY LAYOVER	60.6		(21:27)						
KITCHENER 	62.7		20:57						
KITCHENER LAYOVER	63.2								
		803	289	805	807	809	811	813	815
CYCLE TO		AE	SH	AE	BR	810	812	814	BR
Bus Connections									





EASTWARD		KITCHENER - WEEKDAY									
CYCLE TO		550	E258	552	554	WB	556	WB	WB	MY	WB
STATIONS	Mile	250	780	260	782	204	784	786	206	208	788
WESTON SUBDIVISION											
TORONTO	0.0	06:32	06:33	06:50	07:03	07:27	07:33	07:47	07:52	07:55	08:03
JOHN ST.	0.5	(06:27)		(06:48)		(07:22)			(07:47)	(07:51)	
BATHURST ST	1.1		↑		↑		↑	↑		↑	↑
STRACHAN AVE	1.5	↑		↑					↑		
Jct with CPR	1.9		From Newmkt Sub		From Newmkt Sub		From Newmkt Sub	From Newmkt Sub			From Newmkt Sub
PARKDALE	3.0										
Jct with Newmarket Sub											
BLOOR	4.0	06:20		06:38		07:15			07:40		
		↑		↑		↑			↑		
NICKLE	7.3										
WESTON	8.6	06:12		06:30		07:07			07:32		
HUMBERVIEW	10.0										
ETOBICOKE NORTH	11.0	06:06		06:24		07:01			07:26		
WICE	13.4										
MALTON	14.7	06:00		06:18		06:55			07:20		
AIRWAY	15.7										
HALWEST	16.8										
Jct with Halton Sub		↑		↑					↑		
HALTON SUBDIVISION											
HALWEST	11.1										
Jct with Weston Sub											
BRAMALEA	11.6	05:54		06:12		06:49			07:14	07:29	
PEEL	14.8										
BRAMPTON	15.4			06:03		06:39			07:04	07:19	
MOUNT PLEASANT	18.2			05:55		06:32			06:57	07:12	
CREDIT	22.5										
GEORGETOWN	23.5					06:23			06:48	07:03	
GEXR GUELPH SUBDIVISION											
SILVER	30.0					(06:16)				(06:56)	
ACTON	35.6					06:05				06:45	
GUELPH	48.8					05:48				06:28	
SHIRLEY LAYOVER	60.6										
KITCHENER	62.7					05:24				06:04	
KITCHENER LAYOVER	63.2									(05:34)	
		250	780	260	782	204	784	786	206	208	788
CYCLE FROM		E250	BR	E260	AE	SH	AE	AE	GE	KW	AE
Bus Connections											

EASTWARD		KITCHENER - WEEKDAY									
CYCLE TO		DY	WB	WB	499	500	WB	WB	271	880	273
STATIONS	Mile	210	790	792	212	794	258	214	796	268	798
WESTON SUBDIVISION											
TORONTO  	0.0	08:20	08:19	08:33	08:50	09:03	09:05	09:13	09:33	09:53	10:33
JOHN ST.	0.5	(08:15)			(08:45)	↑	(09:00)	(09:08)	↑	(09:48)	↑
BATHURST ST	1.1		↑	↑							
STRACHAN AVE	1.5	↑			↑		↑	↑		↑	
Jct with CPR	1.9										
PARKDALE	3.0		From Newmkt Sub	From Newmkt Sub		From Newmkt Sub			From Newmkt Sub		From Newmkt Sub
Jct with Newmarket Sub											
BLOOR	4.0	08:08			08:38		08:53	09:01		09:42	
		↑			↑		↑	↑		↑	
NICKLE	7.3										
WESTON 	8.6	08:00			08:30		08:45	08:53		09:34	
HUMBERVIEW	10.0										
ETOBICOKE NORTH 	11.0	07:54			08:24		08:39	08:47		09:28	
WICE	13.4										
MALTON 	14.7	07:48			08:18		08:33	08:41		09:22	
AIRWAY	15.7										
HALWEST	16.8										
Jct with Halton Sub		↑									
HALTON SUBDIVISION											
HALWEST	11.1										
Jct with Weston Sub											
BRAMALEA  	11.6	07:42			08:12			08:35		09:16	
PEEL	14.8										
BRAMPTON 	15.4	07:32			08:02			08:25		09:09	
MOUNT PLEASANT 	18.2	07:25			07:55			08:18		09:00	
CREDIT	22.5										
GEORGETOWN 	23.5	07:16			07:46			08:09			
GEXR GUELPH SUBDIVISION											
SILVER	30.0										
ACTON 	35.6				07:28			(08:02)			
GUELPH 	48.8				07:11			07:34			
SHIRLEY LAYOVER	60.6										
KITCHENER 	62.7				06:47			07:10			
KITCHENER LAYOVER	63.2							(06:50)			
		210	790	792	212	794	258	214	796	268	798
CYCLE FROM		GE	AE	AE	SH	AE	E258	KW	BR	E268	BR
Bus Connections											

EASTWARD		KITCHENER - WEEKDAY									
CYCLE TO		882	275	884	277	886	279	MY	791	860	WB
STATIONS	Mile	270	800	272	802	274	804	276	806	278	808
WESTON SUBDIVISION											
TORONTO	0.0	10:49	11:33	12:00	12:33	12:54	13:33	13:54	14:33	14:54	15:33
JOHN ST.	0.5	(10:44)	↑	(11:49)	↑	(12:49)	↑	(13:49)	↑	(14:49)	↑
BATHURST ST	1.1		↑		↑		↑		↑		↑
STRACHAN AVE	1.5	↑		↑		↑		↑		↑	
Jct with CPR	1.9		From Newmkt Sub		From Newmkt Sub		From Newmkt Sub		From Newmkt Sub		From Newmkt Sub
PARKDALE	3.0										
Jct with Newmarket Sub											
BLOOR	4.0	10:37		11:42		12:42		13:42		14:42	
		↑		↑		↑		↑		↑	
NICKLE	7.3										
WESTON	8.6	10:29		11:34		12:34		13:34		14:34	
HUMBERVIEW	10.0										
ETOBICOKE NORTH	11.0	10:23		11:28		12:28		13:28		14:28	
WICE	13.4										
MALTON	14.7	10:17		11:22		12:22		13:22		14:22	
AIRWAY	15.7	↑		↑		↑		↑		↑	
HALWEST	16.8										
Jct with Halton Sub											
HALTON SUBDIVISION											
HALWEST	11.1										
Jct with Weston Sub											
BRAMALEA	11.6	10:11		11:16		12:16		13:16		14:16	
PEEL	14.8										
BRAMPTON	15.4	10:04		11:09		12:09		13:09		14:09	
MOUNT PLEASANT	18.2	09:55		11:00		12:00		13:00		14:00	
CREDIT	22.5										
GEORGETOWN	23.5										
GEXR GUELPH SUBDIVISION											
SILVER	30.0										
ACTON	35.6										
GUELPH	48.8										
SHIRLEY LAYOVER	60.6										
KITCHENER	62.7										
KITCHENER LAYOVER	63.2										
		270	800	272	802	274	804	276	806	278	808
CYCLE FROM		269	781	271	783	273	785	275	787	277	789
Bus Connections											

EASTWARD		KITCHENER - WEEKDAY							
CYCLE TO		205	864	892	SH	SH	DY	WB	WB
STATIONS	Mile	280	282	E892	E211	E289	810	812	814
WESTON SUBDIVISION									
TORONTO	0.0	15:54	16:39	(19:15)			21:33	22:33	23:33
JOHN ST.	0.5	(15:49)	(16:34)				↑	↑	↑
BATHURST ST	1.1	↑	↑	↑					
STRACHAN AVE	1.5	↑	↑	↑					
Jct with CPR	1.9								
PARKDALE	3.0						From Newmkt Sub	From Newmkt Sub	From Newmkt Sub
Jct with Newmarket Sub									
BLOOR	4.0								
NICKLE	7.3								
WESTON	8.6								
HUMBERVIEW	10.0								
ETOBICOKE NORTH	11.0								
WICE	13.4			(18:32)					
MALTON	14.7	15:22	16:14						
AIRWAY	15.7	↑	↑	↑					
HALWEST	16.8	↑	↑	↑					
Jct with Halton Sub									
HALTON SUBDIVISION									
HALWEST	11.1								
Jct with Weston Sub									
BRAMALEA	11.6	15:16	16:09						
PEEL	14.8								
BRAMPTON	15.4	15:09	16:01						
MOUNT PLEASANT	18.2	15:00	15:52	(18:10)					
CREDIT	22.5								
GEORGETOWN	23.5								
GEXR GUELPH SUBDIVISION									
SILVER	30.0								
ACTON	35.6								
GUELPH	48.8								
SHIRLEY LAYOVER	60.6				(20:27)	(21:27)			
KITCHENER	62.7				(20:02)	(21:02)			
KITCHENER LAYOVER	63.2								
		280	282	E892	E211	E289	810	812	814
CYCLE FROM		279	281	285	211	289	809	811	813
Bus Connections									

EASTWARD			MILTON - WEEKDAY									
CYCLE TO			DON	E474	DON	DON	DON	DON	WR	WB	WB	502
STATIONS	Mile		148	150	152	154	156	158	160	162	164	166
TORONTO	0.0	U	07:00	07:24	07:45	08:02	08:15	08:27	08:38	08:48	09:00	09:30
JOHN ST.	0.5	S	(06:55)	(07:19)	(07:40)	(07:57)	(08:10)	(08:22)	(08:33)	(08:43)	(08:55)	(09:25)
BATHURST ST	1.1	R	↑	↑	↑	↑	↑	↑	↑	↑	↑	↑
STRACHAN AVE.	1.9	C	↑	↑	↑	↑	↑	↑	↑	↑	↑	↑
PARKDALE	3.0											
DUNDAS	3.5											
DUPONT	4.3											
WEST TORONTO	4.9											
LAMBTON	5.8											
SCARLETT RD	6.8											
HUMBER	7.3											
ROYAL YORK	7.5											
BLOOR	8.9											
OBICO	9.6											
KIPLING	9.7	C	06:40	07:04	07:25	07:42	07:55	08:07	08:18	08:28	08:40	09:07
DIXIE	12.4	C	06:34	06:58	07:19	07:36	07:49	08:01	08:12	08:22	08:34	09:01
COOKSVILLE	15.4		06:28	06:52	07:13	07:30	07:43	07:55	08:06	08:16	08:28	08:55
ERINDALE	18.1		06:23	06:47	07:08	07:25	07:38	07:50	08:01	08:11	08:23	08:50
STREETSVILLE	20.3		06:18	06:42	07:03	07:20	07:33	07:45	07:56	08:06	08:18	08:45
STREETSVILLE JCT	21.2											
Jct with Orangeville Sub												
MEADOWVALE	23.1		06:11	06:35	06:56	07:13	07:26	07:38	07:49	07:59	08:11	08:38
LISGAR	25.2		06:07	06:31	06:52	07:09	07:22	07:34	07:45	07:55	08:07	08:34
HORNBY	27.5											
MILTON	31.2		05:59	06:23	06:44	07:01	07:14	07:26	07:37	07:47	07:59	08:26
CYCLE FROM			E148	E150	E152	E154	E156	E158	E160	E162	E164	E166
STATIONS	Mile		E148	E150	E152	E154	E156	E158	E160	E162	E164	E166
MILTON	31.2		05:46	06:13	06:31	06:48	07:01	07:13	07:24	07:34	07:46	08:13
MILTON STUB TRACK	31.7											
MILTON YARD	30.5		(05:36)	(06:03)	(06:21)	(06:38)	(06:51)	(07:03)	(07:14)	(07:24)	(07:36)	(08:03)
CYCLE FROM			STORAGE									
Bus Connections												

WESTWARD			MILTON - WEEKDAY								
CYCLE FROM		WB	BY	BNY	DON	DON	DON	E161	WB	WB	WB
STATIONS	Mile	149	151	153	155	157	159	161	163	165	167
TORONTO	0.0	15:40	16:10	16:40	16:55	17:10	17:25	17:40	17:55	18:25	19:10
JOHN ST.	0.5
BATHURST ST	1.1	↓	↓	↓	↓	↓	↓	↓	↓	↓	↓
STRACHAN	1.5	↓	↓	↓	↓	↓	↓	↓	↓	↓	↓
PARKDALE	3.0	↓	↓	↓	↓	↓	↓	↓	↓	↓	↓
DUNDAS	3.5	↓	↓	↓	↓	↓	↓	↓	↓	↓	↓
DUPONT	4.3	↓	↓	↓	↓	↓	↓	↓	↓	↓	↓
LAMBTON	5.8	↓	↓	↓	↓	↓	↓	↓	↓	↓	↓
SCARLETT RD	6.8	↓	↓	↓	↓	↓	↓	↓	↓	↓	↓
HUMBER	7.3	↓	↓	↓	↓	↓	↓	↓	↓	↓	↓
ROYAL YORK	7.5	↓	↓	↓	↓	↓	↓	↓	↓	↓	↓
BLOOR	8.9	↓	↓	↓	↓	↓	↓	↓	↓	↓	↓
OBICO	9.6	↓	↓	↓	↓	↓	↓	↓	↓	↓	↓
KIPLING	9.7	15:56	16:26	16:56	17:11	17:26	17:41	17:56	18:11	18:41	19:26
DIXIE	12.4	16:02	16:32	17:02	17:17	17:32	17:47	18:02	18:17	18:47	19:32
COOKSVILLE	15.4	16:08	16:38	17:08	17:23	17:38	17:53	18:08	18:23	18:53	19:38
ERINDALE	18.1	16:14	16:44	17:14	17:29	17:44	17:59	18:14	18:29	18:59	19:44
STREETSVILLE	20.3	16:19	16:49	17:19	17:34	17:49	18:04	18:19	18:34	19:04	19:49
STREETSVILLE JCT Jct with Orangeville Sub	21.2										
MEADOWVALE	23.1	16:25	16:55	17:25	17:40	17:55	18:10	18:25	18:40	19:10	19:55
LISGAR	25.2	16:29	16:59	17:29	17:44	17:59	18:14	18:29	18:44	19:14	19:59
HORNBY	27.5										
MILTON	31.2	16:39	17:09	17:39	17:54	18:09	18:24	18:39	18:54	19:24	20:09
CYCLE TO		E149M*	E151M	E153M	E155M	E157M	E159M	E161M	E163M	E165M	E167M
STATIONS	Mile	E149M	E151M	E153M	E155M	E157M	E159M	E161M	E163M	E165M	E167M
MILTON	31.2	16:44	17:14	17:44	17:59	18:14	18:29	18:44	18:59	19:29	20:14
MILTON STUB TRACK	31.7										
MILTON YARD	30.5	(17:01)	(17:31)	(18:01)	(18:16)	(18:31)	(18:46)	(19:01)	(19:16)	(19:46)	(20:31)
CYCLE TO		STORAGE									
Bus Connections											

WESTWARD		STOUFFVILLE - WEEKDAY																	
BUS CONNECTIONS																			
CYCLE FROM		STORAGE										880	882	884	886	858	890	892	894
STATIONS	Mile	861	863	865	867	869	871	873	875	877	881	883	885	887	889	891	893	895	
UXBRIDGE SUBDIVISION																			
LINCOLNVILLE	38.8	05:15	05:54	06:24	06:41	07:13	07:41	08:11	09:17	10:14									
STOUFFVILLE	40.6	05:22	06:01	06:31	06:48	07:20	07:48	08:18	09:24	10:21									
MOUNT JOY	45.7	05:32	06:11	06:41	06:58	07:30	07:58	08:28	09:34	10:31									
MARKHAM	47.0	05:37	06:16	06:46	07:03	07:35	08:03	08:33	09:39	10:36									
CENTENNIAL	48.5	05:42	06:21	06:51	07:08	07:40	08:08	08:38	09:44	10:41									
UNIONVILLE	50.7	05:47	06:27	06:57	07:14	07:46	08:14	08:44	09:49	10:46	11:46	12:46	13:46	14:46	15:46	21:01	22:11	23:01	
HAGERMAN	51.1	
UNDERWOOD	52.1	
MILLIKEN	52.9	05:55	06:35	07:05	07:22	07:54	08:22	08:52	09:57	10:54	11:54	12:54	13:54	14:54	15:54	21:09	22:19	23:09	
AGINCOURT	55.5	06:02	06:42	07:12	07:29	08:01	08:29	08:59	10:04	11:01	12:01	13:01	14:01	15:01	16:01	21:16	22:26	23:16	
KENNEDY	59.5	06:09	06:49	07:19	07:36	08:08	08:36	09:06	10:11	11:08	12:08	13:08	14:08	15:08	16:08	21:23	22:33	23:23	
SCARBOROUGH	61.0	(06:11)	(06:51)	(07:21)	(07:38)	(08:10)	(08:38)	(09:08)	(10:13)	(11:10)	(12:10)	(13:10)	(14:10)	(15:10)	(16:10)	(21:25)	(22:35)	(23:25)	
KINGSTON SUBDIVISION																			
SCARBOROUGH	325.2	↓	↓	↓	↓	↓	↓	↓	↓	↓	↓	↓	↓	↓	↓	↓	↓	↓	
DANFORTH	328.6	06:15	↓	07:28	07:48	08:20	08:48	09:18	10:23	↓	↓	↓	↓	↓	↓	↓	↓	↓	
CHERRY STREET	332.6	↓	↓	↓	↓	↓	↓	↓	↓	↓	↓	↓	↓	↓	↓	↓	↓	↓	
SCOTT ST	333.3	(06:24)	(07:04)	(07:36)	(07:53)	(08:25)	(08:56)	(09:26)	(10:31)	(11:23)	(12:23)	(13:23)	(14:23)	(15:23)	(16:23)	(21:41)	(22:48)	(23:38)	
TORONTO	333.8	06:28	07:08	07:40	08:00	08:32	09:00	09:30	10:35	11:27	12:27	13:27	14:27	15:27	16:27	21:45	22:52	23:42	
CYCLE TO		E268	E122	BNY	607	BNY	MY	781	783	785	787	789	BNY	DY	207	896	WB	WB	

EASTWARD		STOUFFVILLE - WEEKDAY																
BUS CONNECTIONS																		
CYCLE TO		881	883	885	887	889	STORAGE								891	893	895	STORE
STATIONS	Mile	880	882	884	886	888	860	862	864	866	868	870	872	874	890	892	894	896
UXBRIDGE SUBDIVISION																		
LINCOLNVILLE	38.8						16:24	17:38	18:08	18:37	19:02	19:30	19:48	20:31				23:43
STOUFFVILLE	40.6						16:13	17:27	17:57	18:26	18:51	19:19	19:37	20:20				23:32
MOUNT JOY	45.7						16:04	17:18	17:48	18:17	18:42	19:10	19:28	20:11				23:23
MARKHAM	47.0						16:00	17:14	17:44	18:13	18:38	19:06	19:24	20:07				23:19
CENTENNIAL	48.5						15:55	17:09	17:39	18:08	18:33	19:01	19:19	20:02				23:14
UNIONVILLE	50.7	10:54	11:54	12:54	13:54	14:54	15:50	17:03	17:33	18:02	18:27	18:55	19:13	19:56	20:39	21:09	22:19	23:09
HAGERMAN	51.1
UNDERWOOD	52.1
MILLIKEN	52.9	10:47	11:47	12:47	13:47	14:47	15:43	16:56	17:26	17:55	18:20	18:48	19:06	19:49	20:32	21:02	22:12	23:02
AGINCOURT	55.5	10:40	11:40	12:40	13:40	14:40	15:36	16:48	17:18	17:47	18:12	18:40	18:59	19:42	20:25	20:55	22:05	22:55
KENNEDY	59.5	10:32	11:32	12:32	13:32	14:32	15:28	16:40	17:10	17:39	18:04	18:32	18:52	19:35	20:17	20:47	21:57	22:47
SCARBOROUGH	61.0	(10:28)	(11:28)	(12:28)	(13:28)	(14:28)	(15:24)	(16:36)	17:06	(17:35)	(18:00)	(18:28)	(18:48)	(19:31)	(20:13)	(20:43)	(21:53)	(22:43)
UXBRIDGE SUBDIVISION																		
SCARBOROUGH	325.2	↑	↑	↑	↑	↑	↑	↑	↑	↑	↑	↑	↑	↑	↑	↑	↑	↑
DANFORTH	328.6	↑	↑	↑	↑	↑	↑	16:29	16:59	↑	↑	18:21	↑	↑	↑	↑	↑	↑
CHERRY STREET	332.6	↑	↑	↑	↑	↑	↑	↑	↑	↑	↑	↑	↑	↑	↑	↑	↑	↑
SCOTT ST	333.3	↑	↑	↑	↑	↑	↑	↑	↑	↑	↑	↑	↑	↑	↑	↑	↑	↑
TORONTO	333.8	10:15	11:15	12:15	13:15	14:15	15:11	16:18	16:48	17:20	17:45	18:10	18:35	19:18	20:00	20:30	21:40	22:30
KINGSTON SUBDIVISION																		
CYCLE FROM		268	270	272	274	WB	278	WB	282	WB	WB	610	WB	MY	DY	E892	E894U	891

NORTHWARD		RICHMOND HILL - WEEKDAY											
CYCLE FROM		BNY	BNY	WB	481LE	BNY	WB	WB	831	833	835	837	839
STATIONS	Mile	829	831	833	835	837	839	841	E831R	E833R	E835R	E837R	E839R
USRC													
TORONTO	0.0	15:10	16:30	17:00	17:30	18:00	19:00	20:00					
SCOTT ST.	0.5					
BALA SUBDIVISION													
DON	2.0	↓	↓	↓	↓	↓	↓	↓					
ROSEDALE	3.6	(15:17)	(16:37)	(17:07)	(17:37)	(18:07)	(19:07)	(20:07)					
ORIOLE	12.2	15:35	16:55	17:25	17:55	18:25	19:25	20:24					
OLD CUMMER	14.1	15:39	16:59	17:29	18:00	18:30	19:29	20:28					
DONCASTER S.	15.4												
DONCASTER	16.1												
LANGSTAFF	18.3	15:47	17:07	17:37	18:08	18:38	19:36	20:36					
RICHMOND HILL	21.0	15:52	17:15	17:46	18:17	18:46	19:43	20:43					
ELGIN	22.7												
GORMLEY	26.2		17:25	17:56	18:27	18:56	19:53		(17:27)	(17:58)	(18:29)	(18:58)	(19:55)
RICHMOND HILL LAYOVER	27.3								(17:47)	(18:18)	(18:49)	(19:18)	(20:15)
BLOOMINGTON	28.8												
CYCLE TO		E285	E831R	E833R	E835R	E837R	E839R	E894U	RL	RL	RL	RL	RL

SOUTHWARD		RICHMOND HILL - WEEKDAY											
CYCLE TO		830	832	834	836	838	Cherry	WB	E834B	BNY	WB	285	894
STATIONS	Mile	E830	E832	E834	E836	E838	830	832	834	836	838	E285	E894U
TORONTO	0.0						07:11	07:41	08:13	08:43	09:13	(16:52)	(21:30)
SCOTT ST.	0.5						(07:05)	(07:35)	(08:07)	(08:37)	(09:07)		
USRC													
DON	2.0						↑	↑	↑	↑	↑		
ROSEDALE	3.6						(06:59)	(07:29)	(07:59)	(08:29)	(08:59)		
ORIOLE	12.2						06:44	07:14	07:44	08:14	08:44		
OLD CUMMER	14.1						06:39	07:09	07:39	08:09	08:39		
DONCASTER S.	15.4												
DONCASTER	16.1												
LANGSTAFF	18.3						06:31	07:01	07:31	08:01	08:31		
RICHMOND HILL	21.0						06:25	06:55	07:25	07:55	08:25	(16:07)	(20:53)
ELGIN	22.7												
GORMLEY	26.2	(06:05)	(06:35)	(07:05)	(07:35)	(08:05)	06:15	06:45	07:15	07:45	08:15		
RICHMOND HILL LAYOVER	27.3	(05:50)	(06:20)	(06:50)	(07:20)	(07:50)							
BLOOMINGTON	28.8												
BALA SUBDIVISION													
CYCLE FROM		RL	RL	RL	RL	RL	E830	E832	E834	E836	E838	E285	E894U

SOUTHWARD & WESTWARD		HAMILTON - WEEKDAY			
CYCLE TO		STORAGE			
STATIONS	Mile	475	477	483	485
LAYOVER YARD					
HAMILTON 	57.5	17:45	18:15	18:45	19:15
PARK	57.6	↑	↑	↑	↑
LOCKE	58.4				
MAIN	58.9				
DESJARDINS	60.1	(17:35)	(18:05)	(18:35)	(19:05)
Jct with CN Oakville Sub					
CYCLE FROM		Oakville Sub	Oakville Sub	Oakville Sub	Oakville Sub

NORTHWARD & EASTWARD		HAMILTON - WEEKDAY			
CYCLE FROM		STORAGE			
STATIONS	Mile	490	492	494	496
LAYOVER YARD					
HAMILTON 	57.5	05:48	06:18	06:48	07:18
PARK	57.6	↓	↓	↓	↓
LOCKE	58.4				
MAIN	58.9				
DESJARDINS	60.1	(05:54)	(06:24)	(06:54)	(07:24)
Jct with CN Oakville Sub					
CYCLE TO		Oakville Sub	Oakville Sub	Oakville Sub	Oakville Sub

Train standby radio channel = CP82
 RTC Call in channel = CP107
 Tower Code = *71#
 Emergency Call-in = 9117

**WORK PLAN METHODOLOGY TEMPLATE
CPG-PGM-FRM-277**

All Sections of the Work Plan Methodology Template (WPM) is to be filled by the Contractor except for Section 2. Project Delivery Team and/or Consultant to verify the contents of the form.

SECTION 1 - COVER PAGE

SECTION 1.1 - WORK OVERVIEW

Work Plan Name		Project Name	
Work Plan Number		Project Number	
Work Plan Revision No.		Contract Number	
Contractor		Subdivision	
WPM Author		Mileage Limits (Start and End)	
Metrolinx PDT Contact		Corridor	
Consultant / Technical Advisor		Competent Supervisor	
Major or Minor Work		Shifts (Day / Night / Continuous)	
Work Start	Date	Work End	Date
	Time (24hr)		Time (24hr)
Total Work Duration (Hours)		Total Number of Work Days / Nights	
Track Protection Requested		Track Work Block Requested	
Comments on Work Duration			

Dates are displayed in Day / Month / Year format and times are displayed in Military Time format (range 0000 to 2359). Disclaimer: Calculated total work duration and total number of work days/nights are estimates and are subject to Metrolinx's operational restrictions.

SECTION 1.2 - SUBMISSION STAGE GATE

Stage No.	Stage Description	Work plan Submission Deadline	Work plan Submission Date	Submission Deadline Met / Missed	Work Plan Revision No.	Status (Reviewed, Review with Comments, Revise and Resubmit, Scope Change)
1	WPM Submittal (40 Days in advance of Track Block)					
2	WPM Review Finalized (21 Days prior to Track Block)					
3	WPM Final Approval (7 Days prior to Track Block, decision subject to change)					
4	Pre-block Meeting (4 Days in Advance of the Track Block)					
5	Support Staff Conference (24 Hrs. in Advance of the Track Block)					

Pre-Block Meeting and Support Staff Conference to conform to specifications outlined in Track Closures, Railway Track Construction, Temporary Track Protection and other related documents. Dates are displayed in Day / Month / Year format

SECTION 1.3 – CORRIDOR ACCESS

Who is the Constructor for this work?	
Has Corridor Access been granted for this work?	
Are there other works to be coordinated with in the work area?	

SECTION 2 - STAKEHOLDER DISTRIBUTION AND REVIEW

SECTION 2.1 - REVIEW LOG

This section is to be completed by the Project Delivery Team. Please identify the status of the WPM Review.

Stage Description	Work Plan Revision No.	Submission Date	Name of Reviewer	Status (Reviewed, Review with Comments, Revise and Resubmit)
WPM Submittal				
WPM Received and distributed by Contract Administrator				
WPM Reviewed by Consultant				
WPM Reviewed by CPG				
WPM Reviewed by ICHST				
WPM Reviewed by RCI				
WPM Review Finalized				

SECTION 2.2: STAKEHOLDERS

This section is to be completed by the Project Delivery Team. Please check stakeholders that are impacted by the work outlined in this WPM. Add any missing stakeholders where required.

Metrolinx Internal Stakeholders

Capital Projects Group(CPG) Project Delivery Team	For INFO	For Review	RCI Track and Structures	For INFO	For Review
CPG Track and Structures	For INFO	For Review	RCI Signals & Communications	For INFO	For Review
Rail Services	For INFO	For Review	RCI Bridges and Structures	For INFO	For Review
Rail Operations	For INFO	For Review	Community Services	For INFO	For Review
Integrated Construction Health and Safety Team	For INFO	For Review	Transit Safety	For INFO	For Review
Network Infrastructure Electrification	For INFO	For Review	Station Operations	For INFO	For Review
Network Infrastructure Signals	For INFO	For Review	Customer Communications	For INFO	For Review
Service Planning	For INFO	For Review	Bus Operations	For INFO	For Review
StratComm	For INFO	For Review		For INFO	For Review
	For INFO	For Review		For INFO	For Review

External Stakeholders (Railways)

Canadian National Railway (CN)	For INFO	For Review	VIA Rail	For INFO	For Review
Canadian Pacific Railway (CP)	For INFO	For Review	Amtrak	For INFO	For Review
Goderich-Exeter Railway (GEXR)	For INFO	For Review		For INFO	For Review

External Stakeholders (Other Transit, Cities, Townships, Governments, Public Interest)

	For INFO	For Review		For INFO	For Review
	For INFO	For Review		For INFO	For Review
	For INFO	For Review		For INFO	For Review

Regulators

Ministry of Environment (MOE)	For INFO	For Review	Transport Canada	For INFO	For Review
Toronto and Region Conservation (TRCA)	For INFO	For Review		For INFO	For Review
	For INFO	For Review		For INFO	For Review

Public Services

Fire Department	For INFO	For Review	Schools	For INFO	For Review
Emergency Medical Services (EMS)	For INFO	For Review	Police Department	For INFO	For Review
	For INFO	For Review		For INFO	For Review

External Stakeholders (Utility Companies - Crossings or Parallel to track within WPM limits)

Hydro	For INFO	For Review	BELL	For INFO	For Review
TransCanada (Pipelines)	For INFO	For Review	COGECO	For INFO	For Review
Enbridge	For INFO	For Review	Rogers	For INFO	For Review
Water Lines	For INFO	For Review	Storm Sewer Lines	For INFO	For Review
Sanitation Sewer Lines	For INFO	For Review		For INFO	For Review
	For INFO	For Review		For INFO	For Review

SECTION 3: MAIN CONTENT**SECTION 3.1 - STAKEHOLDER CONSIDERATIONS**

Construction work on Metrolinx / GO Property can impact services, operations and the public. The Contractor shall ensure that their work will not impact operations or put public safety at risk. In relation to the tasks, all mitigating measures to eliminate or reduce operational and public impacts shall be described here. Risks to operations and public shall be identified in detail and evaluated in Section 6 Risk Assessment (RA) and Site Safety. The Contractor shall allocate enough time to clean up site after completion of work, to make site safe for operations and the public.

Service and Operational Impact**Surrounding Community Impact**

Describe any impact the work can impose on the community in the surrounding area (such as noise, dust, traffic control). Inform if special signage for the operation will be posted where and which kind, who will provide the signage, etc. Direct all communications with the public through Metrolinx PDT.

Roadway and Private Property Impact

Describe any traffic control, road closures and private property encroachments that are required for the work. List all permits required for the work and confirm if they have been obtained. A Traffic Plan shall be appended, and identified in Section 5 Attachments and Personnel List.

SECTION 3.2 - SCOPE OF WORK

Please provide a description of the work to be completed, including all objectives that are to be accomplished. Please include any multi-disciplinary involvement.

SECTION 3.3 - DETAILED TASK DESCRIPTION (Gantt Chart to be Appended)
Provide a detailed description of the work, including pre-work and post-work activities, in a chronological order to be performed.

Task No.	Activity/Task	Task Location and Detailed Task Description	Start Date	Start Time	Duration
1					
2					
3					
4					
5					
6					
7					
8					
9					
10					
11					
12					
13					
14					
15					

SECTION 3.6 - SCHEDULE RISK DESCRIPTION

List the milestone tasks to be completed before the next task can be started.

--

List the outside influences, including Weather and General Public constraints (ex. Road Closures, Public Events, etc.)

--

Can the work be stopped halfway through?

--

Can the block be extended without impacting operations?

--

If any of the above responses are Yes, please explain:

--

SECTION 3.7 - CONTINGENCY PLAN

Please identify and list additional resources that can be utilized if required

--

Please identify the amount of hours allocated to contingency:

--

Please provide the contingency plan for each milestone:

--

SECTION 3.8 - POINT OF NO RETURN DECISION (GO OR NO GO)

Recovery Plan to be appended with the WPM.

Critical Milestone	Meeting Location, Time and Date	Rail Operations Notified	Stakeholders Notified

Point of No Return	<i>Describe when the point of no return is reached in the schedule. Provide a date and time for the point of no return.</i>
How is the Decision Made	<i>Describe in detail exactly who makes the call and when it is to happen. Who from the contractor is allowed to make the call? Who from the stakeholders should be consulted?</i>
What Influences this Decision?	<i>Describe the influences that trigger the point of no return. (Examples: Weather, delay in pre-work, service disruption, funding, schedule, etc.)</i>

SECTION 3.9 - TRACK BLOCK

Identify Tracks Required for Track Block. Please see the accompanying document for the WPM which describes each block type.

Type of Track Block	Partial Block	Split Block	Total Block
Multi-Track	Single Track	Other Railroads?	
List the tracks required:		Location	
From Mileage		To Mileage	
Length of time required to complete work:			
Length of time available to complete the work:			
If time required is greater than time available, can the work be completed in stages?			

SECTION 3.10 - TRACK PROTECTION

Identify which company will provide flagging from the list below and Identify as Track Flagging and / or Signals Support

Track Protection	Track or Signals		Track Protection	Track or Signals	
A&B Rail	Track Flagging	Signals Support	GEXR	Track Flagging	Signals Support
TTR		Signals Support	CNR	Track Flagging	Signals Support
PNR	Track Flagging	Signals Support	CPR	Track Flagging	Signals Support
	Track Flagging	Signals Support		Track Flagging	Signals Support

When will the flagman be on site?		Is flagging continuous?	
When will the flagman leave site?			

SECTION 5.5 - EXTERNAL CONTACT LIST (add all required personnel)

Role	Name	Phone Number
Contract Administrator		
Contract Administrator		
Contract MTCE Provider Superintendent		
Contract MTCE Provider Track Supervisor		
Contract MTCE Provider Inspector		

SECTION 5.6 - METROLINX CONTACT LIST (add all required personnel)

Role	Name	Phone Number
Metrolinx Project Manager(CPG)		
Metrolinx Project Coordinator(CPG)		
RCI Track Specialist		
RCI Signal Specialist		
RCI Bridges & Structures Specialist		

SECTION 5.7 - EMERGENCY CONTACT LIST

Role	Name	Phone Number
Nearest Hospital		
Emergency Services		911
GO CMO Emergency		416-601-3611
GO Transit Control Centre(GTCC)		416-601-2147 (Rail) & 416-638-6776 (Bus)
CN Police / Railway		800-465-9239 (CN Railway) & 800-661-3963 (CN Police)
CP Police / Railway		800-716-9132
GO Transit Safety & Security		877-297-0642
Ontario OneCall		
Emergency Spill Response		

SECTION 6 - RISK ASSESSMENT (RA) AND SITE SAFETY

6.1 – REQUIRED CMO PERMITS

Check off all activities for which CMO work permits are required. NOTE: Append updated training records where applicable

	Activities	Regulatory Reference/ Additional Info
	Hot Work	O. Reg. 632/05, s.2
	Working requiring Fall protection	O. Reg. 297/13 <i>Note: Provide site specific fall rescue plan</i>
	Confined Space Entry	O. Reg. 632/05 Proof of Confined Space Training required <i>Note: Provide site specific CSE rescue plan</i>
	Trenching or Excavation	(1) Proof of Utility Locates (30 day validity) required for all contractors and subcontractors (1) Proof of MoL Trench Notice (Form 0070) may be required
	Crane/ or Hoist Operations	O. Reg. 213/91, s.150 Proof of Crane/ Hoisting Training required
	Tunnels , Shafts, Caissons or Cofferdam	O. Reg. 213/91, s.245 Proof of MoL Notification (Form 0077) required
	Designated Substances	O. Reg. 278/05, s.11 Proof of MoL Notification for Asbestos Removal Work (0072) may be required
	Site Visitor	Any visitor(s) access must be approved by CMO via the Site Visitor Permit.
	Shut Down (HVAC, electric power, fire alarm & sensors, fire suppression)	Permit required for all operations affecting building occupants and fire safety
	Electrical Work (live or not)	Permit required for work on or around equipment (live or not).

6.2 – EMERGENCY RESCUE PLANS

*Provide detailed rescue procedures in the event of fall from **working at heights** (O. Reg. 213/91); in the event where a worker needs to be extracted from a **confined space** (O. Reg. 632/05) and; where **trench work** is deeper than 2.4 meters (O. Reg. 213/91). Provide details/sketches in the available space below or as an attachment to this work plan with reference made in Section 5.*

SECTION 6.3 - RISK ASSESSMENT MATRIX

		Risk Scoring Criteria	Likelihood				
			Very Unlikely	Less than Likely	Likely	More than Likely	Very Likely
			All viable controls in place, no major contributing factors identified, but risk occurrence cannot be ruled out	Strong control in place with a few contributing factors exist	Some controls in place and some contributing factors exist	Limited controls in place and substantial contributing factors exist	A few weak controls in place and several contributing factors
			<10% but not 0% to occur	10% to <40% to occur	40% to <60% to occur	60% to <90% to occur	≥90% but not 100% to occur
			1	2	3	4	5
Severity	Very High	<ul style="list-style-type: none"> Major Service Delay > 1 hr. (repeated/several weeks) Loss of Service > 8 hrs. Major Station**/Facility Impact or Closure > 8 hrs. Fatality Widespread/offsite environmental contamination (>1 year cleanup) Damage to property > \$10,000,000 Irreversible equipment damage, unable to operate 	5 Medium	10 Medium	15 Elevated	20 High	25 High
	High	<ul style="list-style-type: none"> Major Service Delay > 1hr. (repeated/multiple weeks) or one delay of several hours Loss of Service 1 to 8 hrs. Major Station**/Facility Impact or Closure 1 to 8 hrs. Minor Station*/Facility Impact or Closure > 8 hrs. or closure of multiple Critical injury Localized environmental contamination (≤ 1 year cleanup) Damage to property \$1,000,000 to \$10,000,000 Substantial equipment damage, significant downtime due to repairs needed 	4 Low	8 Medium	12 Elevated	16 Elevated	20 High
	Moderate	<ul style="list-style-type: none"> Major Service Delay > 1 hr. (repeated/week) or (once/peak period) Minor Service Delay 30 to 60 mins. (repeated/multiple weeks) or (repeated peak period/week) Loss of Service ≤ 1 hr. Major Station**/Facility Impact or Closure ≤ 1 hr. Minor Station*/Facility Impact or Closure 1 to 8 hrs. Significant injury or worker lost time Significant effects on water quality/major damage to ecosystem (≤ 1 month cleanup) Damage to property \$100,000 to \$1,000,000 Moderate damage to equipment, downtime due to repairs needed 	3 Low	6 Medium	9 Medium	12 Elevated	15 Elevated
	Low	<ul style="list-style-type: none"> Major Service Delay > 1hr 1/week Minor Service Delay 30 to 60 mins. (repeated/week) Minor Station*/Facility Impact or Closure ≤ 1 hr. Minor Injury Localized impact to air/water/land (≤ 1 week cleanup) Damage to property \$10,000 to \$100,000 Minor Damage to equipment, minimal downtime due to repairs needed 	2 Low	4 Low	6 Medium	8 Medium	10 Medium
	Very Low	<ul style="list-style-type: none"> Minor Service Delay 30 to 60 mins. First aid Limited effects on air quality (≤ day to cleanup) Damage to property < \$10,000 	1 Low	2 Low	3 Low	4 Low	5 Medium

* A one-line station, ** A station with more than one line or a major support facility

SECTION 6.4 – RISK ASSESSMENT SUMMARY

Based on the Detailed Task Description stated in Section 3.3, populate the table below by listing the associated hazards of each task. Then determine the risk rating by evaluating the severity and likelihood of the hazard which poses a risk and/or consequences to safety, operations, environment etc.

- (1) The following is only a brief summary of instructions. Please review the WPMT user guideline for complete details for developing the Risk Assessment Summary table below.*
- (2) Re-list the task numbers and activity/task*
- (3) Provide a detailed account of all hazards associated to the activity/task*
- (3) Use the RA Matrix above:

 - (a) assign a **Severity** level (1 to 5) to the hazard by referencing the **Risk Scoring Criteria** which may best represent the consequence. Provision of other risks and/or consequences which are known to apply to a task can be added to best fit the scenario.*
 - (b) assign a **Likelihood** level (1 to 5) by referencing the qualitative and quantitative criteria which may best represent the risk/consequence occurring.*
 - (c) multiply **Severity x Likelihood** to obtain the **Risk** rating**
- (4) List the control measures to be put in place to reduce the initial uncontrolled **Risk** rating*
- (5) Repeat step (3) to re-evaluate the final controlled **Risk** rating with all appropriate control measures in place*
- (6) Complete Section 6.5 with the sign-off of all contributors to the Risk Assessment Summary*

Task No.	Activity/Task	Hazard / Risk / Consequence	(Initial) Uncontrolled Rating			Control Measure / Comment	(Final) Controlled Rating		
			Severity	Likelihood	Risk		Severity	Likelihood	Risk

SECTION 6.5 – RISK ASSESSMENT SIGN-OFF

NOTE: The development of this RA shall be produced by individuals with knowledge, experience and understanding of the work and associated hazards. This would include but not limited to the General Contractor, H&S Representatives, Sub-contractors etc. The names of the individuals who have contributed to the RA shall be listed below.

RA developed by (Name / Title):	Signature:	
RA developed by (Name / Title):	Signature:	
RA developed by (Name / Title):	Signature:	

**WORK PLAN METHODOLOGY TEMPLATE
CPG-PGM-FRM-277**

All Sections of the Work Plan Methodology Template (WPM) is to be filled by the Contractor except for Section 2. Project Delivery Team and/or Consultant to verify the contents of the form.

SECTION 1 - COVER PAGE

SECTION 1.1 - WORK OVERVIEW

Work Plan Name		Project Name	
Work Plan Number		Project Number	
Work Plan Revision No.		Contract Number	
Contractor		Subdivision	
WPM Author		Mileage Limits (Start and End)	
Metrolinx PDT Contact		Corridor	
Consultant / Technical Advisor		Competent Supervisor	
Major or Minor Work		Shifts (Day / Night / Continuous)	
Work Start	Date	Work End	Date
	Time (24hr)		Time (24hr)
Total Work Duration (Hours)		Total Number of Work Days / Nights	
Track Protection Requested		Track Work Block Requested	
Comments on Work Duration			

Dates are displayed in Day / Month / Year format and times are displayed in Military Time format (range 0000 to 2359). Disclaimer: Calculated total work duration and total number of work days/nights are estimates and are subject to Metrolinx's operational restrictions.

SECTION 1.2 - SUBMISSION STAGE GATE

Stage No.	Stage Description	Work plan Submission Deadline	Work plan Submission Date	Submission Deadline Met / Missed	Work Plan Revision No.	Status (Reviewed, Review with Comments, Revise and Resubmit, Scope Change)
1	WPM Submittal (40 Days in advance of Track Block)					
2	WPM Review Finalized (21 Days prior to Track Block)					
3	WPM Final Approval (7 Days prior to Track Block, decision subject to change)					
4	Pre-block Meeting (4 Days in Advance of the Track Block)					
5	Support Staff Conference (24 Hrs. in Advance of the Track Block)					

Pre-Block Meeting and Support Staff Conference to conform to specifications outlined in Track Closures, Railway Track Construction, Temporary Track Protection and other related documents. Dates are displayed in Day / Month / Year format

SECTION 1.3 – CORRIDOR ACCESS

Who is the Constructor for this work?	
Has Corridor Access been granted for this work?	
Are there other works to be coordinated with in the work area?	

SECTION 2 - STAKEHOLDER DISTRIBUTION AND REVIEW

SECTION 2.1 - REVIEW LOG

This section is to be completed by the Project Delivery Team. Please identify the status of the WPM Review.

Stage Description	Work Plan Revision No.	Submission Date	Name of Reviewer	Status (Reviewed, Review with Comments, Revise and Resubmit)
WPM Submittal				
WPM Received and distributed by Contract Administrator				
WPM Reviewed by Consultant				
WPM Reviewed by CPG				
WPM Reviewed by ICHST				
WPM Reviewed by RCI				
WPM Review Finalized				

SECTION 2.2: STAKEHOLDERS

This section is to be completed by the Project Delivery Team. Please check stakeholders that are impacted by the work outlined in this WPM. Add any missing stakeholders where required.

Metrolinx Internal Stakeholders

Capital Projects Group(CPG) Project Delivery Team	For INFO	For Review	RCI Track and Structures	For INFO	For Review
CPG Track and Structures	For INFO	For Review	RCI Signals & Communications	For INFO	For Review
Rail Services	For INFO	For Review	RCI Bridges and Structures	For INFO	For Review
Rail Operations	For INFO	For Review	Community Services	For INFO	For Review
Integrated Construction Health and Safety Team	For INFO	For Review	Transit Safety	For INFO	For Review
Network Infrastructure Electrification	For INFO	For Review	Station Operations	For INFO	For Review
Network Infrastructure Signals	For INFO	For Review	Customer Communications	For INFO	For Review
Service Planning	For INFO	For Review	Bus Operations	For INFO	For Review
StratComm	For INFO	For Review		For INFO	For Review
	For INFO	For Review		For INFO	For Review

External Stakeholders (Railways)

Canadian National Railway (CN)	For INFO	For Review	VIA Rail	For INFO	For Review
Canadian Pacific Railway (CP)	For INFO	For Review	Amtrak	For INFO	For Review
Goderich-Exeter Railway (GEXR)	For INFO	For Review		For INFO	For Review

External Stakeholders (Other Transit, Cities, Townships, Governments, Public Interest)

	For INFO	For Review		For INFO	For Review
	For INFO	For Review		For INFO	For Review
	For INFO	For Review		For INFO	For Review

Regulators

Ministry of Environment (MOE)	For INFO	For Review	Transport Canada	For INFO	For Review
Toronto and Region Conservation (TRCA)	For INFO	For Review		For INFO	For Review
	For INFO	For Review		For INFO	For Review

Public Services

Fire Department	For INFO	For Review	Schools	For INFO	For Review
Emergency Medical Services (EMS)	For INFO	For Review	Police Department	For INFO	For Review
	For INFO	For Review		For INFO	For Review

External Stakeholders (Utility Companies - Crossings or Parallel to track within WPM limits)

Hydro	For INFO	For Review	BELL	For INFO	For Review
TransCanada (Pipelines)	For INFO	For Review	COGECO	For INFO	For Review
Enbridge	For INFO	For Review	Rogers	For INFO	For Review
Water Lines	For INFO	For Review	Storm Sewer Lines	For INFO	For Review
Sanitation Sewer Lines	For INFO	For Review		For INFO	For Review
	For INFO	For Review		For INFO	For Review

SECTION 3: MAIN CONTENT**SECTION 3.1 - STAKEHOLDER CONSIDERATIONS**

Construction work on Metrolinx / GO Property can impact services, operations and the public. The Contractor shall ensure that their work will not impact operations or put public safety at risk. In relation to the tasks, all mitigating measures to eliminate or reduce operational and public impacts shall be described here. Risks to operations and public shall be identified in detail and evaluated in Section 6 Risk Assessment (RA) and Site Safety. The Contractor shall allocate enough time to clean up site after completion of work, to make site safe for operations and the public.

Service and Operational Impact**Surrounding Community Impact**

Describe any impact the work can impose on the community in the surrounding area (such as noise, dust, traffic control). Inform if special signage for the operation will be posted where and which kind, who will provide the signage, etc. Direct all communications with the public through Metrolinx PDT.

Roadway and Private Property Impact

Describe any traffic control, road closures and private property encroachments that are required for the work. List all permits required for the work and confirm if they have been obtained. A Traffic Plan shall be appended, and identified in Section 5 Attachments and Personnel List.

SECTION 3.2 - SCOPE OF WORK

Please provide a description of the work to be completed, including all objectives that are to be accomplished. Please include any multi-disciplinary involvement.

SECTION 3.3 - DETAILED TASK DESCRIPTION (Gantt Chart to be Appended)

Provide a detailed description of the work, including pre-work and post-work activities, in a chronological order to be performed.

Task No.	Activity/Task	Task Location and Detailed Task Description	Start Date	Start Time	Duration
1					
2					
3					
4					
5					
6					
7					
8					
9					
10					
11					
12					
13					
14					
15					

SECTION 3.6 - SCHEDULE RISK DESCRIPTION

List the milestone tasks to be completed before the next task can be started.

List the outside influences, including Weather and General Public constraints (ex. Road Closures, Public Events, etc.)

Can the work be stopped halfway through?

Can the block be extended without impacting operations?

If any of the above responses are Yes, please explain:

SECTION 3.7 - CONTINGENCY PLAN

Please identify and list additional resources that can be utilized if required

Please identify the amount of hours allocated to contingency:

Please provide the contingency plan for each milestone:

SECTION 3.8 - POINT OF NO RETURN DECISION (GO OR NO GO)

Recovery Plan to be appended with the WPM.

Critical Milestone	Meeting Location, Time and Date	Rail Operations Notified	Stakeholders Notified

Point of No Return	<i>Describe when the point of no return is reached in the schedule. Provide a date and time for the point of no return.</i>
How is the Decision Made	<i>Describe in detail exactly who makes the call and when it is to happen. Who from the contractor is allowed to make the call? Who from the stakeholders should be consulted?</i>
What Influences this Decision?	<i>Describe the influences that trigger the point of no return. (Examples: Weather, delay in pre-work, service disruption, funding, schedule, etc.)</i>

SECTION 3.9 - TRACK BLOCK

Identify Tracks Required for Track Block. Please see the accompanying document for the WPM which describes each block type.

Type of Track Block	Partial Block	Split Block	Total Block
Multi-Track	Single Track	Other Railroads?	
List the tracks required:		Location	
From Mileage		To Mileage	
Length of time required to complete work:			
Length of time available to complete the work:			
If time required is greater than time available, can the work be completed in stages?			

SECTION 3.10 - TRACK PROTECTION

Identify which company will provide flagging from the list below and Identify as Track Flagging and / or Signals Support

Track Protection	Track or Signals		Track Protection	Track or Signals	
A&B Rail	Track Flagging	Signals Support	GEXR	Track Flagging	Signals Support
TTR		Signals Support	CNR	Track Flagging	Signals Support
PNR	Track Flagging	Signals Support	CPR	Track Flagging	Signals Support
	Track Flagging	Signals Support		Track Flagging	Signals Support

When will the flagman be on site?		Is flagging continuous?	
When will the flagman leave site?			

SECTION 5.5 - EXTERNAL CONTACT LIST (add all required personnel)

Role	Name	Phone Number
Contract Administrator		
Contract Administrator		
Contract MTCE Provider Superintendent		
Contract MTCE Provider Track Supervisor		
Contract MTCE Provider Inspector		

SECTION 5.6 - METROLINX CONTACT LIST (add all required personnel)

Role	Name	Phone Number
Metrolinx Project Manager(CPG)		
Metrolinx Project Coordinator(CPG)		
RCI Track Specialist		
RCI Signal Specialist		
RCI Bridges & Structures Specialist		

SECTION 5.7 - EMERGENCY CONTACT LIST

Role	Name	Phone Number
Nearest Hospital		
Emergency Services		911
GO CMO Emergency		416-601-3611
GO Transit Control Centre(GTCC)		416-601-2147 (Rail) & 416-638-6776 (Bus)
CN Police / Railway		800-465-9239 (CN Railway) & 800-661-3963 (CN Police)
CP Police / Railway		800-716-9132
GO Transit Safety & Security		877-297-0642
Ontario OneCall		
Emergency Spill Response		

SECTION 6 - RISK ASSESSMENT (RA) AND SITE SAFETY

6.1 – REQUIRED CMO PERMITS

Check off all activities for which CMO work permits are required. NOTE: Append updated training records where applicable

	Activities	Regulatory Reference/ Additional Info
	Hot Work	O. Reg. 632/05, s.2
	Working requiring Fall protection	O. Reg. 297/13 <i>Note: Provide site specific fall rescue plan</i>
	Confined Space Entry	O. Reg. 632/05 Proof of Confined Space Training required <i>Note: Provide site specific CSE rescue plan</i>
	Trenching or Excavation	(1) Proof of Utility Locates (30 day validity) required for all contractors and subcontractors (1) Proof of MoL Trench Notice (Form 0070) may be required
	Crane/ or Hoist Operations	O. Reg. 213/91, s.150 Proof of Crane/ Hoisting Training required
	Tunnels , Shafts, Caissons or Cofferdam	O. Reg. 213/91, s.245 Proof of MoL Notification (Form 0077) required
	Designated Substances	O. Reg. 278/05, s.11 Proof of MoL Notification for Asbestos Removal Work (0072) may be required
	Site Visitor	Any visitor(s) access must be approved by CMO via the Site Visitor Permit.
	Shut Down (HVAC, electric power, fire alarm & sensors, fire suppression)	Permit required for all operations affecting building occupants and fire safety
	Electrical Work (live or not)	Permit required for work on or around equipment (live or not).

6.2 – EMERGENCY RESCUE PLANS

*Provide detailed rescue procedures in the event of fall from **working at heights** (O. Reg. 213/91); in the event where a worker needs to be extracted from a **confined space** (O. Reg. 632/05) and; where **trench work** is deeper than 2.4 meters (O. Reg. 213/91). Provide details/sketches in the available space below or as an attachment to this work plan with reference made in Section 5.*

SECTION 6.3 - RISK ASSESSMENT MATRIX

		Risk Scoring Criteria	Likelihood				
			Very Unlikely	Less than Likely	Likely	More than Likely	Very Likely
			All viable controls in place, no major contributing factors identified, but risk occurrence cannot be ruled out	Strong control in place with a few contributing factors exist	Some controls in place and some contributing factors exist	Limited controls in place and substantial contributing factors exist	A few weak controls in place and several contributing factors
			<10% but not 0% to occur	10% to <40% to occur	40% to <60% to occur	60% to <90% to occur	≥90% but not 100% to occur
			1	2	3	4	5
Severity	Very High	<ul style="list-style-type: none"> Major Service Delay > 1 hr. (repeated/several weeks) Loss of Service > 8 hrs. Major Station**/Facility Impact or Closure > 8 hrs. Fatality Widespread/offsite environmental contamination (>1 year cleanup) Damage to property > \$10,000,000 Irreversible equipment damage, unable to operate 	5 Medium	10 Medium	15 Elevated	20 High	25 High
	High	<ul style="list-style-type: none"> Major Service Delay > 1hr. (repeated/multiple weeks) or one delay of several hours Loss of Service 1 to 8 hrs. Major Station**/Facility Impact or Closure 1 to 8 hrs. Minor Station*/Facility Impact or Closure > 8 hrs. or closure of multiple Critical injury Localized environmental contamination (≤ 1 year cleanup) Damage to property \$1,000,000 to \$10,000,000 Substantial equipment damage, significant downtime due to repairs needed 	4 Low	8 Medium	12 Elevated	16 Elevated	20 High
	Moderate	<ul style="list-style-type: none"> Major Service Delay > 1 hr. (repeated/week) or (once/peak period) Minor Service Delay 30 to 60 mins. (repeated/multiple weeks) or (repeated peak period/week) Loss of Service ≤ 1 hr. Major Station**/Facility Impact or Closure ≤ 1 hr. Minor Station*/Facility Impact or Closure 1 to 8 hrs. Significant injury or worker lost time Significant effects on water quality/major damage to ecosystem (≤ 1 month cleanup) Damage to property \$100,000 to \$1,000,000 Moderate damage to equipment, downtime due to repairs needed 	3 Low	6 Medium	9 Medium	12 Elevated	15 Elevated
	Low	<ul style="list-style-type: none"> Major Service Delay > 1hr 1/week Minor Service Delay 30 to 60 mins. (repeated/week) Minor Station*/Facility Impact or Closure ≤ 1 hr. Minor Injury Localized impact to air/water/land (≤ 1 week cleanup) Damage to property \$10,000 to \$100,000 Minor Damage to equipment, minimal downtime due to repairs needed 	2 Low	4 Low	6 Medium	8 Medium	10 Medium
	Very Low	<ul style="list-style-type: none"> Minor Service Delay 30 to 60 mins. First aid Limited effects on air quality (≤ day to cleanup) Damage to property < \$10,000 	1 Low	2 Low	3 Low	4 Low	5 Medium

* A one-line station, ** A station with more than one line or a major support facility

SECTION 6.4 – RISK ASSESSMENT SUMMARY

Based on the Detailed Task Description stated in Section 3.3, populate the table below by listing the associated hazards of each task. Then determine the risk rating by evaluating the severity and likelihood of the hazard which poses a risk and/or consequences to safety, operations, environment etc.

- (1) The following is only a brief summary of instructions. Please review the WPMT user guideline for complete details for developing the Risk Assessment Summary table below.*
- (2) Re-list the task numbers and activity/task*
- (3) Provide a detailed account of all hazards associated to the activity/task*
- (3) Use the RA Matrix above:

 - (a) assign a **Severity** level (1 to 5) to the hazard by referencing the **Risk Scoring Criteria** which may best represent the consequence. Provision of other risks and/or consequences which are known to apply to a task can be added to best fit the scenario.*
 - (b) assign a **Likelihood** level (1 to 5) by referencing the qualitative and quantitative criteria which may best represent the risk/consequence occurring.*
 - (c) multiply **Severity x Likelihood** to obtain the **Risk** rating**
- (4) List the control measures to be put in place to reduce the initial uncontrolled **Risk** rating*
- (5) Repeat step (3) to re-evaluate the final controlled **Risk** rating with all appropriate control measures in place*
- (6) Complete Section 6.5 with the sign-off of all contributors to the Risk Assessment Summary*

Task No.	Activity/Task	Hazard / Risk / Consequence	(Initial) Uncontrolled Rating			Control Measure / Comment	(Final) Controlled Rating		
			Severity	Likelihood	Risk		Severity	Likelihood	Risk

SECTION 6.5 – RISK ASSESSMENT SIGN-OFF

NOTE: The development of this RA shall be produced by individuals with knowledge, experience and understanding of the work and associated hazards. This would include but not limited to the General Contractor, H&S Representatives, Sub-contractors etc. The names of the individuals who have contributed to the RA shall be listed below.

RA developed by (Name / Title):	Signature:	
RA developed by (Name / Title):	Signature:	
RA developed by (Name / Title):	Signature:	

NOTE: Per Schedule 34, applications for a Major Track Closure Permit are to be submitted no later than 80 business days prior to the desired date for the applicable Major Track Closure Permit.	
Project Name	Project Number
Project Co.	Submission Date
Project Co.'s Representative (Name)	Project Co.'s Representative Contact Number
Project Phase (refer back to Rail Corridor Access Plan)	

PART A: TRACK PROTECTION

Proposed Date, Time and Duration	
Access Location and Location of Work (with reference to nearest rail)	
Equipment	
Work Type and Scope	
Workforce (# of workers)	
Required Training	
Emergency Procedures and Contingency Plan	<i>Please attach site-specific emergency procedures / measures and contingency arrangements that Project Co. proposes to apply in the case of an accident, incident or delay that may affect public and operations.</i>

PART B: MAJOR TRACK CLOSURE

B.1 Required Adjustments to Rail Service
<i>Provide a detailed list of required adjustments to rail service on the applicable Rail Corridor</i>

B.2 Planned Works
<i>Provide a description of the background of planned works and the reason why the performance of the works is required</i>

B.3 Performance of Planned Works
<i>Provide an explanation of the timing of the performance of the works and why the performance of the works is required on the weekend</i>

PART C: DETAILED CONSTRUCTION WORK PLAN

Detailed Construction Work Plan
<i>In accordance with Schedule 34, section 5.4(d), submit a "Detailed Construction Work Plan" no later than 40 Business Days prior to the desired date for the applicable Major Track Closure</i>

NOTE: A Rail Corridor Access Permit does not, by itself, authorize Project Co. to carry out the Works and is subject to receiving a Flagging Request Confirmation.

Per Schedule 34, applications for a Minor Track Closure Permit are to be submitted no later than 42 business days prior to the desired date for the applicable Minor Track Closure Permit.

Project Name	Project Number
Project Co.	Submission Date
Project Co.'s Representative (Name)	Project Co.'s Representative Contact Number
Project Phase (refer back to Rail Corridor Access Plan)	

PART A: TRACK PROTECTION

Proposed Date, Time and Duration	
Access Location and Location of Work (with reference to nearest rail)	
Equipment	
Work Type and Scope	
Workforce (# of workers)	
Required Training	
Emergency Procedures and Contingency Plan	<i>Please attach site-specific emergency procedures / measures and contingency arrangements that Project Co. proposes to apply in the case of an accident, incident or delay that may affect public and operations.</i>

PART B: MINOR TRACK CLOSURE

Track and Track Infrastructure
<i>Submit a plan for ensuring that track and track infrastructure are put back into service in accordance with the Rail Corridor Handover Protocol including details of methods and personnel to be used</i>

NOTE: A Rail Corridor Access Permit does not, by itself, authorize Project Co. to carry out the Works and is subject to receiving a Flagging Request Confirmation.

Per Schedule 34, applications for a Track Protection Access Permit are to be submitted no later than 42 business days prior to the desired date for the applicable Track Protection Access Permit.

Project Name	Project Number
Project Co.	Submission Date
Project Co.'s Representative (Name)	Project Co.'s Representative Contact Number
Project Phase (refer back to Rail Corridor Access Plan)	

Proposed Date, Time and Duration	
Access Location and Location of Work (with reference to nearest rail)	
Equipment	
Work Type and Scope	
Workforce (# of workers)	
Required Training	
Emergency Procedures and Contingency Plan	<i>Please attach site-specific emergency procedures / measures and contingency arrangements that Project Co. proposes to apply in the case of an accident, incident or delay that may affect public and operations.</i>

NOTE: A Rail Corridor Access Permit does not, by itself, authorize Project Co. to carry out the Works and is subject to receiving a Flagging Request Confirmation.

<i>Per Schedule 34, applications for a Track Protection Barrier Access Permit are to be submitted no later than 42 business days prior to the desired date for the applicable Track Protection Barrier Access Permit.</i>	
Project Name	Project Number
Project Co.	Submission Date
Project Co.'s Representative (Name)	Project Co.'s Representative Contact Number
Project Phase (refer back to Rail Corridor Access Plan)	

PART A: TRACK PROTECTION

Proposed Date, Time and Duration	
Access Location and Location of Work (with reference to nearest rail)	
Equipment	
Work Type and Scope	
Workforce (# of workers)	
Required Training	
Emergency Procedures and Contingency Plan	<i>Please attach site-specific emergency procedures / measures and contingency arrangements that Project Co. proposes to apply in the case of an accident, incident or delay that may affect public and operations.</i>

PART B: TRACK PROTECTION BARRIER ACCESS

Task-Specific Risk Assessment

Please attach a task-specific risk assessment for the installation of railway-approved temporary barriers, enclosures or platforms

See Risk Assessment Submittal Guideline

NOTE: A Rail Corridor Access Permit does not, by itself, authorize Project Co. to carry out the Works and is subject to receiving a Flagging Request Confirmation.

Project Information

Project Name:	Project Number:	Project Description:
Project Group or Owner:		
Summary (scope of work and timelines):		
Subdivision:	Actual work location (mile marker):	Requested work limits (mile markers):
Hours of Work Required:	Planned Work Start Date:	
Requirements for Protection:		
<input type="checkbox"/> Track Occupancy Permit <input type="checkbox"/> Rule 842 <input type="checkbox"/> Safety Watch <input type="checkbox"/> Other:		

Contact Information

Metrolinx Project Manager:	Phone:	Email:
Contractor Contact & Company (if known):	Phone:	Email:

Operational Impacts Checklist

Yes	No	
<input type="checkbox"/>	<input type="checkbox"/>	Planned slow order after workblock completion, if known please specify speed: _____ mph and duration _____
<input type="checkbox"/>	<input type="checkbox"/>	Rule "103g" required after workblock completion (If at a public crossing)
<input type="checkbox"/>	<input type="checkbox"/>	Will signals be affected
<input type="checkbox"/>	<input type="checkbox"/>	Will there be any impact to train operations
<input type="checkbox"/>	<input type="checkbox"/>	Delay code: _____
<input type="checkbox"/>	<input type="checkbox"/>	Other (please specify):

Additional Notes

Submitted By:	Date Submitted:
---------------	-----------------

Project Information

Project Name:	Project Number:	Project Description:
Project Group or Owner:		
Summary (scope of work and timelines):		
Subdivision:	Actual work location (mile marker):	Requested work limits (mile markers):
Hours of Work Required:	Planned Work Start Date:	
Requirements for Protection:		
<input type="checkbox"/> Track Occupancy Permit <input type="checkbox"/> Rule 842 <input type="checkbox"/> Safety Watch <input type="checkbox"/> Other:		

Contact Information

Metrolinx Project Manager:	Phone:	Email:
Contractor Contact & Company (if known):	Phone:	Email:

Operational Impacts Checklist

Yes	No	
<input type="checkbox"/>	<input type="checkbox"/>	Planned slow order after workblock completion, if known please specify speed: _____ mph and duration _____
<input type="checkbox"/>	<input type="checkbox"/>	Rule "103g" required after workblock completion (If at a public crossing)
<input type="checkbox"/>	<input type="checkbox"/>	Will signals be affected
<input type="checkbox"/>	<input type="checkbox"/>	Will there be any impact to train operations
<input type="checkbox"/>	<input type="checkbox"/>	Delay code: _____
<input type="checkbox"/>	<input type="checkbox"/>	Other (please specify):

Additional Notes

Submitted By:	Date Submitted:
---------------	-----------------

SCHEDULE 35

CONTRACTOR SITE SPECIFIC SAFETY MANUAL REQUIREMENTS

1. GENERAL REQUIREMENTS

1.1 The Contractor Site Specific Safety Manual shall, at a minimum, comply in all respects with:

- (a) all applicable requirements of the *Occupational Health and Safety Act* (Ontario);
- (b) industry best practices;
- (c) health and safety requirements set by Project Co with respect to the Project and the Site, and
- (d) health and safety requirements of the Project Agreement.

2. MINIMUM CATEGORIES

2.1 The Contractor Site Specific Safety Manual shall, at a minimum, contain narrative addressing the categories and sub-categories as set out in this Section 2.

1.0	Overview and Scope The manual shall have an introduction that shall set out an overview and scope of the Project.
2.0	Health and Safety Statement A statement that shall refer to the safety goals of the project and the culture of safety planned to be implemented by the Construction Contractor.
2.1	Statement of Commitment by an Officer: this statement shall specifically refer to the manual itself and be executed by an officer of the Construction Contractor with authority to bind the Construction Contractor.
2.2	Project Company Mandate and OHS Policy
2.3	Statement of Commitment Regarding keeping Subcontractors Responsible
2.4	Site Plot Plan: which shall include an illustration.
3.0	Project Health and Safety Objectives and Performance Measurement Description of methodology for measuring health and safety performance, including key performance indicators to assess whether objectives are being met.

4.0	Roles and Responsibilities Description of the specific roles and responsibilities of the following individuals/entities in relation to meeting the health and safety objectives.
4.1	Project Co.
4.2	Project Director
4.3	Safety Manager
4.4	Construction Manager
4.5	Safety Coordinator
4.6	Joint Occupational Health and Safety Committee/Trades Committee
4.7	Subcontractor
4.8	Subcontractor Supervisor
4.9	Workers
4.10	Visitors
4.11	External Parties
4.12	Contact Sheet
5.0	Sub-contractor Health and Safety Management Plan
6.0	Health and Safety Training & Competency Description of the training program to be implemented to ensure that all persons who will be entering and/or working on the Site are appropriately trained.
6.1	Site Specific Orientation
6.2	Project Specific Orientation
6.3	Worker Training to Specific Site Hazards
6.4	Visitor/Short Duration Work Orientation
6.5	Personal Protective Equipment: identify the minimum PPE that will be required on-site)
6.6	Delivery Driver/Supplier Orientation

6.7	Worker/ Supervisor Competency and Evaluation: describe how competency of workers and supervisors will be identified, met and evaluated on an on-going basis.
7.0	Meetings and Communication Plan Description of frequency of meetings relating to health and safety, how meetings will be documented and how agreed outcomes will be communicated to the appropriate parties.
8.0	Emergency Response Plan Description of measures to respond to injuries and accidents.
8.1	Emergency Contacts and Roles
8.2	Emergency Evacuation Plan
8.3	Emergency Response Procedure
8.4	Property, Equipment and Environmental Damage Procedure
8.5	First Aid
8.6	Drills and Exercises
9.0	Inspections and Audits Description of the Construction Contractor’s strategy for implementing an inspection regime in relation to health and safety on the Site.
9.1	Informal Inspections
9.2	Formal Inspections
9.3	Audits
9.4	Inspection and Audit Schedule
9.5	Inspection Follow-up/Corrections Action Plan
9.6	Maintenance of Records
10.0	Incident Reporting and Investigations Procedure Description of the procedure for reporting incidents, proactive investigations intended to prevent future incidents and measures to resolve the incident.

11.0	Rules of Conduct and Disciplinary Actions Description of disciplinary actions to be taken in the case of health and safety infractions.
11.1	Drugs and Alcohol
11.2	Workplace Violence and Harassment
11.3	Disciplinary Action
11.4	Workers' Rights
12.0	Security Plan Provision of a plan that details guidelines for implementing safety on the Site.
12.1	Methodology for Securing the Site and Restricting Trespassers
13.0	Hazard Identification and Control
13.1	Hazard Identification and Control
13.2	Designated Substances
13.3	Task Safety Analysis
13.4	Job Hazard Analysis: analysis to detail a technique that focuses on job tasks as a way to identify hazards before they occur. It focuses on the relationship between the worker, the task, the tools, and the work environment. It breaks down the job in smaller steps to examine potential hazards and potential preventative steps.
13.5	Project Specific Health and Safety Requirements: provide a project-specific health and safety risk register which details any unique safety requirements of the Project.
14.0	Traffic Management and Control Plan
15.0	Others